



## WE'RE MAKING OUR PACKAGING MORE SUSTAINABLE

We're transitioning from single-use plastic to paper-based packaging. As we progress, you may find a mix of paper and plastic in our boxes.

## NOUS RENDONS NOS EMBALLAGES PLUS DURABLES

Nous passons des emballages en plastique à usage unique aux emballages à base de papier. Durant la transition, vous pourriez trouver un mélange de papier et de plastique dans nos boîtes.

## QUEREMOS HACER MÁS SUSTENTABLES NUESTROS MATERIALES DE EMBALAJE

Estamos cambiando las bolsas de plástico desechables por bolsas con base de papel. Conforme avanzamos en este propósito, puedes encontrar una mezcla de papel y de plástico en nuestras cajas.

[LEGO.com/sustainable-packaging](https://LEGO.com/sustainable-packaging)

# LEGO® VIP

- 1.** SIGN UP  
INSCRIVEZ-VOUS  
REGÍSTRATE

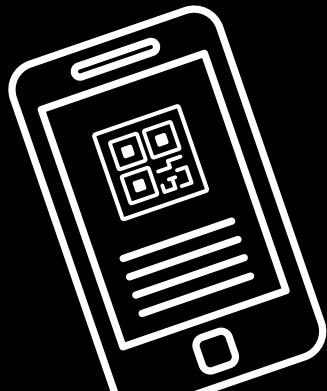

- 2.** EARN POINTS  
FOR PURCHASES  
GAGNEZ DES POINTS  
POUR VOS ACHATS  
GANA PUNTOS POR  
TUS COMPRAS

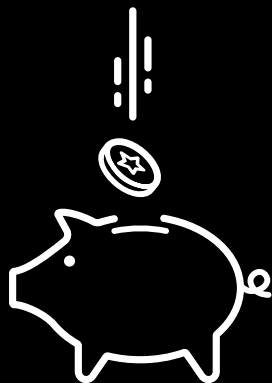

- 3.** REDEEM POINTS FOR REWARDS, EXPERIENCES,  
DISCOUNTS & MORE  
ÉCHANGEZ DES POINTS CONTRE DES RÉCOMPENSES,  
DES EXPÉRIENCES, DES RÉDUCTIONS ET PLUS ENCORE  
CANJEA PUNTOS POR RECOMPENSAS, EXPERIENCIAS,  
DESCUENTOS Y MUCHO MÁS

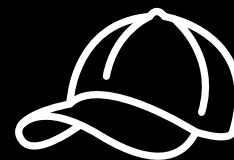
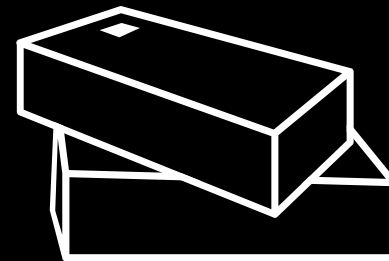
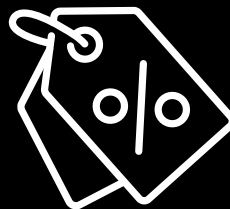

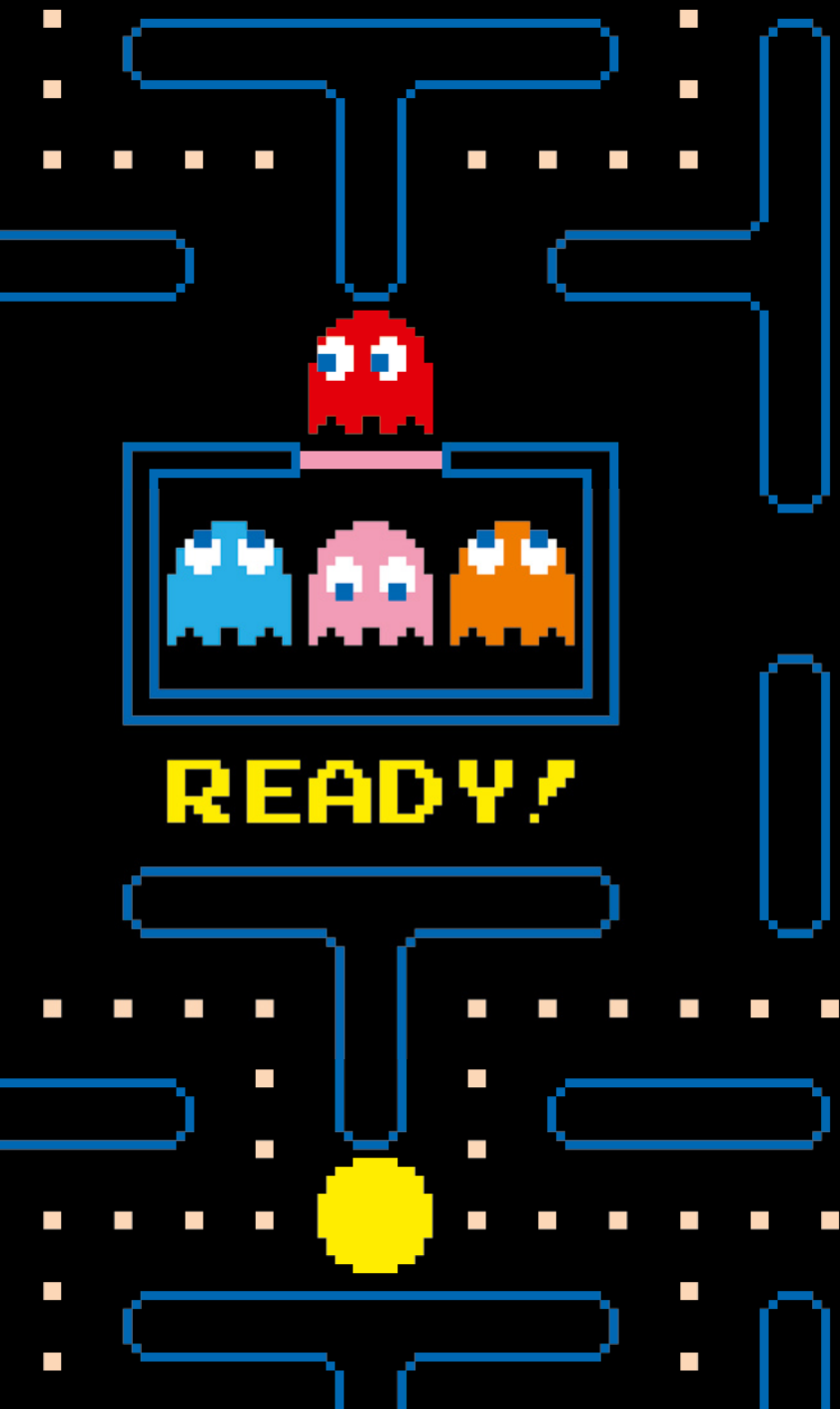



## LOVE AT FIRST BITE

 When the first digital arcade games were introduced in Japan in the 1970s, they took the country by storm. Soon after, the rest of the world caught wind and players flocked to dimly lit game centers everywhere, enticed by flickering pixels, mechanical music and the alluring high score. Shooting games were the most popular – and often only – choices and catered mainly to a male audience. Japanese Game Designer Toru Iwatani posed that women might also enjoy playing games, if the environments were more inviting and the gameplay a little friendlier. After exploring alternative game themes like fashion and fortune telling, Mr. Iwatani chose the ultimate socially inclusive theme: food.

## UN FESTIN POUR LES YEUX

 Lorsque les premiers jeux d'arcade numériques ont fait leur apparition au Japon dans les années 1970, ils ont pris le pays d'assaut. Peu de temps après, le reste du monde a été conquis et les joueurs ont afflué dans les centres de jeux mal éclairés du monde entier, attirés par les pixels clignotants, la musique mécanique et la possibilité d'atteindre le meilleur score. Les jeux de tir étaient les plus populaires (et souvent les seuls) et s'adressaient principalement à un public masculin. Le concepteur de jeux japonais Toru Iwatani a estimé que les femmes pourraient également aimer jouer à des jeux, si l'environnement était plus accueillant et la jouabilité, un peu plus conviviale. Après avoir envisagé d'autres thèmes de jeu, comme la mode et la voyance, M. Iwatani a choisi le thème inclusif par excellence : la nourriture.

## AMOR A PRIMERA MORDIDA

 Cuando los primeros juegos de arcade digitales entraron a Japón en la década de 1970, fueron un éxito rotundo en el país. Poco después, el resto de la humanidad se contagió y los jugadores acudieron en masa a los centros de juego de todo el mundo, con su característica poca iluminación, atraídos por los píxeles parpadeantes, la música mecánica y la competencia por la puntuación más alta. Los juegos de disparos eran los más populares (y a menudo los únicos) y se dirigían principalmente a un público masculino. El diseñador de juegos japonés Toru Iwatani planteó que las mujeres también podrían disfrutar de los juegos, si los entornos fueran más acogedores y la jugabilidad un poco más accesible. Luego de explorar algunos temas alternativos para los juegos como la moda y la adivinación, el Sr. Iwatani eligió el tema socialmente más inclusivo: la comida.



## THE INSPIRATION

🍕 One day, as he was working on game ideas, he grabbed a slice of pizza. In the remaining pie, he saw the shape of a simple iconic figure with its mouth open. The idea for PAC-MAN was born.

The game's original name, Puck Man, was inspired by the Japanese phrase "Paku paku taberu" which means gobbling up or devouring food. When the game was launched in the US, the distributor found that PAC-MAN would be a more suitable name for the market. Mr. Iwatani also shared an episode where he referred to the yellow color of LEGO® bricks when he chose the color of PAC-MAN. He chose LEGO yellow because he thought his target customers – women and kids – would feel more comfortable with its warmer color.

## L'INSPIRATION

🍕 Un jour, alors qu'il travaille sur des idées de jeux, il prend une pointe de pizza. Dans le reste de la pizza, il voit la forme d'une simple silhouette avec la bouche ouverte. L'idée de PAC-MAN était née.

Le nom original du jeu, Puck Man, est inspiré de l'expression japonaise « Paku paku taberu », qui signifie engloutir ou dévorer la nourriture. Lorsque le jeu a été lancé aux États-Unis, le distributeur a estimé que PAC-MAN serait un nom plus adapté au marché.

M. Iwatani a également révélé qu'il s'était servi de la couleur jaune des briques LEGO® pour choisir la couleur de PAC-MAN. Il a choisi le jaune LEGO parce qu'il pensait que ses clients cibles, les femmes et les enfants, seraient plus à l'aise avec cette couleur plus chaude.

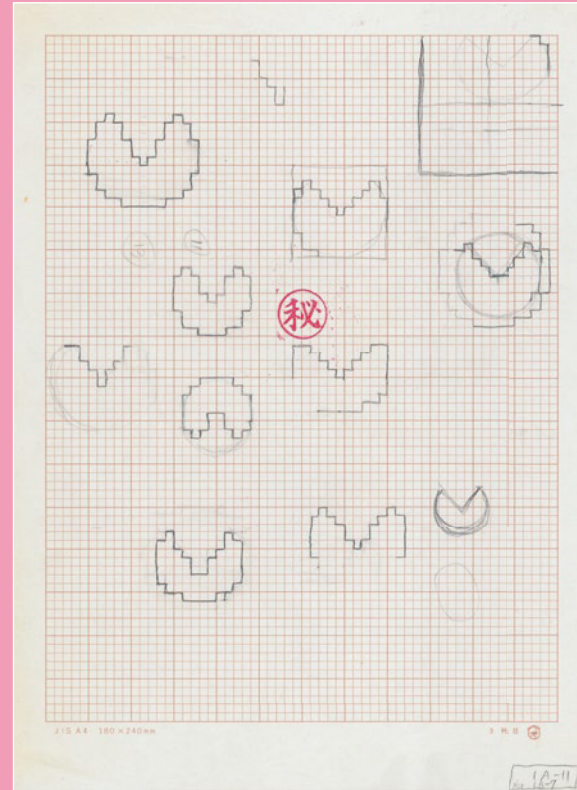

Toru Iwatani

*Iwatani's original Puck Man design sketches on graph paper were used to plot the pixels on a 16x16 pixel grid.*

*Les croquis originaux de Puck Man réalisés par Iwatani sur du papier millimétré ont été utilisés pour tracer les pixels sur une grille de 16x16 pixels.*

*Para trazar los píxeles en una cuadrícula de 16 x 16 se utilizaron los bocetos originales del Puck Man de Iwatani en papel cuadriculado.*

## LA INSPIRACIÓN

🍕 Un día, mientras trabajaba en algunas ideas para juegos, tomé una rebanada de pizza. En los pedazos restantes, vi la forma de una simple figura icónica con la boca abierta. Así nació la idea de PAC-MAN.

El nombre original del juego, Puck Man, se inspiró en la frase japonesa *Paku paku taberu*, que significa 'engullir' o 'devorar comida'. Cuando el juego se lanzó en EE. UU., el distribuidor consideró que el nombre PAC-MAN sería más adecuado para el mercado.

El Sr. Iwatani también habló en una ocasión de que el color amarillo de los bricks LEGO® fue su referencia al elegir el color de PAC-MAN. Escogió el amarillo LEGO porque pensó que sus clientes objetivo (mujeres y niños) se sentirían más cómodos con su calidez.

## A GLOBAL GAMING PHENOMENON



🍒 Mr. Iwatani's theory was proven right beyond his wildest imagination. Soon after the first PAC-MAN arcade game was released in 1980, it grew into an unprecedented global phenomenon. The game instantly appealed to new audiences who might never have considered visiting a gaming arcade. The cute characters and intuitive gameplay won the hearts of every generation. For the first time, women, men, kids, teens and grandparents could share a family-friendly digital gaming experience. With more than 300,000 consoles sold in the first decade, the game grossed \$2.5 billion US by the turn of the century, and it still holds the record as the most popular arcade game to date.



## UN PHÉNOMÈNE MONDIAL DU JEU VIDÉO

🍌 La théorie de M. Iwatani s'est avérée juste au-delà de ses rêves les plus fabuleux. Peu après sa sortie en 1980, le premier jeu d'arcade PAC-MAN est devenu un phénomène mondial sans précédent. Le jeu a instantanément séduit de nouveaux publics qui n'auraient jamais envisagé de visiter une salle d'arcade. Ses personnages mignons et sa jouabilité intuitive ont conquis le cœur de toutes les générations. Pour la première fois, femmes, hommes, enfants, adolescents et grands-parents pouvaient partager une expérience de jeu numérique familiale. Avec plus de 300 000 consoles vendues au cours de la première décennie, le jeu avait rapporté 2,5 milliards de dollars américains à la fin du siècle, et il détient toujours le record du jeu d'arcade le plus populaire à ce jour.

## UN FENÓMENO GLOBAL DE LOS VIDEOJUEGOS

🍓 La teoría del Sr. Iwatani resultó ser acertada más allá de lo que imaginó. Poco después de su lanzamiento en 1980, el primer juego de arcade de PAC-MAN se convirtió en un fenómeno mundial como jamás se había visto. El juego atrajo instantáneamente a un nuevo público que tal vez nunca hubiera pensado en visitar una sala de videojuegos. Sus simpáticos personajes y su jugabilidad intuitiva conquistaron los corazones de cada generación. Por primera vez, mujeres, hombres, niños, adolescentes y abuelos pudieron compartir una experiencia de videojuegos para toda la familia. Con más de 300.000 consolas vendidas en la primera década, el juego recaudó 2500 millones de dólares en EE. UU. a finales de siglo, y sigue ostentando el récord de juego de arcade más popular hasta la fecha.



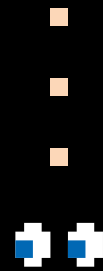

## WHAT HAPPENS ON LEVEL 256 STAYS ON LEVEL 256

🍒 Mr. Iwatani and his team of developers never imagined anyone playing beyond 256 levels – in fact, the game wasn't even designed to have an ultimate end goal or victory scene. By the time you reach level 256, there is not enough memory left to generate a full board and your journey through PAC-MAN's maze ends here. (Unless you start over, of course.)

## CE QUI SE PASSE AU NIVEAU 256 RESTE AU NIVEAU 256

🍓 M. Iwatani et son équipe de développeurs n'ont jamais imaginé que quelqu'un puisse jouer au-delà de 256 niveaux. En fait, la conception du jeu ne prévoit même pas d'objectif final ou de scène de victoire. Au moment où vous atteignez le niveau 256, il ne reste plus assez de mémoire pour générer un tableau complet et votre voyage dans le labyrinthe de PAC-MAN s'arrête là. (Sauf si vous recommencez, bien sûr.)

## LO QUE PASA EN EL NIVEL 256 SE QUEDA EN EL NIVEL 256

🍓 El Sr. Iwatani y su equipo de desarrolladores nunca imaginaron que alguien jugaría más allá de los 256 niveles; de hecho, el juego ni siquiera fue diseñado para tener un objetivo final o una escena de victoria. Al llegar al nivel 256, no queda suficiente memoria para generar un tablero entero y tu viaje por el laberinto de PAC-MAN alcanza su final. (A menos que empieces de nuevo, por supuesto.)

## THE PESKY GHOSTS

 PAC-MAN fans are equally invested in the game's supporting characters – the four ghosts. Each has its own unique personality and even move in different ways:

## LES VILAINS FANTÔMES

 Les amateurs de PAC-MAN aiment tout autant les personnages secondaires du jeu : les quatre fantômes. Chacun a une personnalité et un comportement qui lui sont propres :

## LOS MOLESTOS FANTASMAS

 Los fans de PAC-MAN sienten un interés similar por los cuatro fantasmas, los personajes secundarios del juego. Cada uno de ellos tiene su propia personalidad e incluso se mueve de forma diferente:



### BLINKY

*BLINKY is the leader of the ghost pack, nimble and very persistent.*

*BLINKY est le chef de la bande de fantômes, agile et très tenace.*

*BLINKY es el líder de la manada de fantasmas, ágil y muy persistente.*

### INKY

*BLINKY's right-hand ghost is a little shyer than his fellow phantoms.*

*Le fantôme de confiance de BLINKY est un peu plus timide que ses camarades.*

*Mano derecha de BLINKY, es un fantasma algo más tímido que sus compañeros.*



### CLYDE

*Quite the explorer, CLYDE constantly wanders into every corner he can find.*

*Grand explorateur, CLYDE déambule constamment dans tous les coins qu'il peut trouver.*

*Como buen explorador, CLYDE se adentra constantemente en todos los rincones que encuentra.*

### PINKY

*Don't let PINKY's delicate looks fool you – she is a lethal opponent!*

*Ne laissez pas l'apparence délicate de PINKY vous tromper : elle est une redoutable adversaire !*

*No dejes que la delicada apariencia de PINKY te engañe: ¡es una enemiga mortal!*



## PAC-MAN PERSISTS

 The unpretentious protagonist and playful adversaries have evolved in countless iterations over the decades. Still, the nostalgia of the original arcade game remains unrivaled, and PAC-MAN remains universally relatable, timeless and infinitely adaptable to new technologies.

## PAC-MAN PERDURE

 Le protagoniste sans prétention et ses adversaires espiègles ont connu d'innombrables itérations au fil des décennies. Pourtant, le charme du jeu d'arcade d'origine demeure inégalé, et PAC-MAN reste universellement attachant, intemporel et infiniment adaptable aux nouvelles technologies.

## PAC-MAN PERSISTE

 El modesto protagonista y sus juguetones adversarios han evolucionado en innumerables ocasiones a lo largo de las décadas. Sin embargo, la incomparable nostalgia del juego de arcade original se mantiene imbatible, y PAC-MAN sigue siendo universalmente identificable, atemporal e infinitamente adaptable a las nuevas tecnologías.







SVEN FRANIC  
LEGO® Icons Model Designer  
Concepteur de modèles LEGO® Icons  
Modelista de LEGO® Icons



## BEAUTY THROUGH SIMPLICITY

🍒 "Each generation of fans has fond memories of their 'own' version of PAC-MAN. I clearly remember the classic arcade game halls! Inspired by the original arcade version from 1980, we collaborated with Bandai Namco Entertainment Inc. to create this set. The game mechanics, color scheme and pixelated graphics are a perfect fit for a LEGO® Icons set. We wanted to capture the nostalgic gaming experience by simulating different functions: Turn on a light by pressing the button by the coin slot, move the joystick and crank the lever on the side to move the characters through the maze. Black elements camouflage the mechanics, and a newly developed link element on the chain allows the icons to turn the sharp corners. We hope it brings back all your favorite memories, too."

## LA BEAUTÉ DANS LA SIMPLICITÉ

🍌 « Chaque génération d'amateurs conserve de bons souvenirs de sa "propre" version de PAC-MAN. Je me souviens clairement des salles de jeu d'arcade classiques ! Inspirés par la version originale d'arcade de 1980, nous avons collaboré avec Bandai Namco Entertainment Inc. pour créer cet ensemble. La mécanique du jeu, le schéma de couleurs et les graphiques pixellisés conviennent parfaitement à un ensemble LEGO® Icons. Nous voulions reproduire l'expérience nostalgique du jeu en simulant différentes fonctions : allumer une lumière en appuyant sur le bouton près de la fente à monnaie, utiliser le manche à balai et le levier sur le côté pour déplacer les personnages dans le labyrinthe. Des éléments noirs camouflent la mécanique, et un élément de liaison nouvellement développé sur la chaîne permet aux icônes de négocier les angles aigus. Nous espérons qu'il vous rappellera à vous aussi tous vos souvenirs préférés. »

## LA BELLEZA A TRAVÉS DE LA SENCILLEZ

🍓 "Cada generación de fans tiene buenos recuerdos de su "propia" versión de PAC-MAN. ¡Recuerdo claramente las clásicas salas de arcade! Inspirado en la versión original de arcade de 1980, en colaboración con Bandai Namco Entertainment Inc., hemos creado este set. La mecánica del juego, la combinación de colores y los gráficos pixelados encajan perfectamente en un set LEGO® Icons. Queríamos capturar la experiencia nostálgica del juego simulando diferentes funciones: enciende una luz presionando el botón que hay junto a la ranura para las monedas, usa el *joystick* y gira la manivela que hay a un lado para que los personajes se muevan por el laberinto. Los elementos en negro camuflan la mecánica, y un nuevo elemento de enlace en la cadena permite que los íconos rodeen las esquinas. Esperamos que también evoque todos tus recuerdos favoritos".

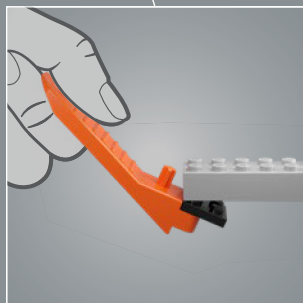
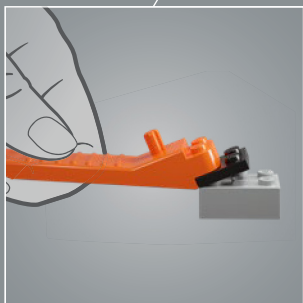
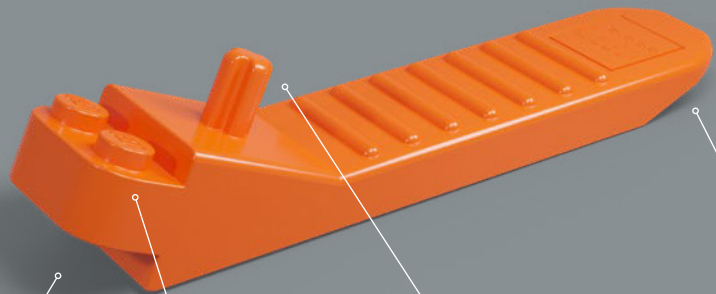

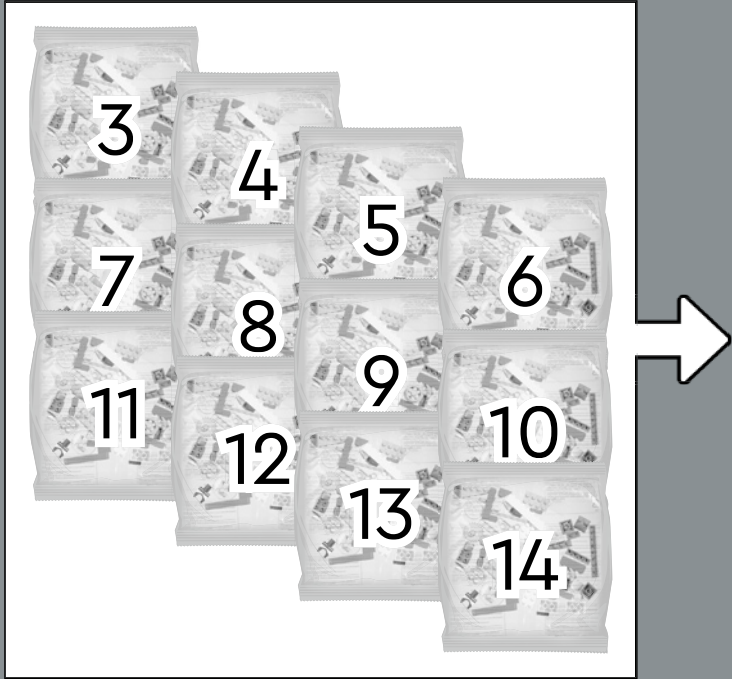
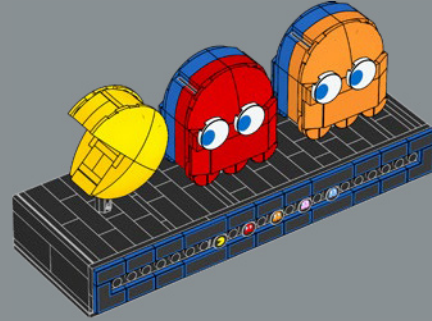

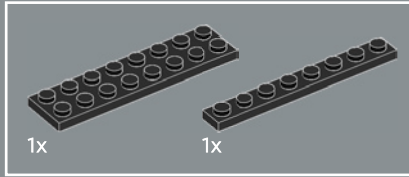
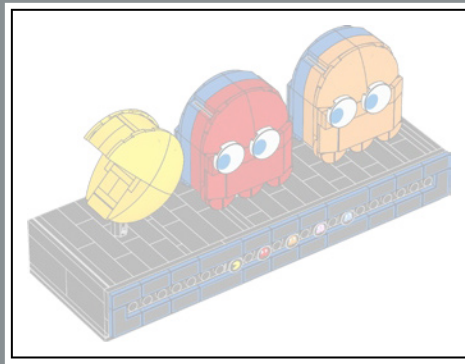

1

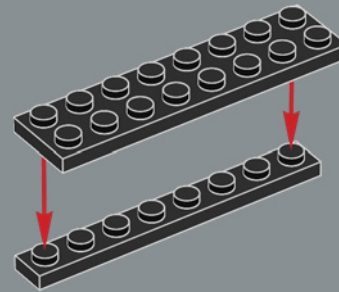



2

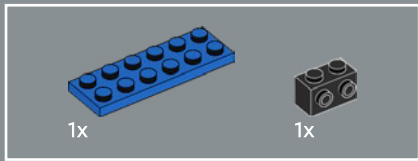
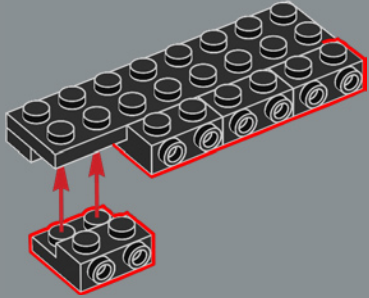

3

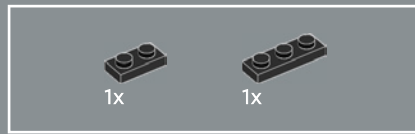
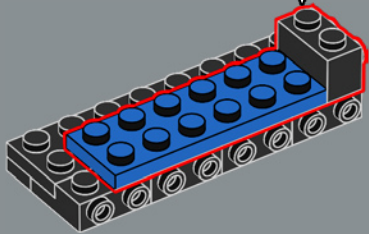
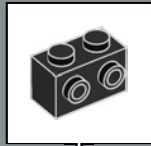

4

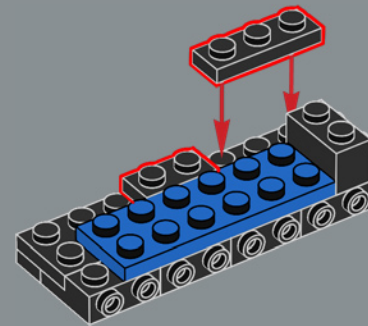

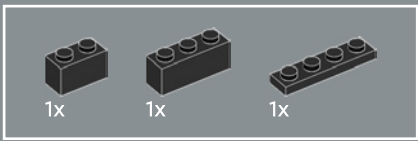

5

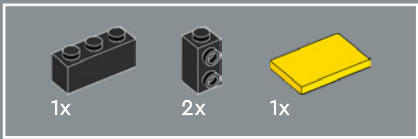
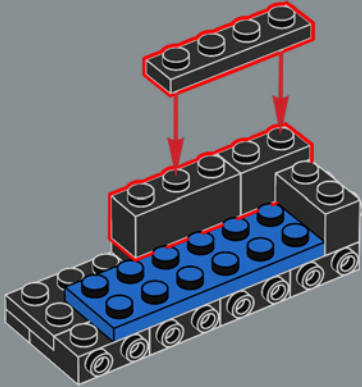

6

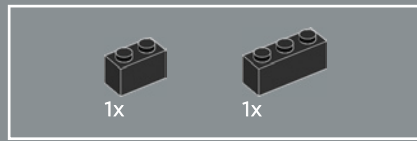
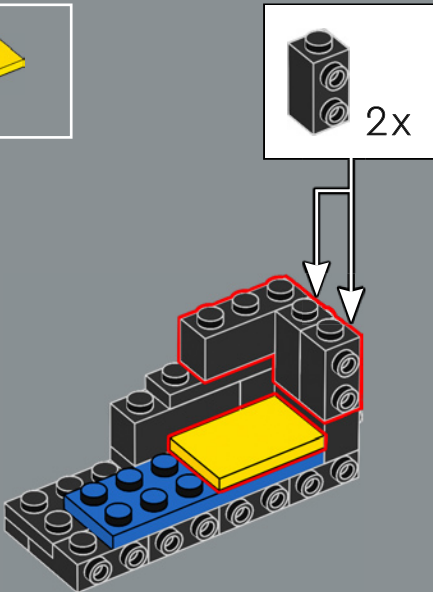

7

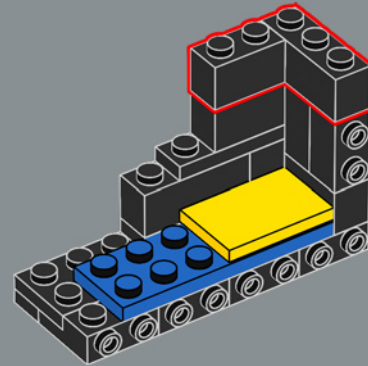

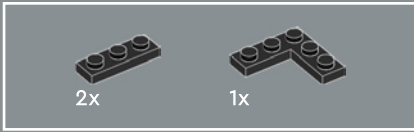
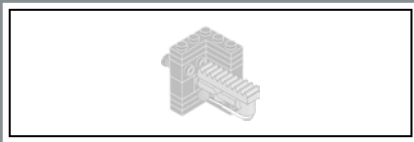

8

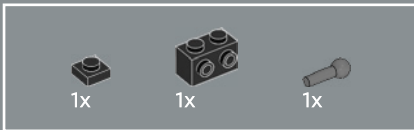
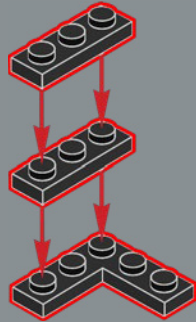

9

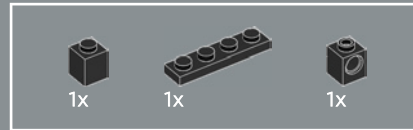
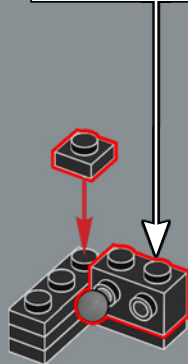
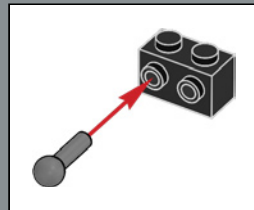

10

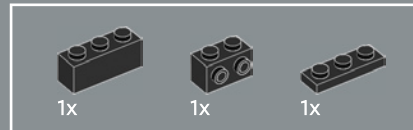
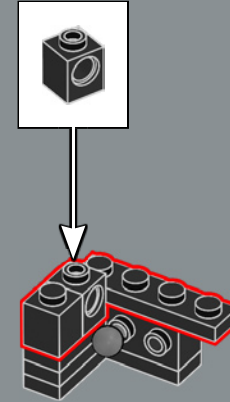

11

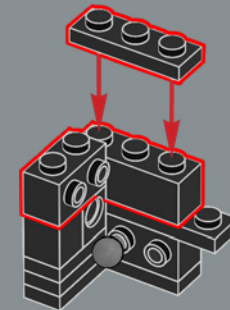

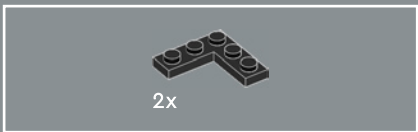

12

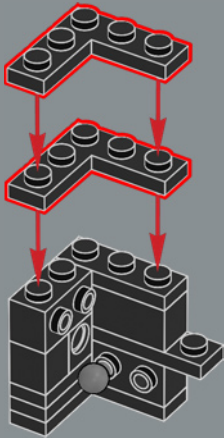

13

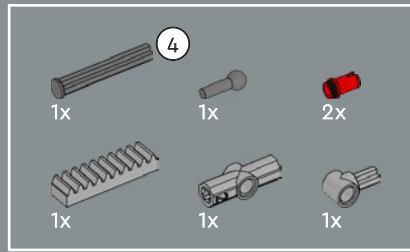
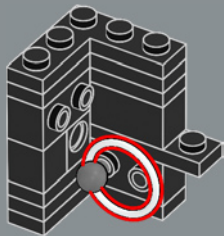

14

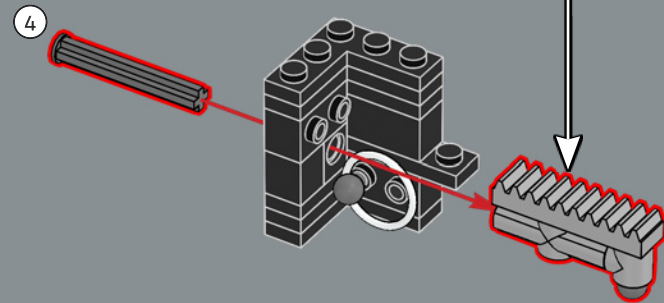
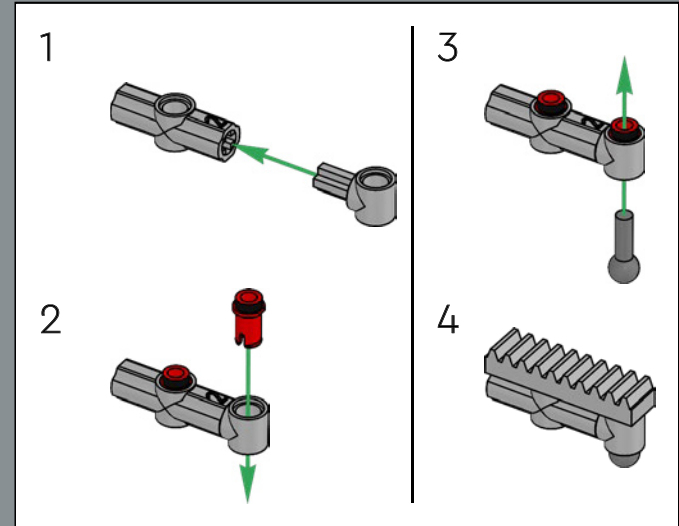



15

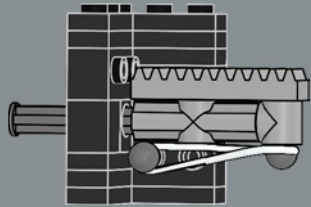

16

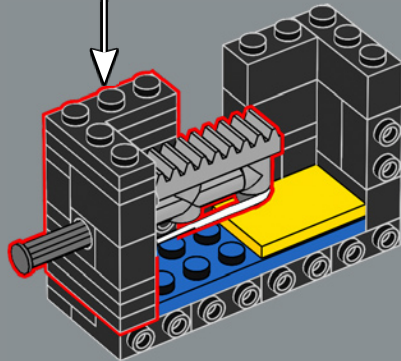

3x



1x

17

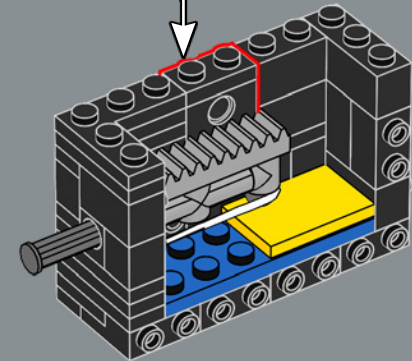
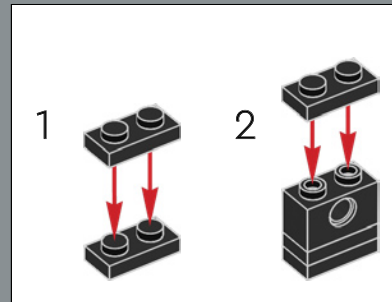

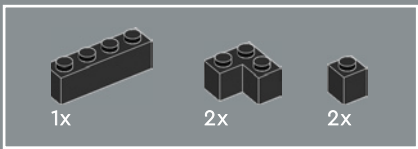

18

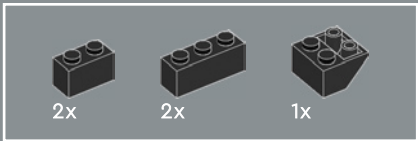
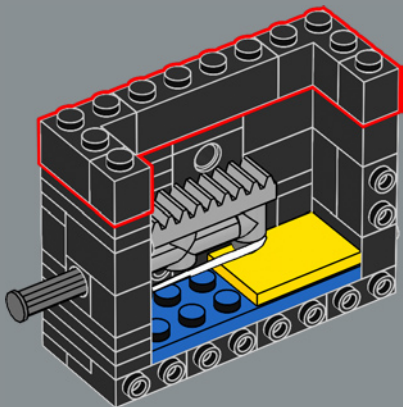

19

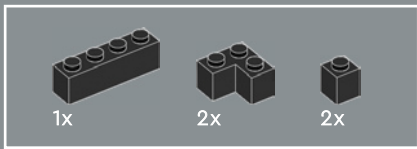
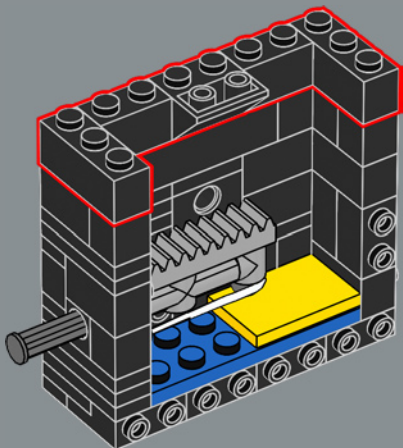

20

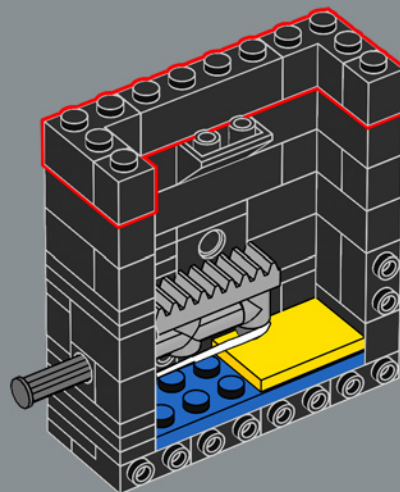

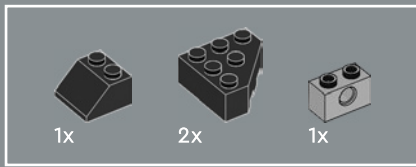

21

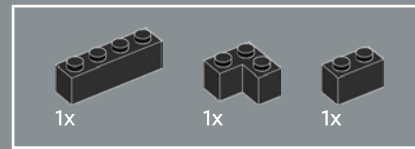
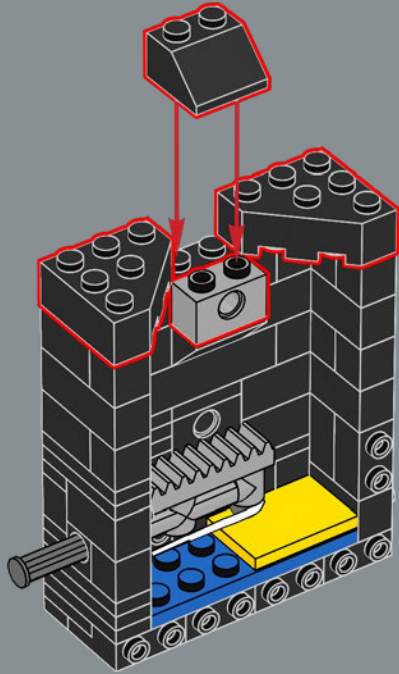

22

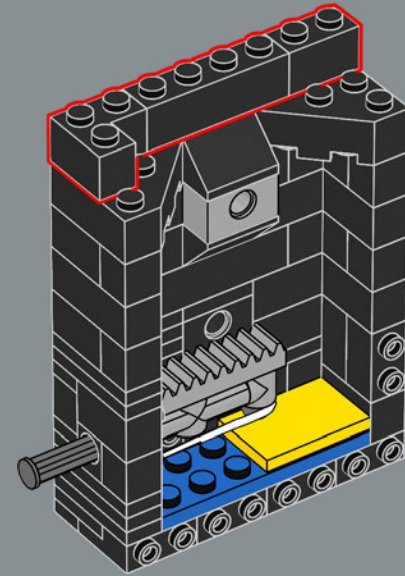

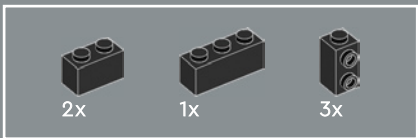

23

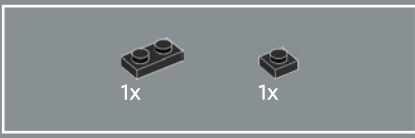
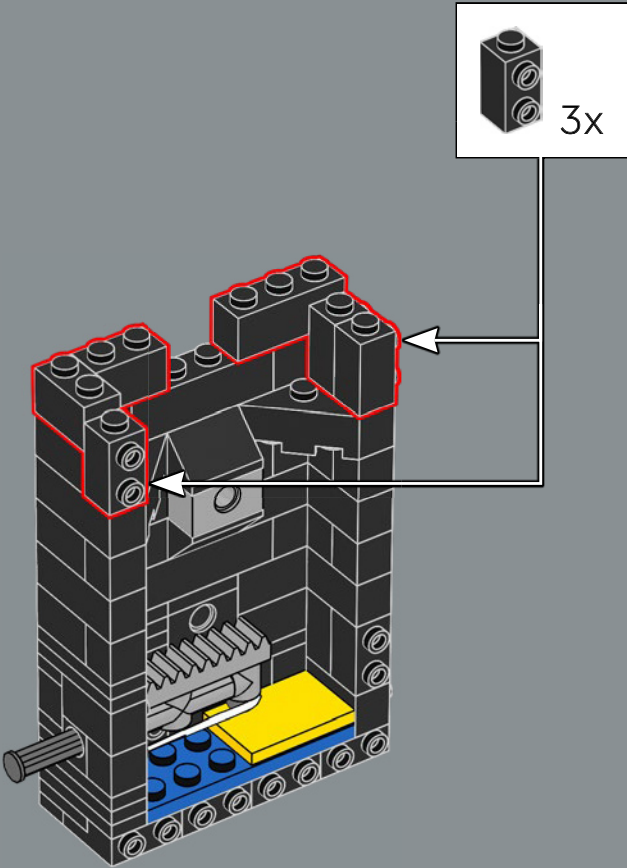

24

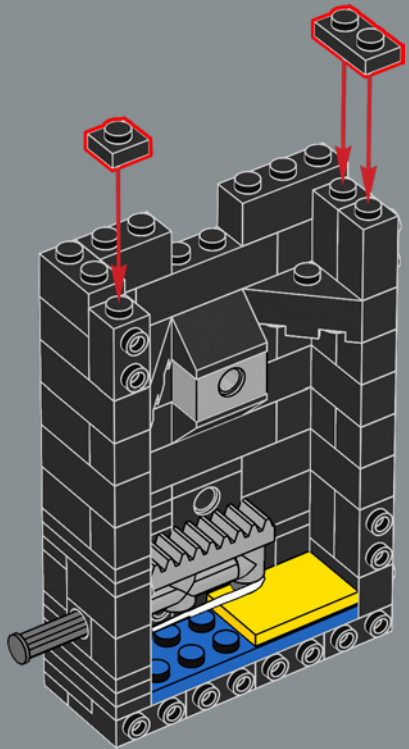

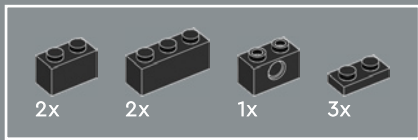

25

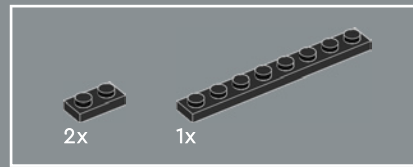
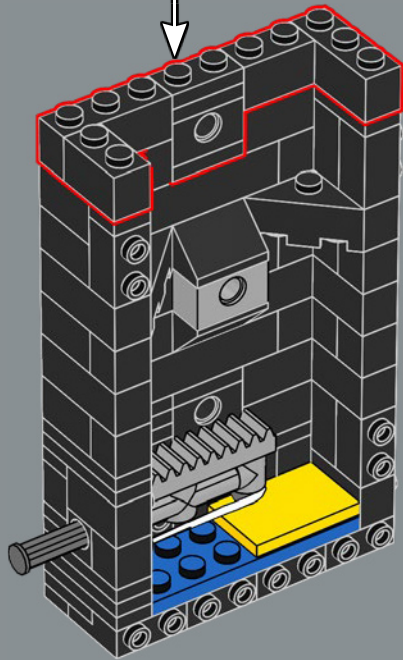
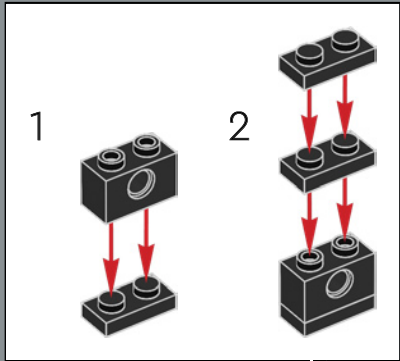

26

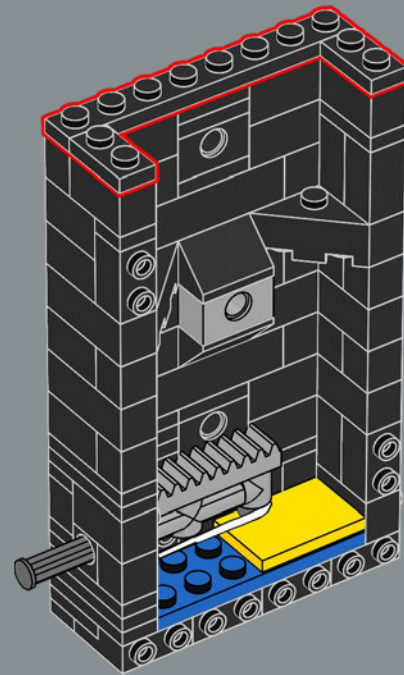

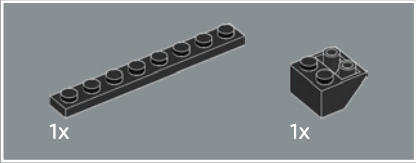
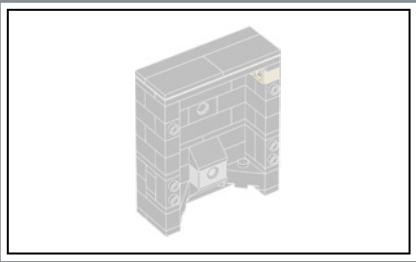

27

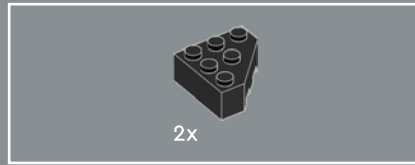
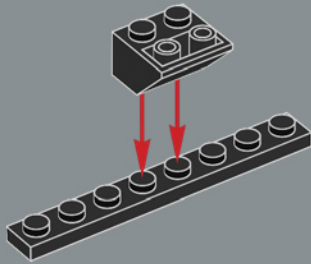

28

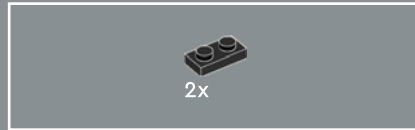
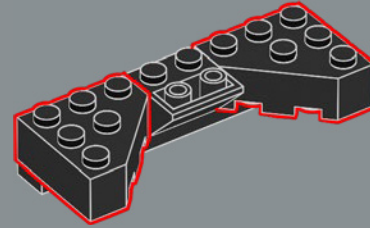

29

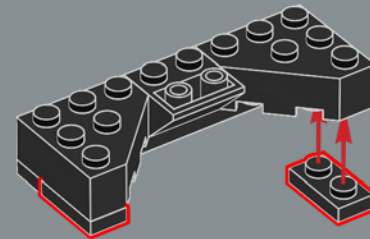

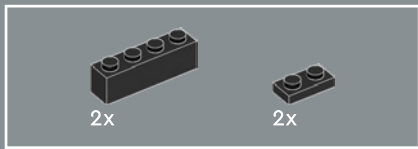

30

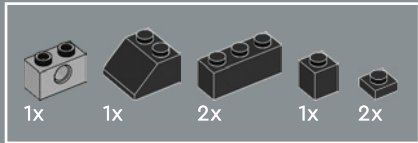
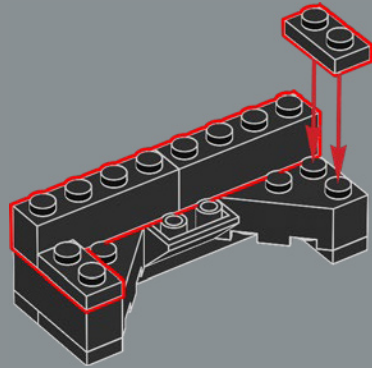

31

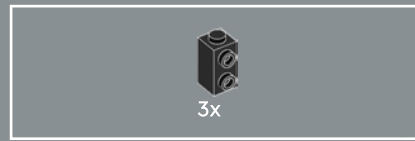
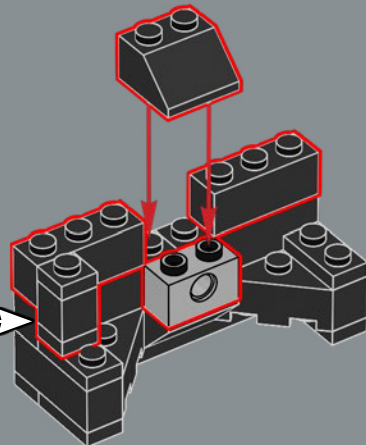
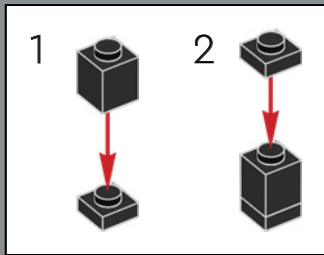

32

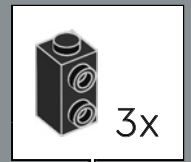
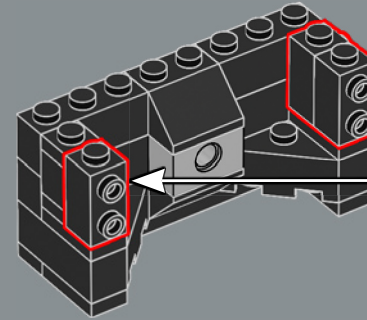

33

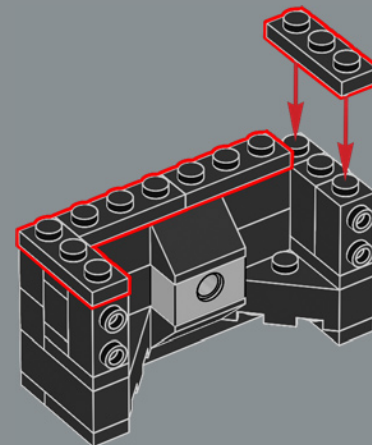
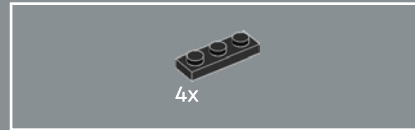

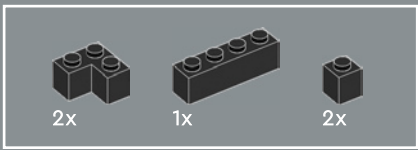

34

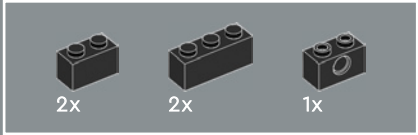
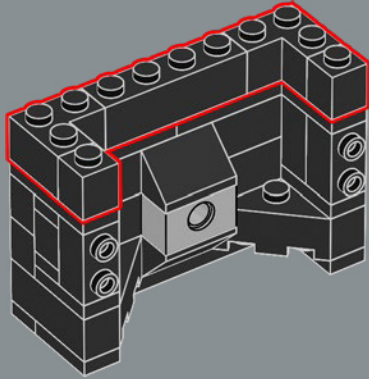

35

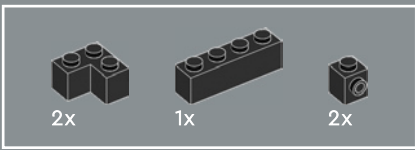
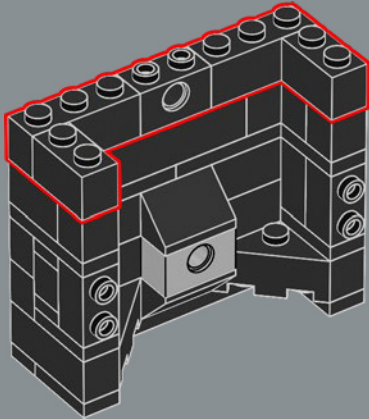

36

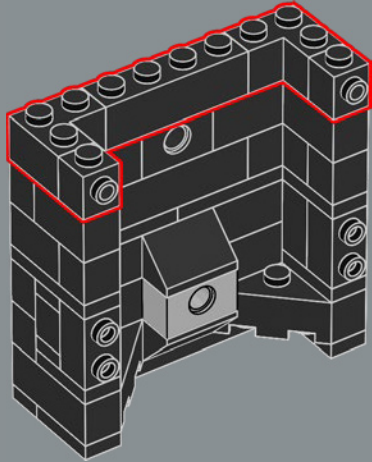



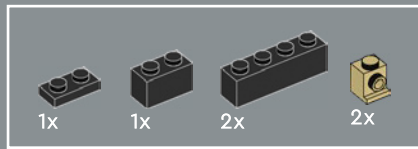

37

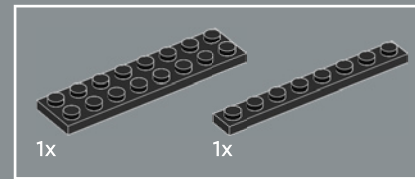
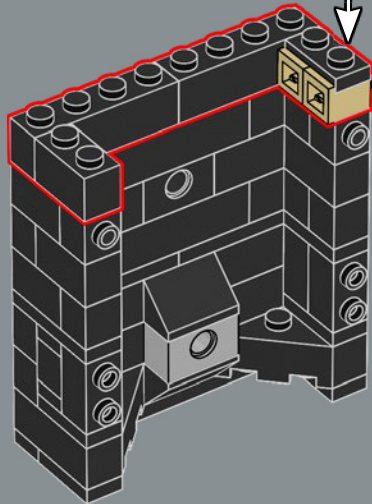
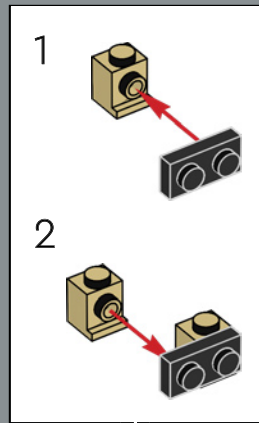

38

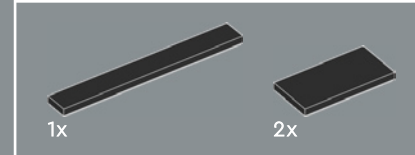
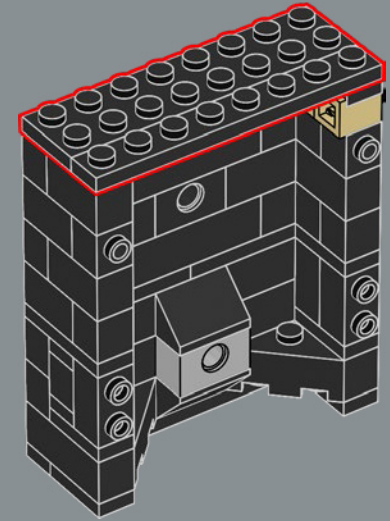

39

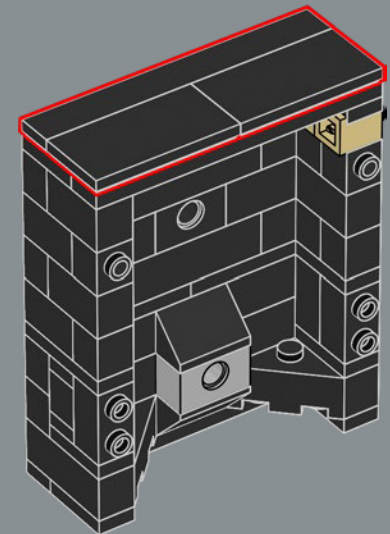

40



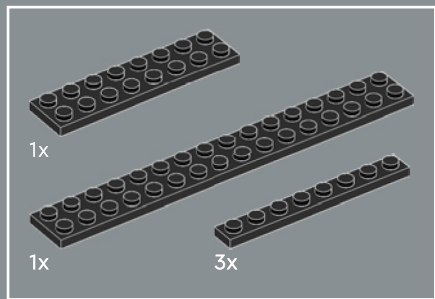

41

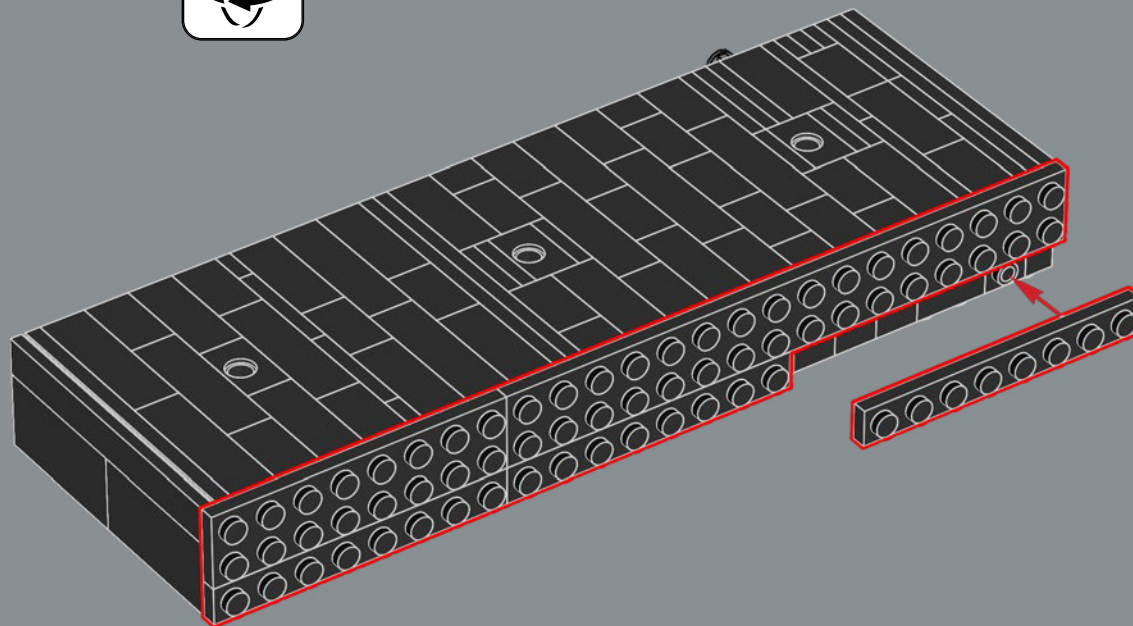

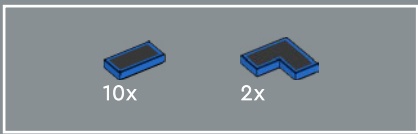

42

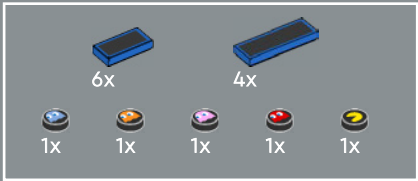
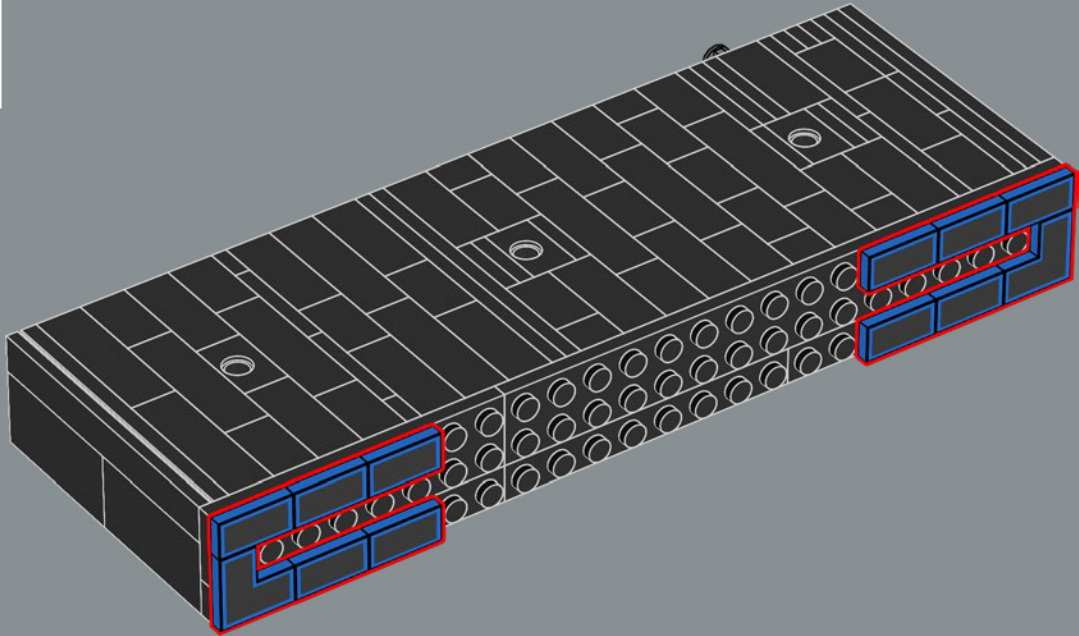

43

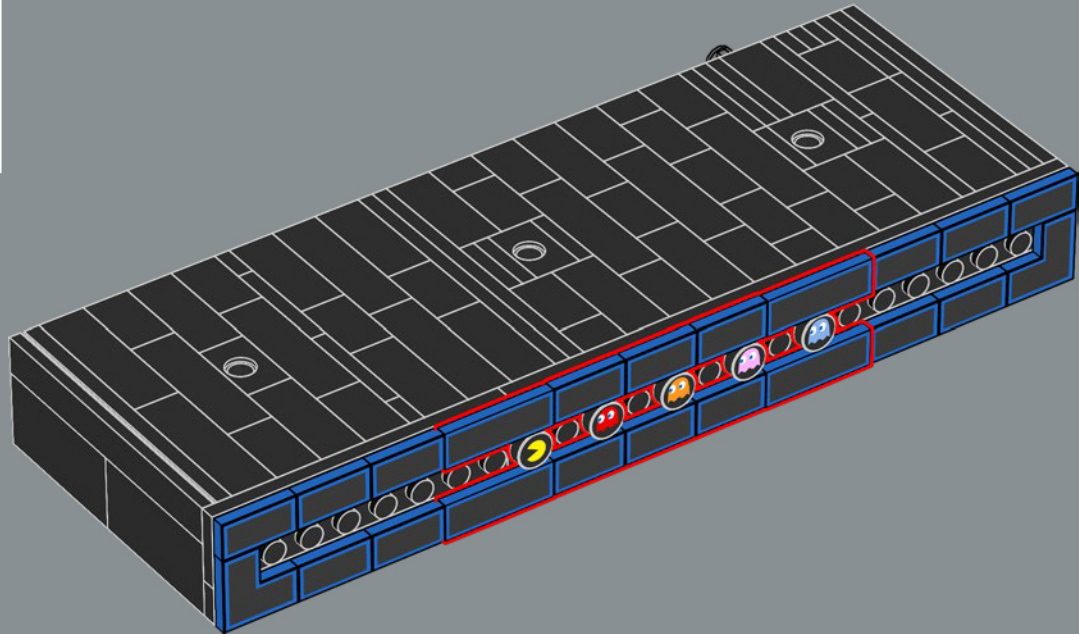



44

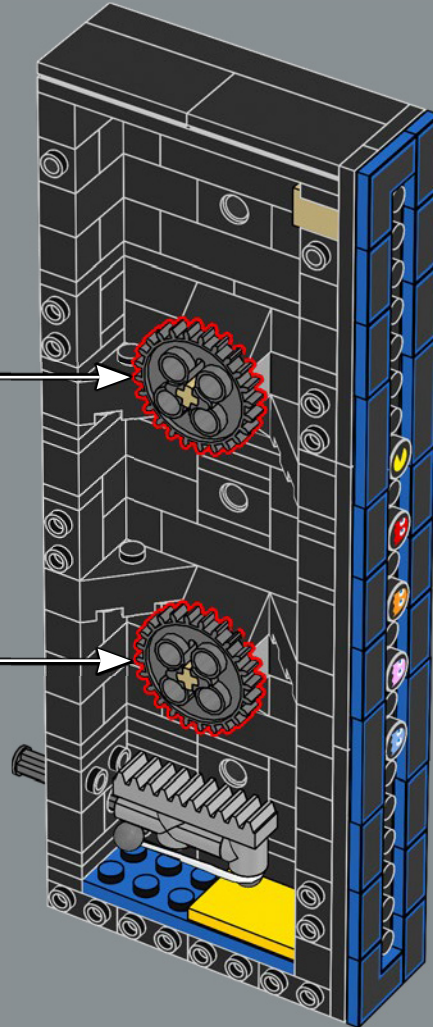
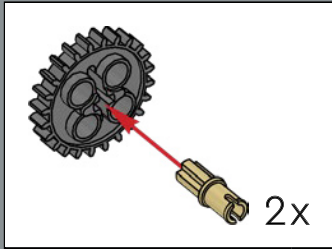

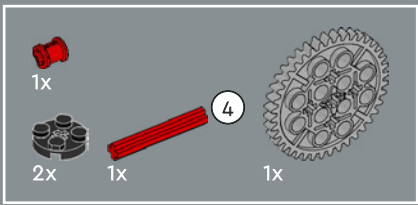

45

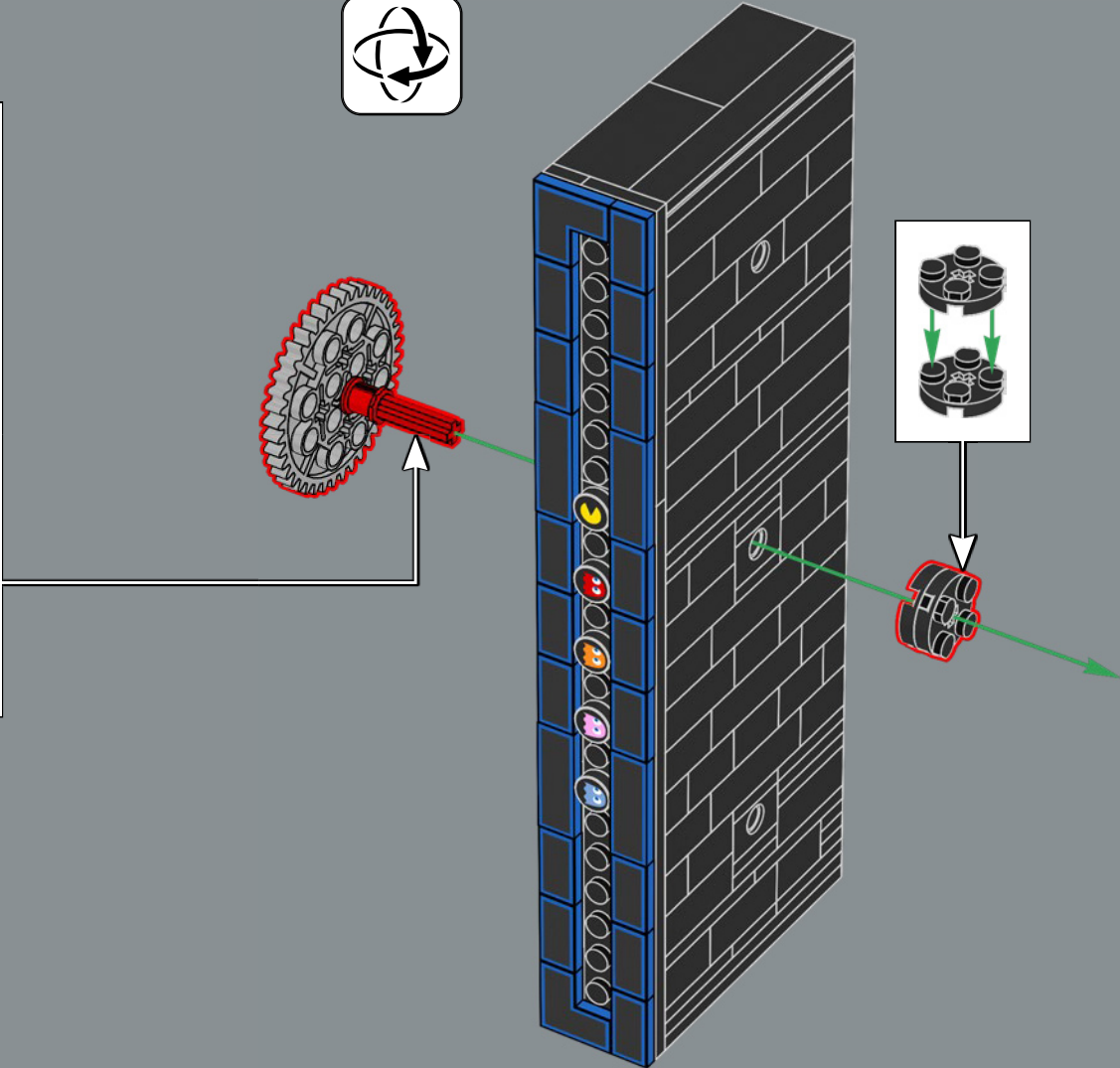
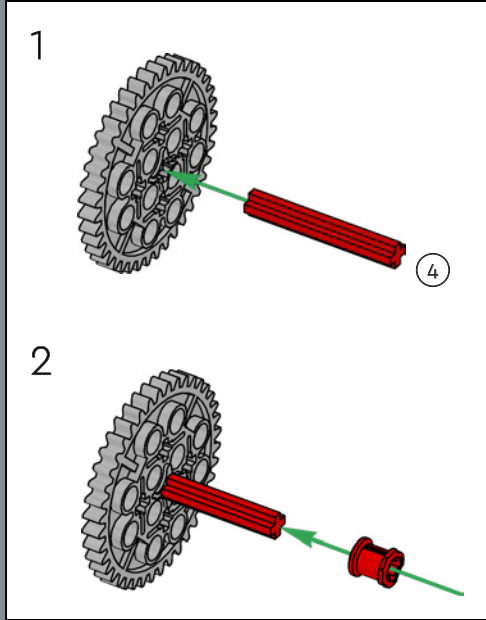

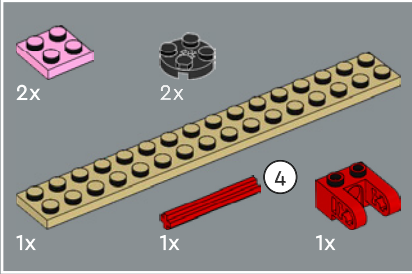
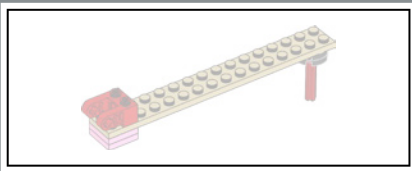

46

1

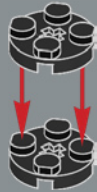

2

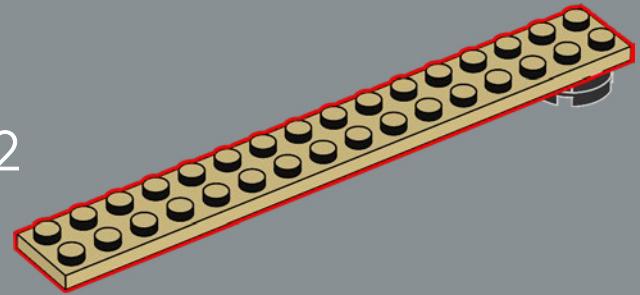

3

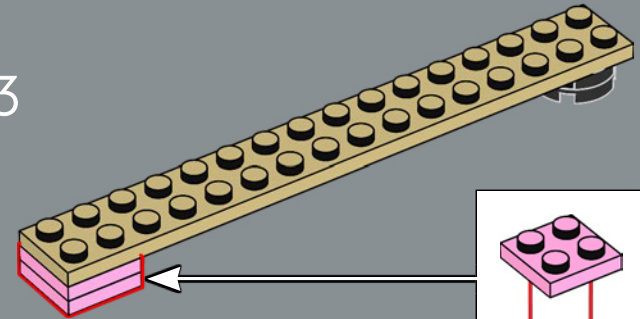

4

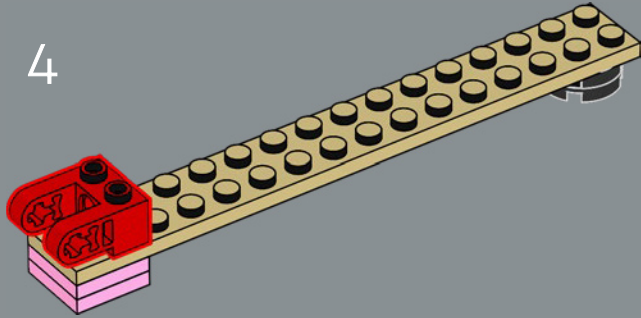

5

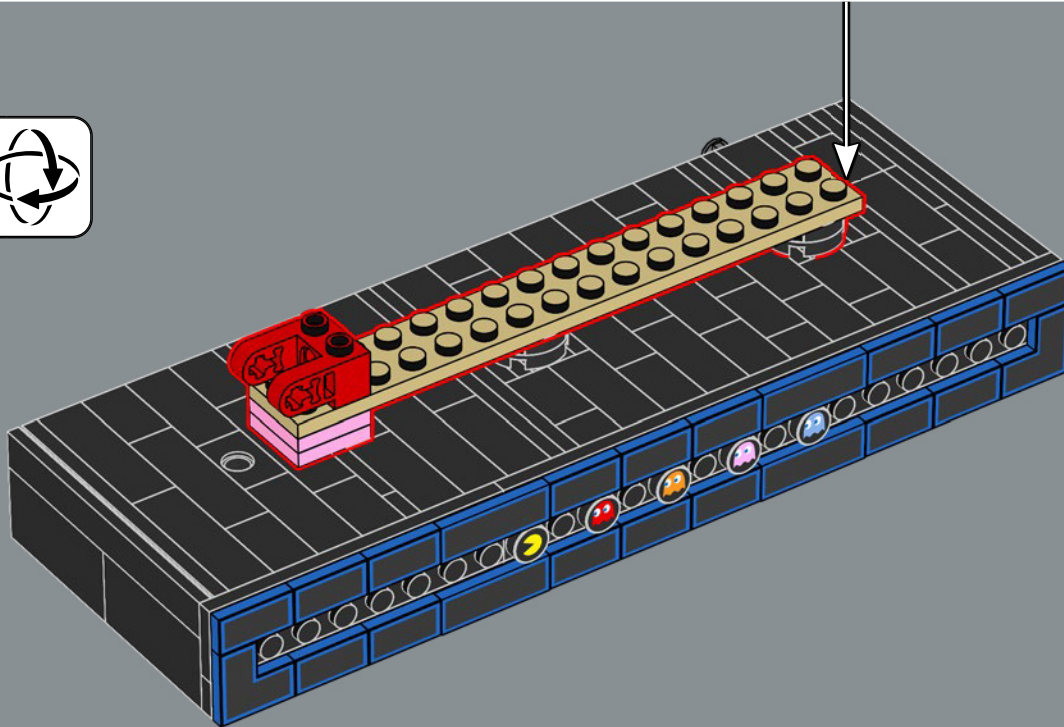
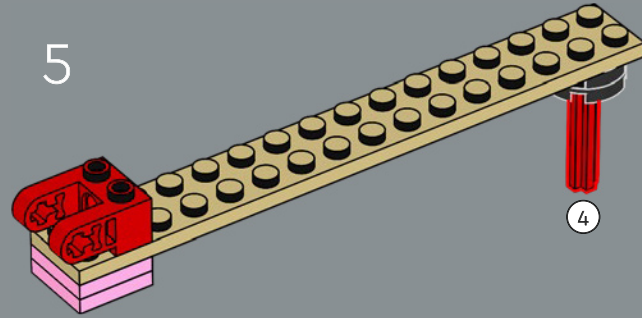



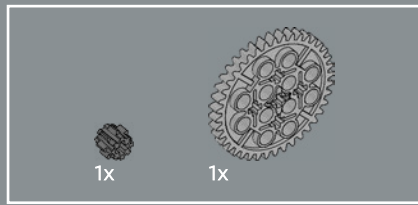

47

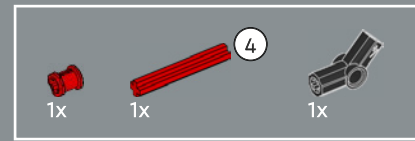
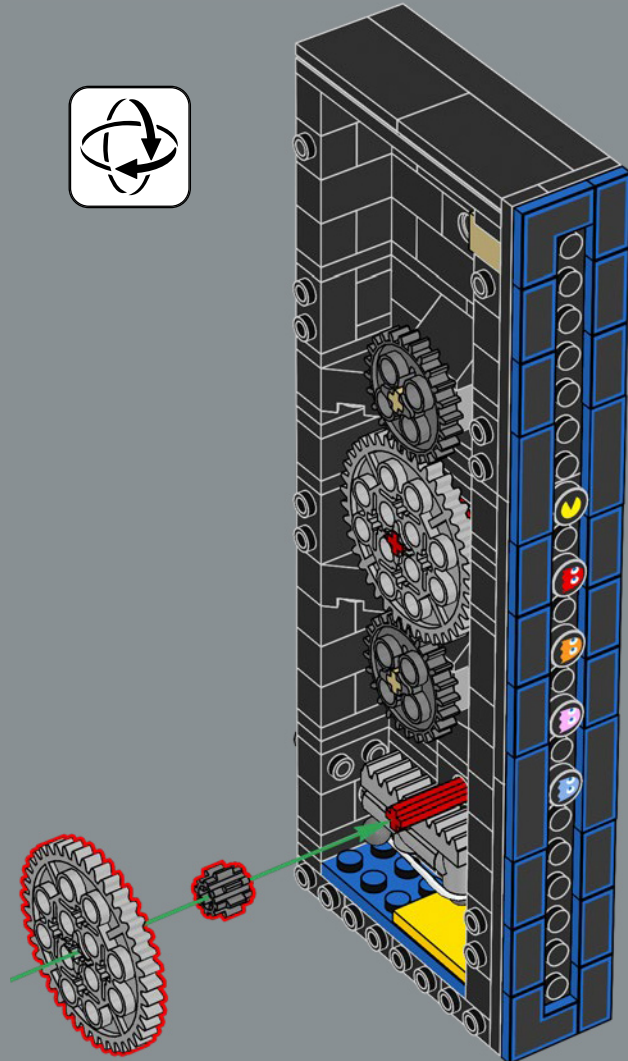

48

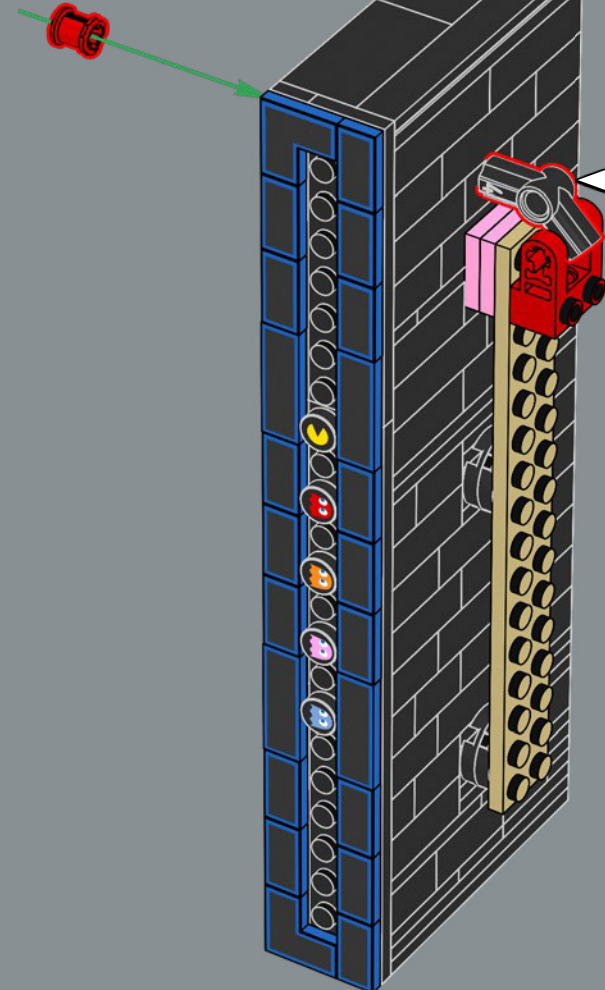
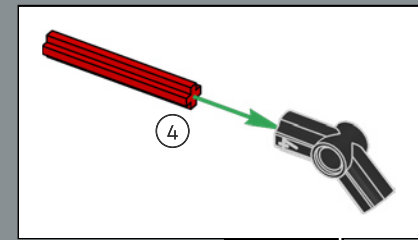

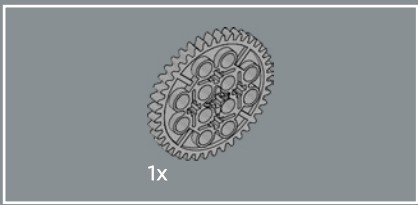

49

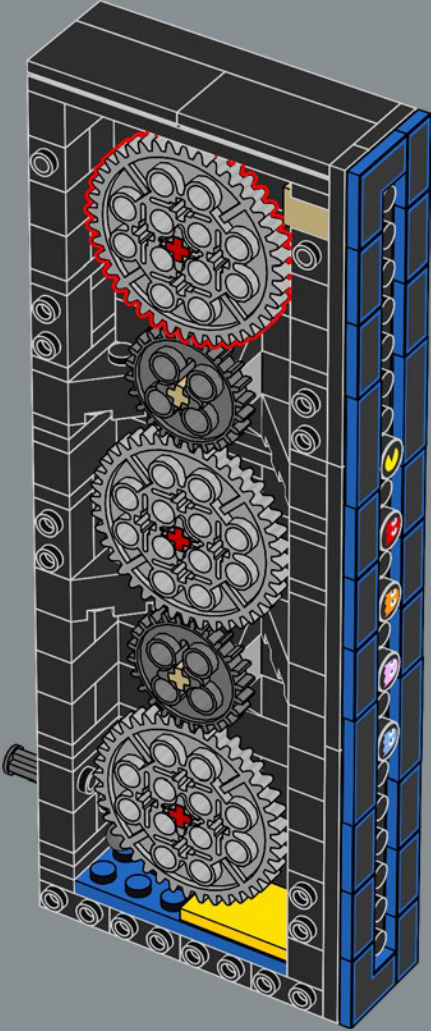

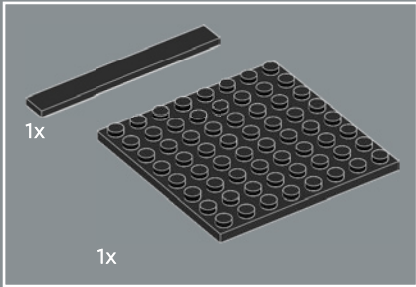
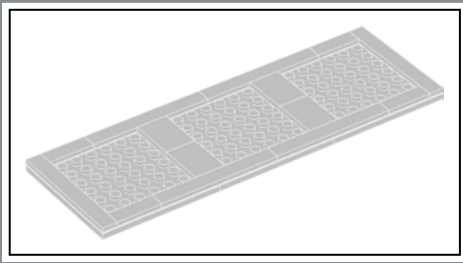

50

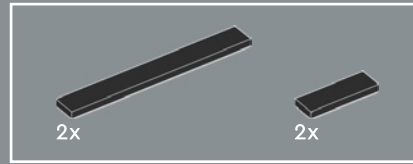
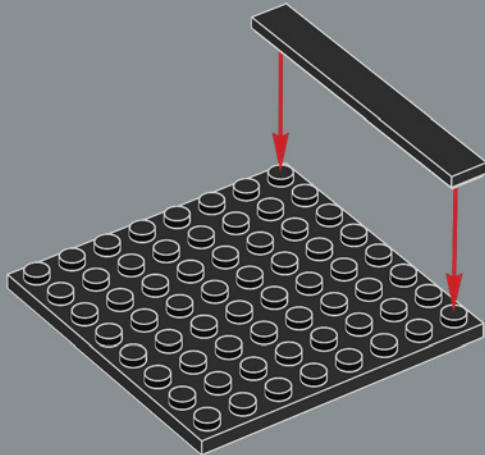

51

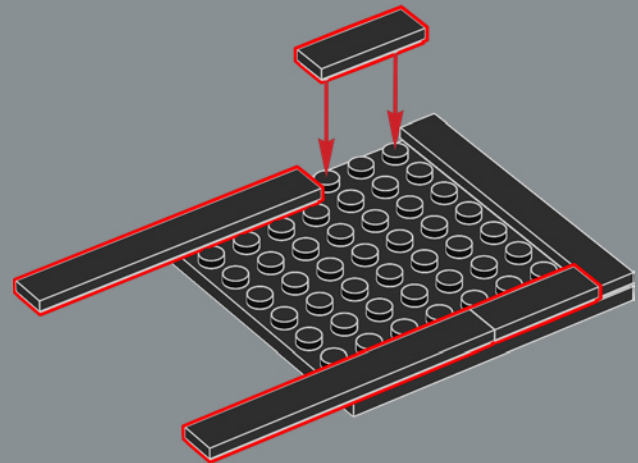

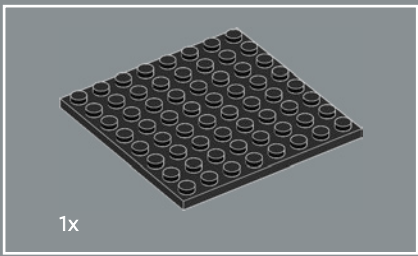

52

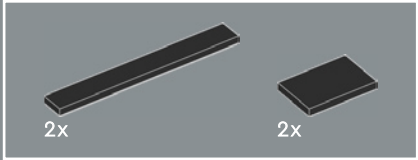
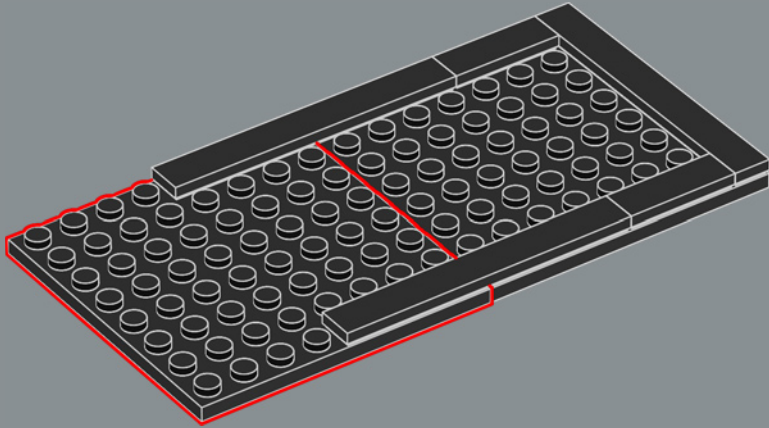

53

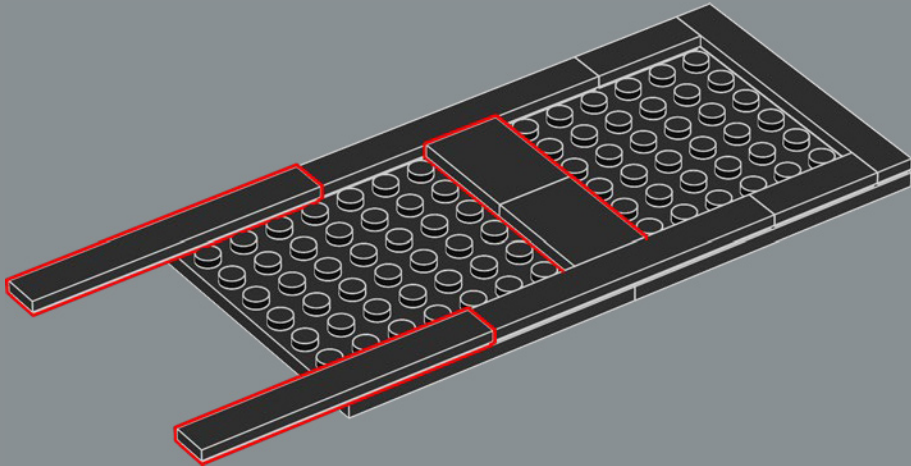

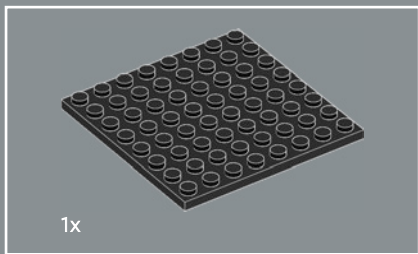

54

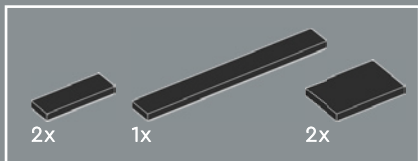
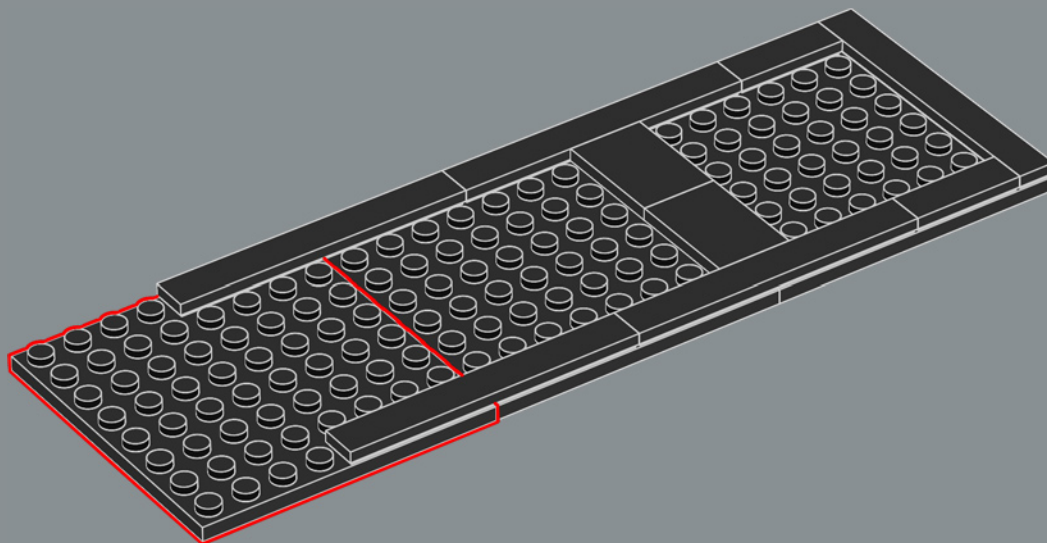

55

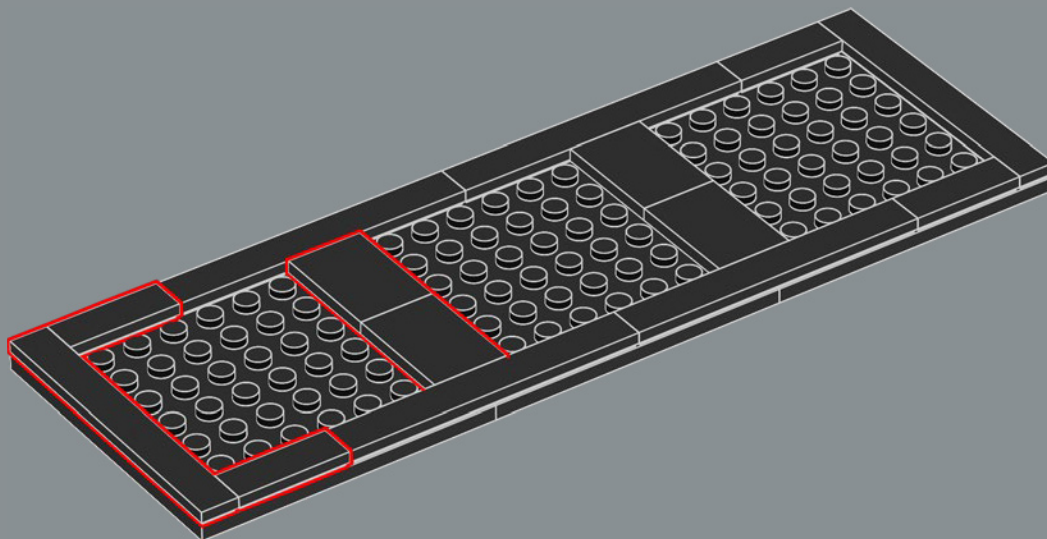

56

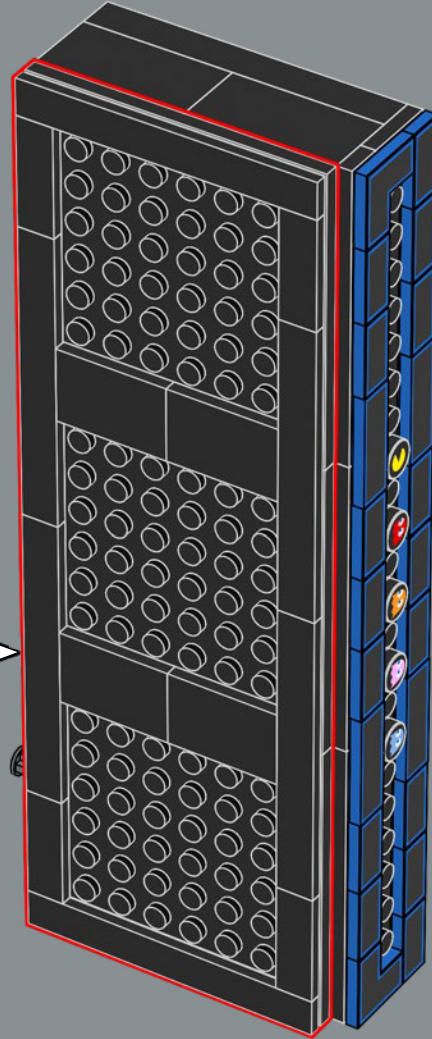

57



1

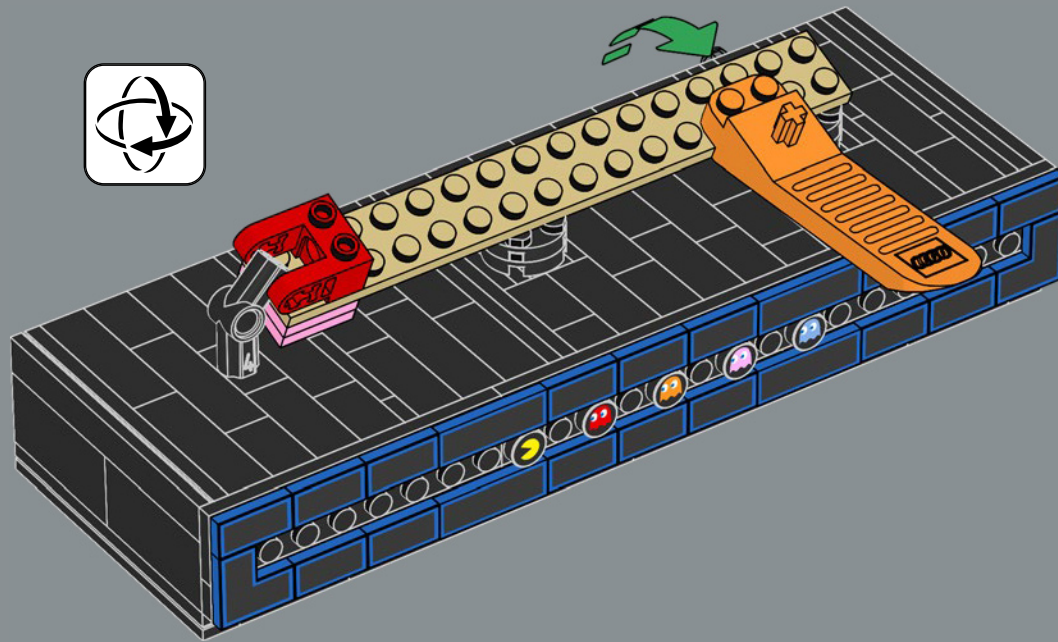

2

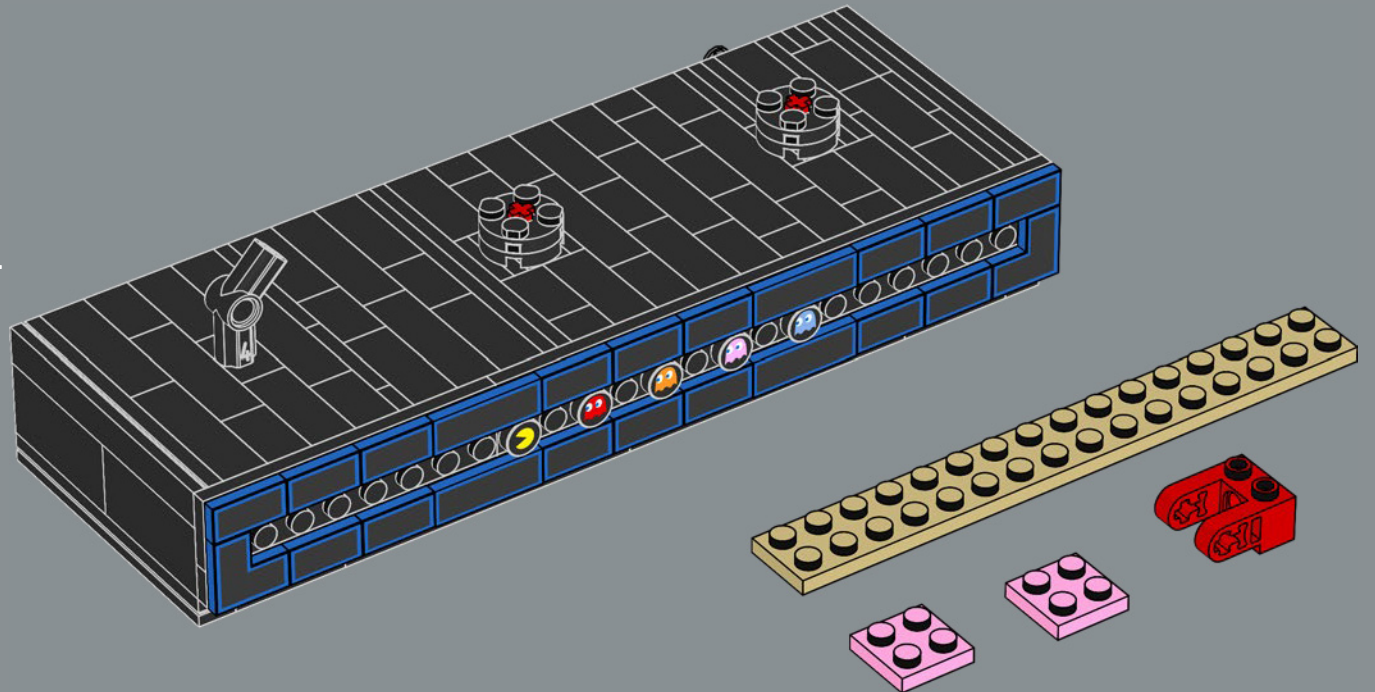

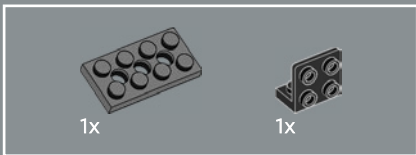
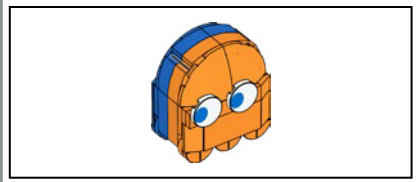

58

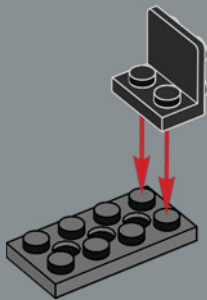

59

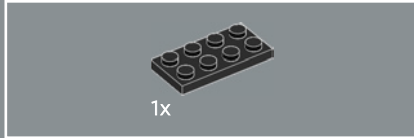
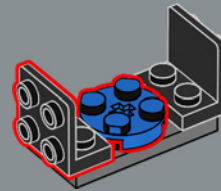

60

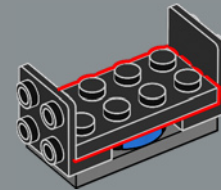



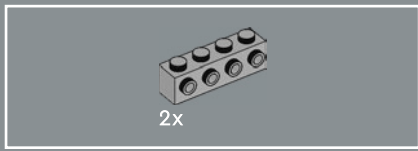

61

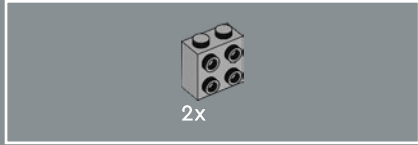
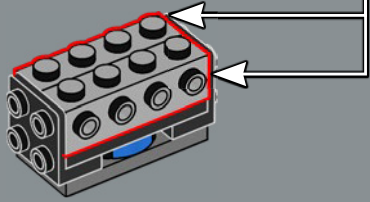
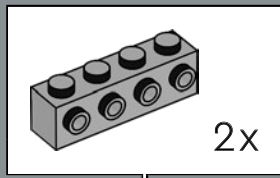

62

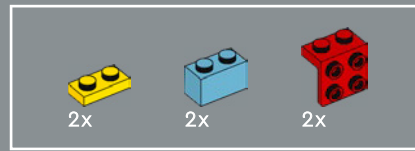
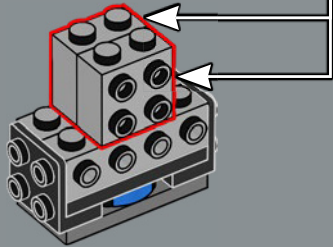
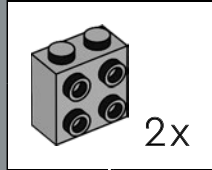

63

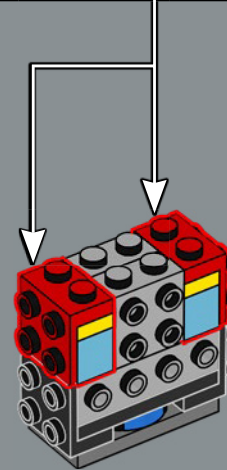
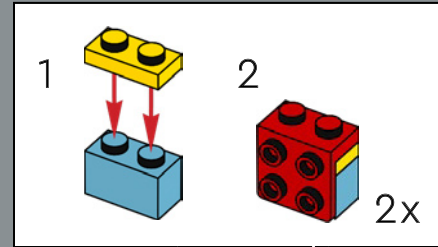



2x

64

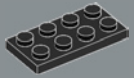
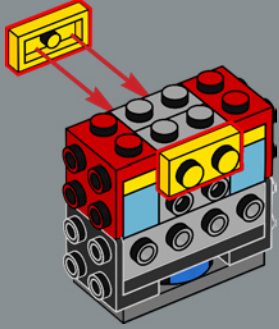

2x



1x

65

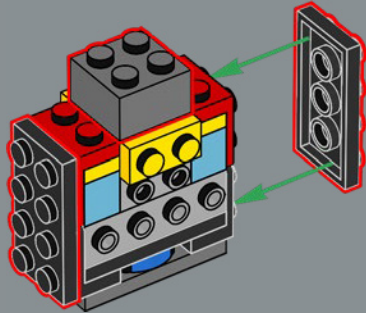

2x



1x



2x

66

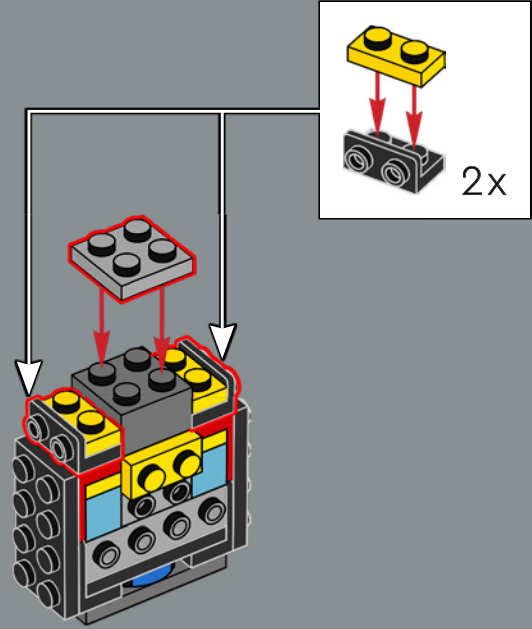



67

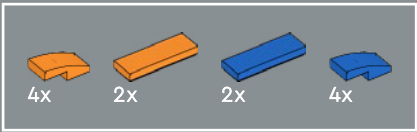
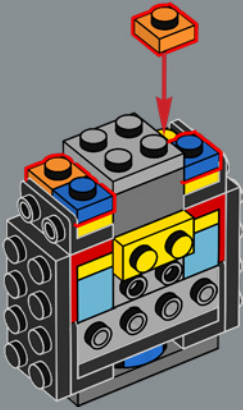

68

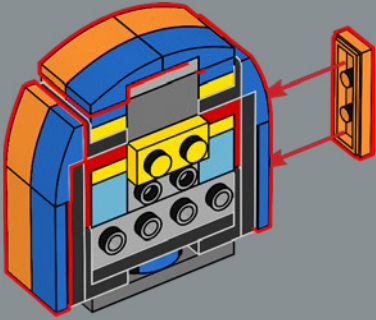

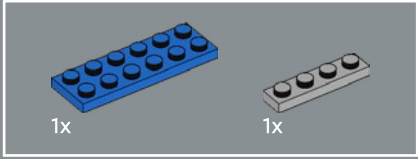
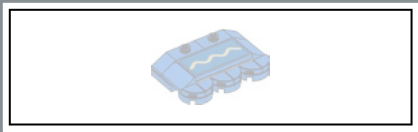

69

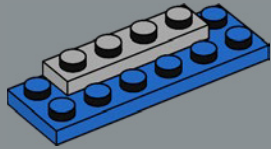

70

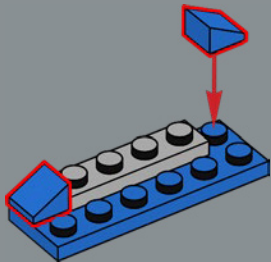

71

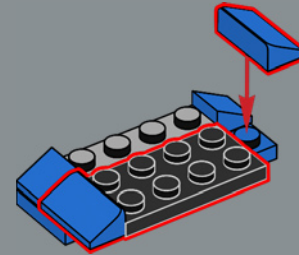

72

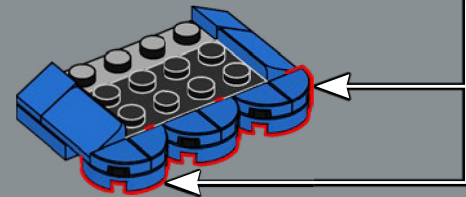
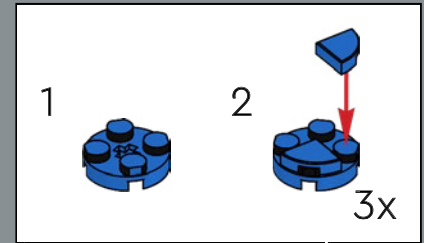

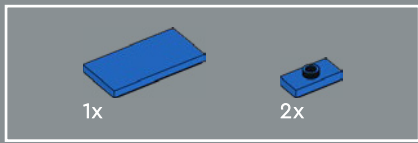

73

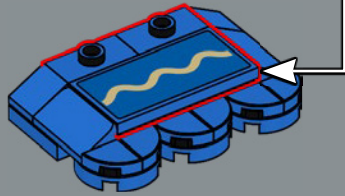
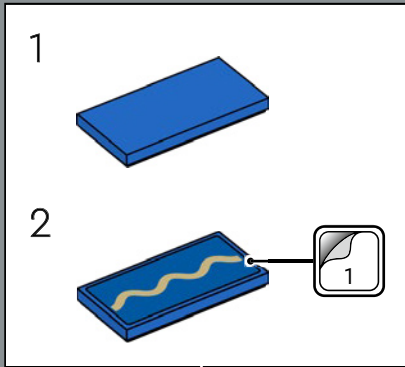

74

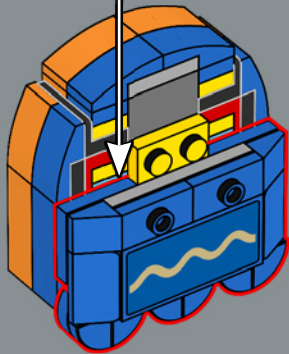

75

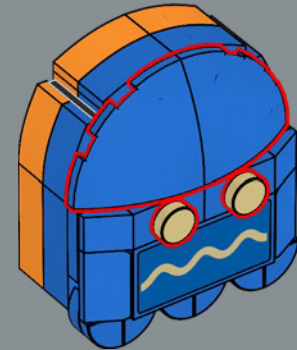

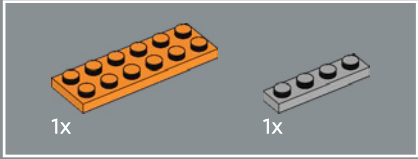
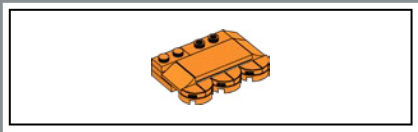

76

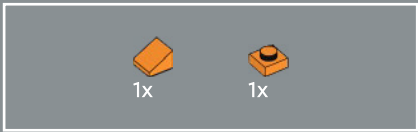
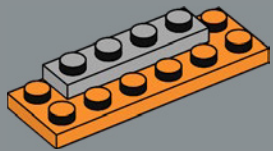

77

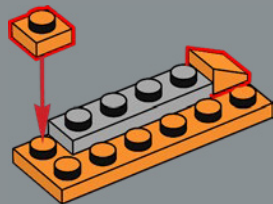

78

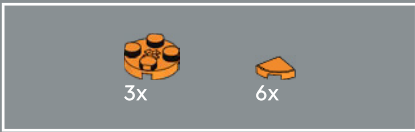
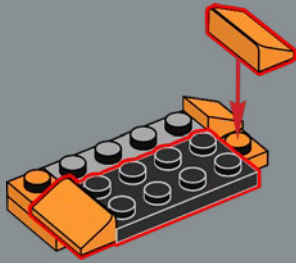

79

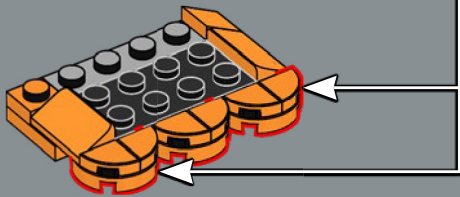
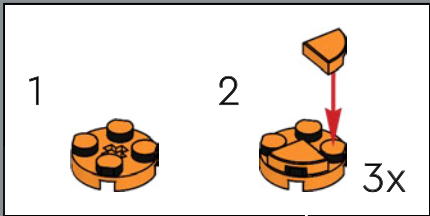



80

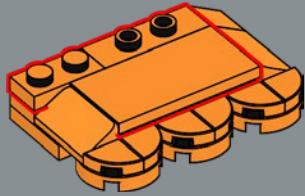

81



82

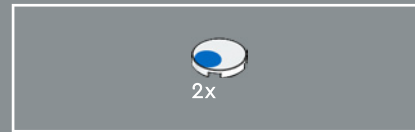
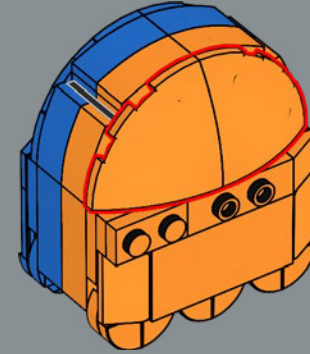

83

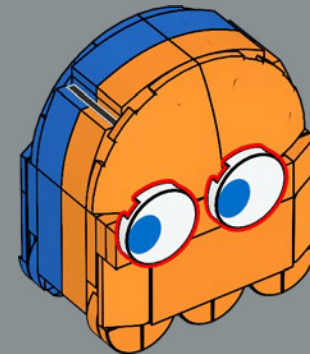



Fans have a strong affinity for the ghosts, too, and we wanted to bring out their personalities in larger, brick-built versions.

Les amateurs adorent également les fantômes, et nous voulions faire ressortir leur personnalité dans des versions plus grandes en briques.

A los fans también les gustan los fantasmas, y queríamos resaltar sus personalidades en versiones a gran escala para construir con bricks.

84

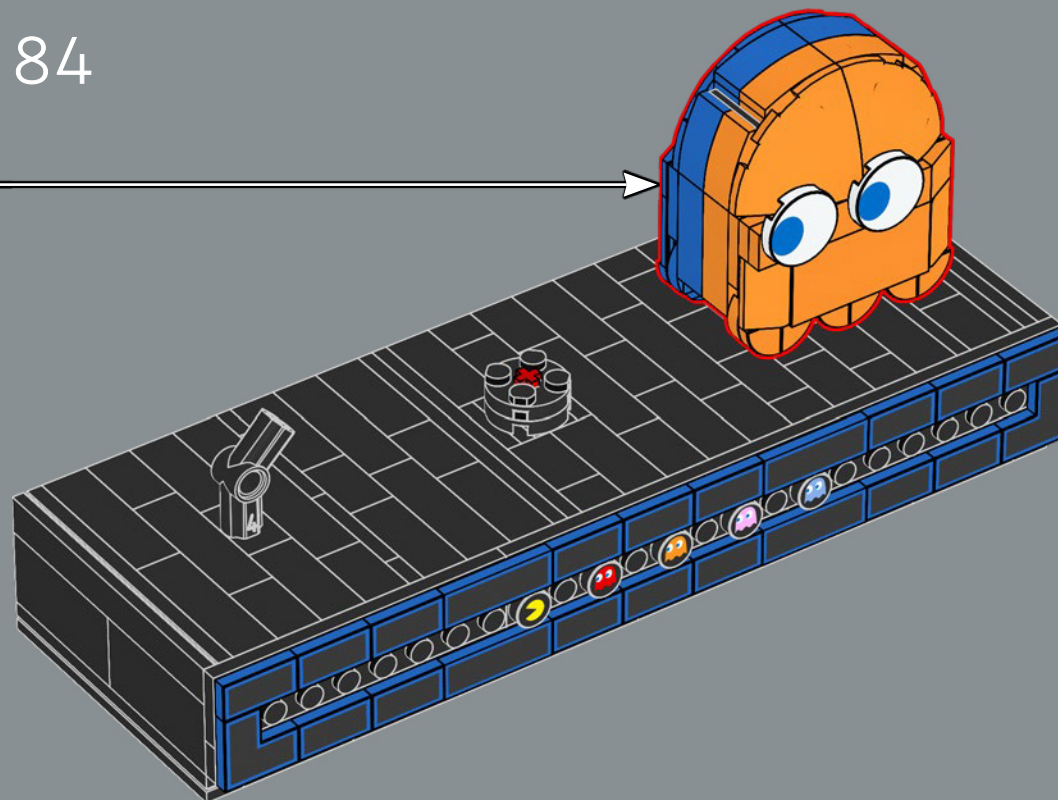



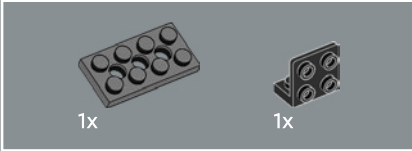
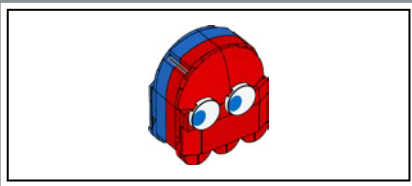

85

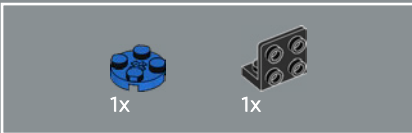
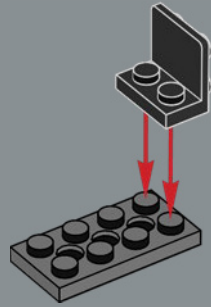

86

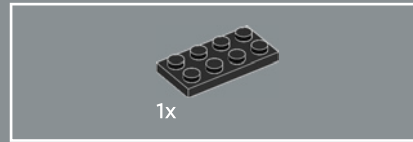
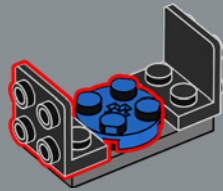

87

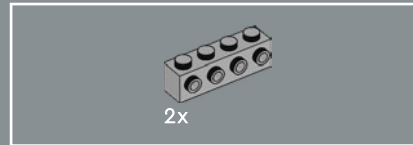
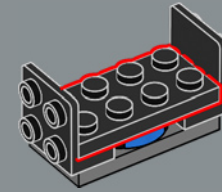

88

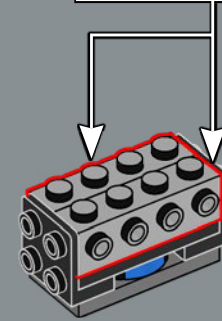
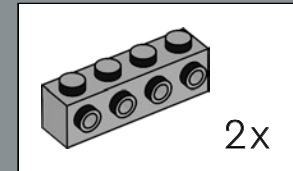



2x

89

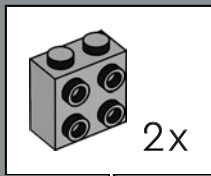

2x

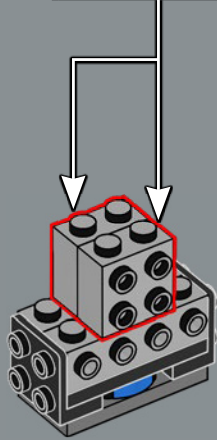

2x



2x



2x

90

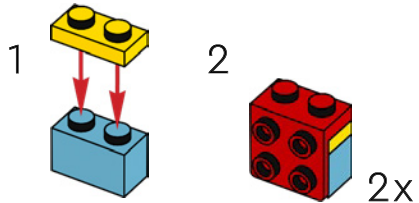

1

2

2x

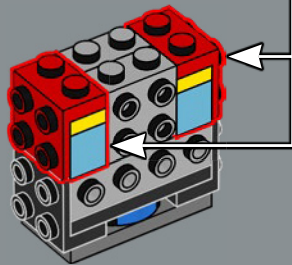

2x

91

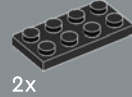
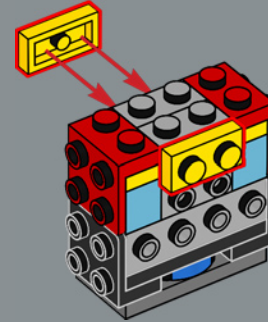

2x

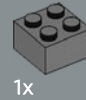

1x

92

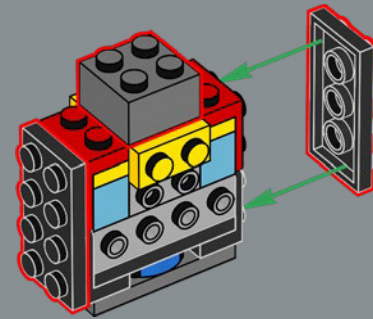

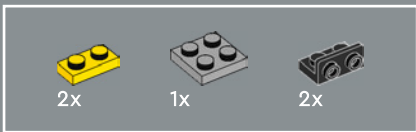

93

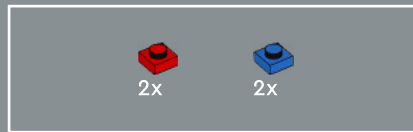
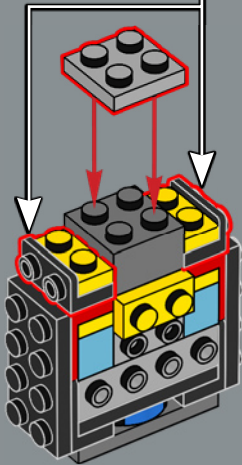
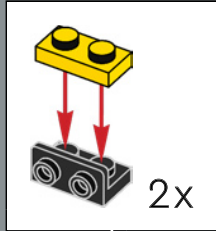

94

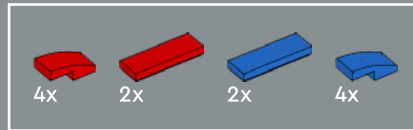
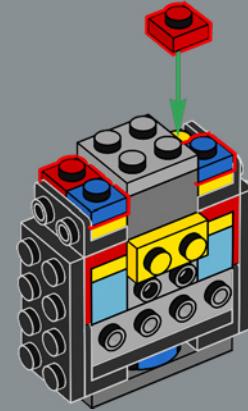

95

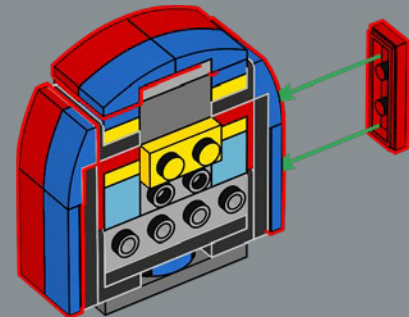

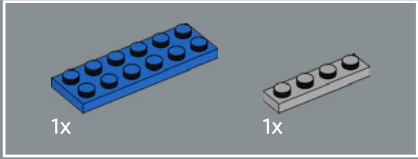
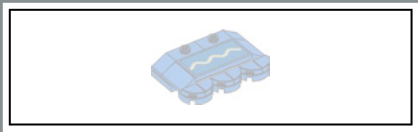

96

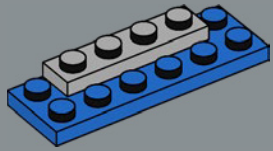

97

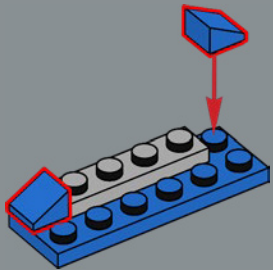

98

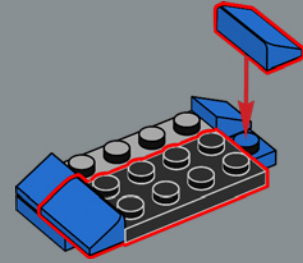

99

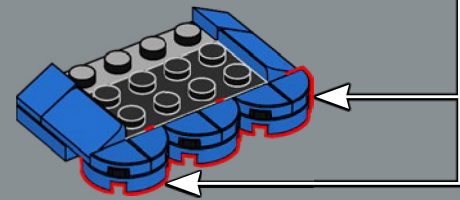
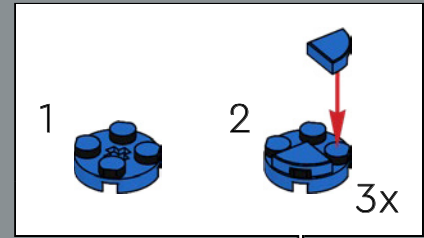

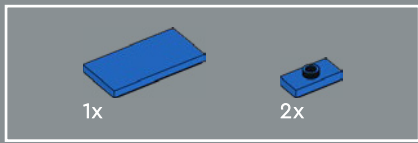

100

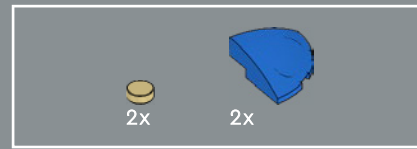
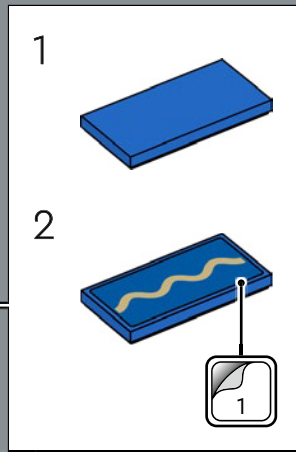
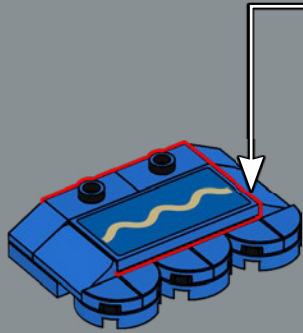

102

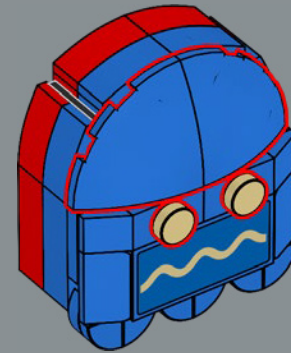

101

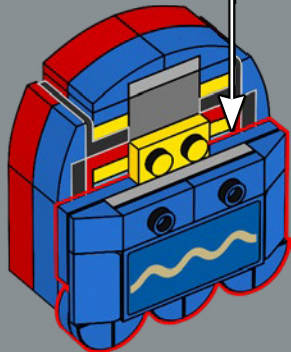

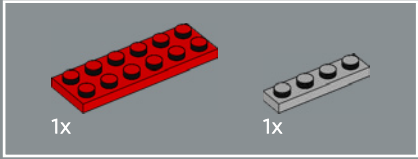
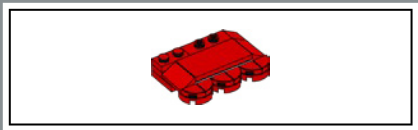

103

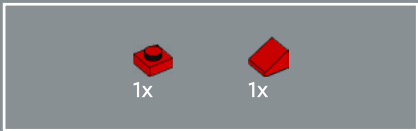
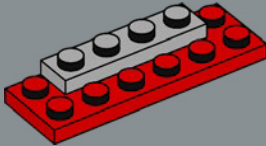

104

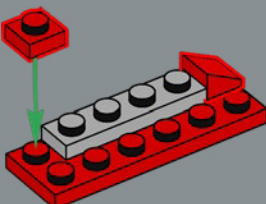

105

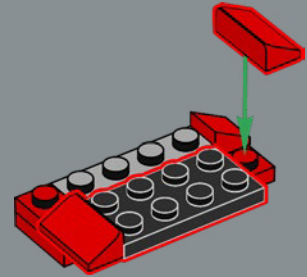

106

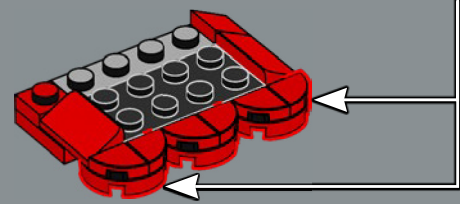
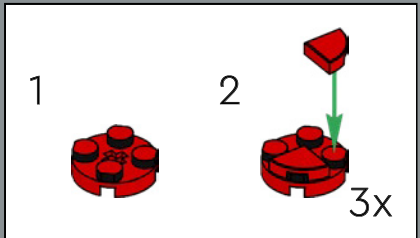

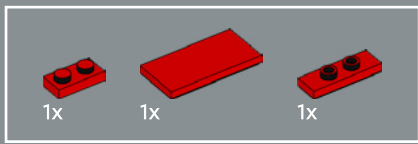

107

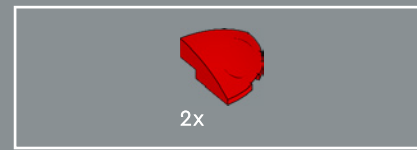
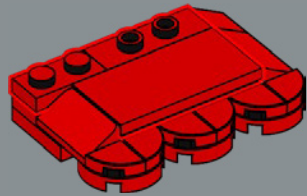

109

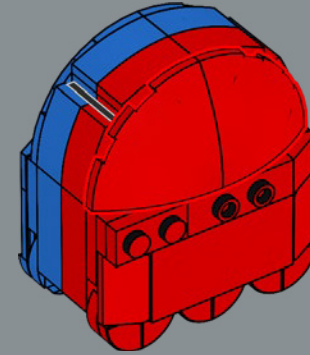

108

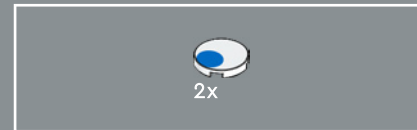
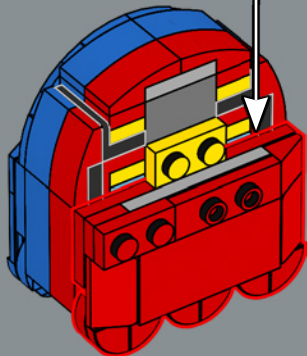

110

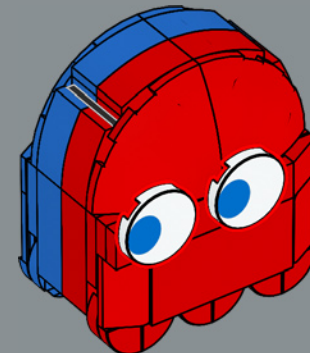

111

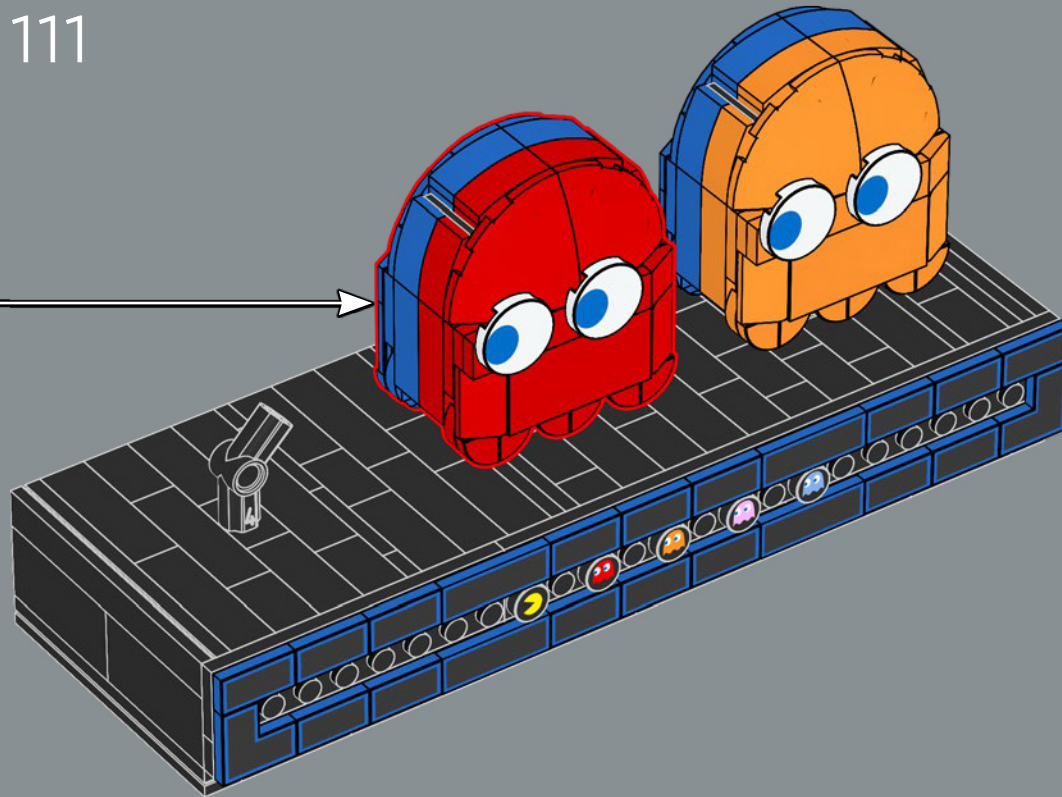



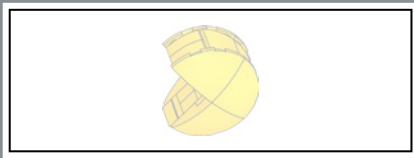

112

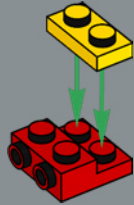

113

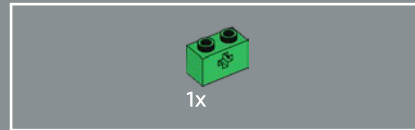
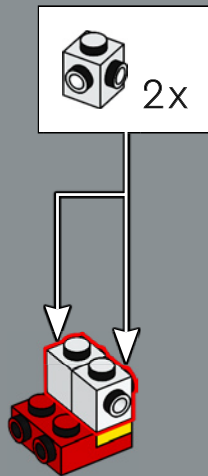

114

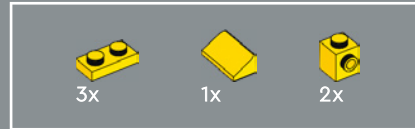
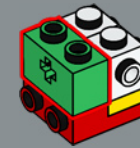

115

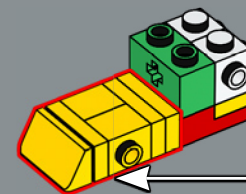
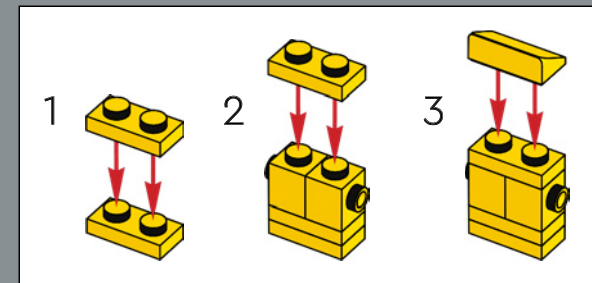

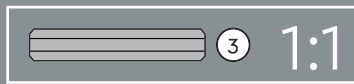
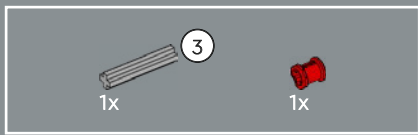

116

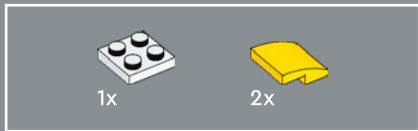
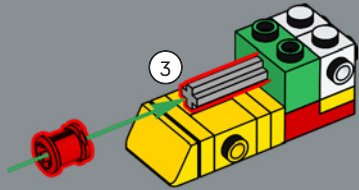

117

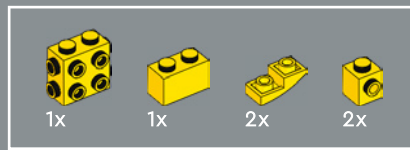
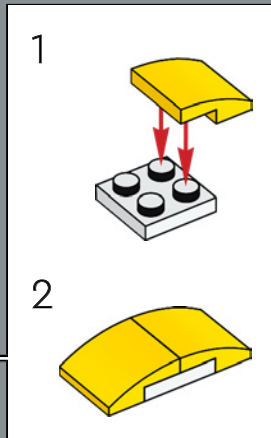
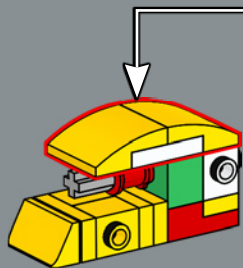

118

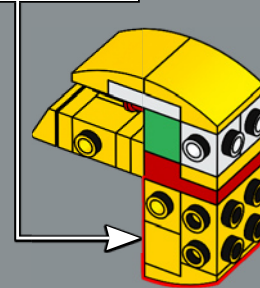
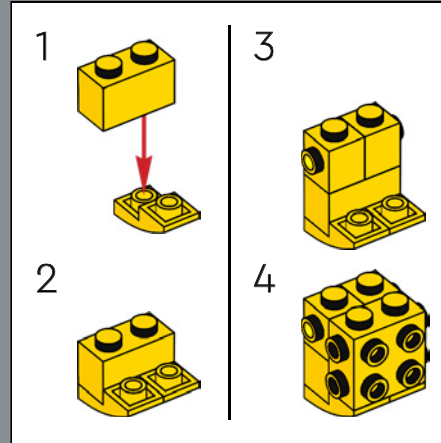

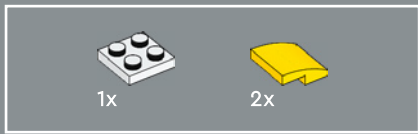

119

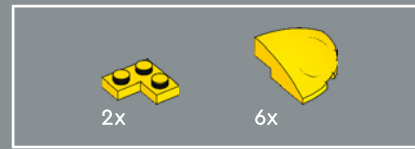
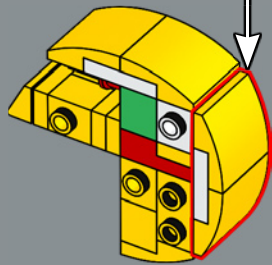
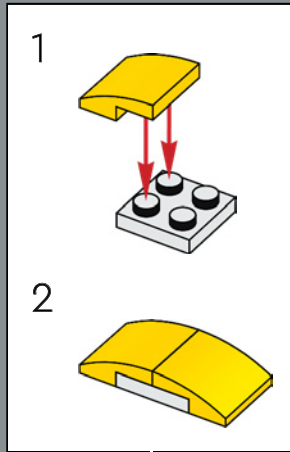

120

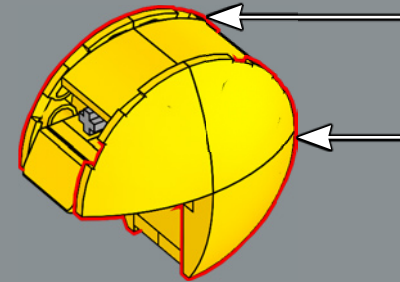
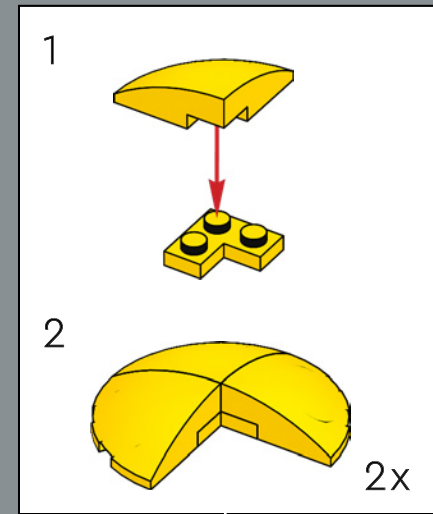

121

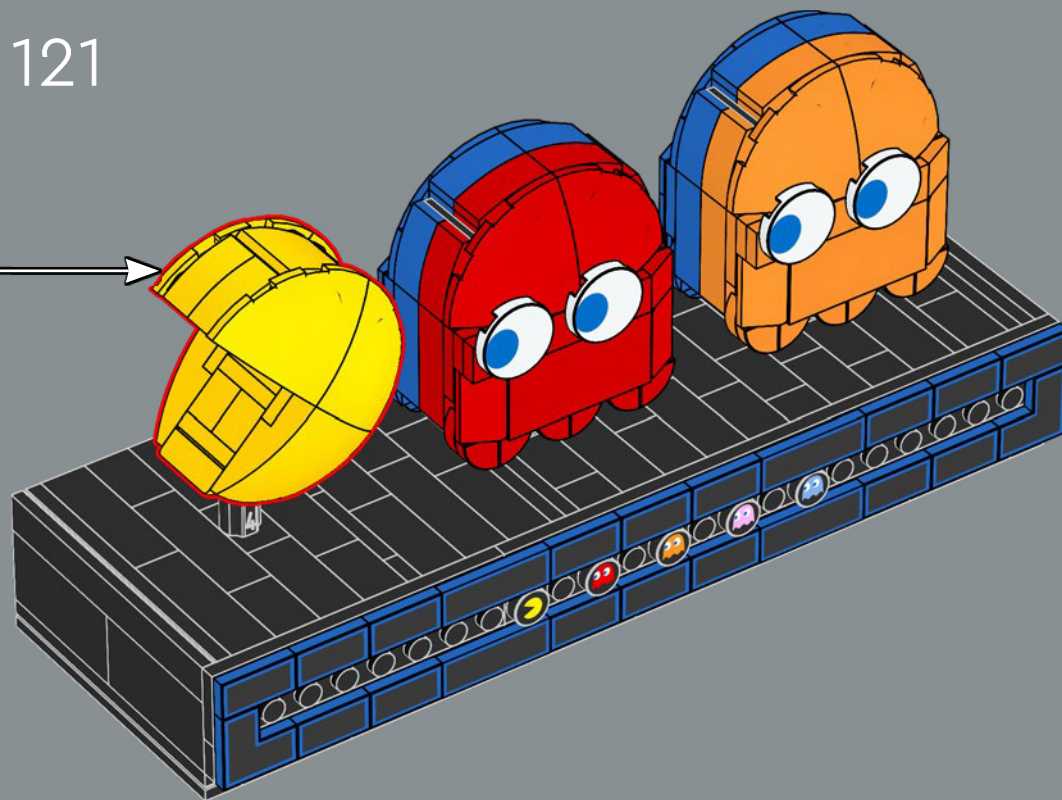

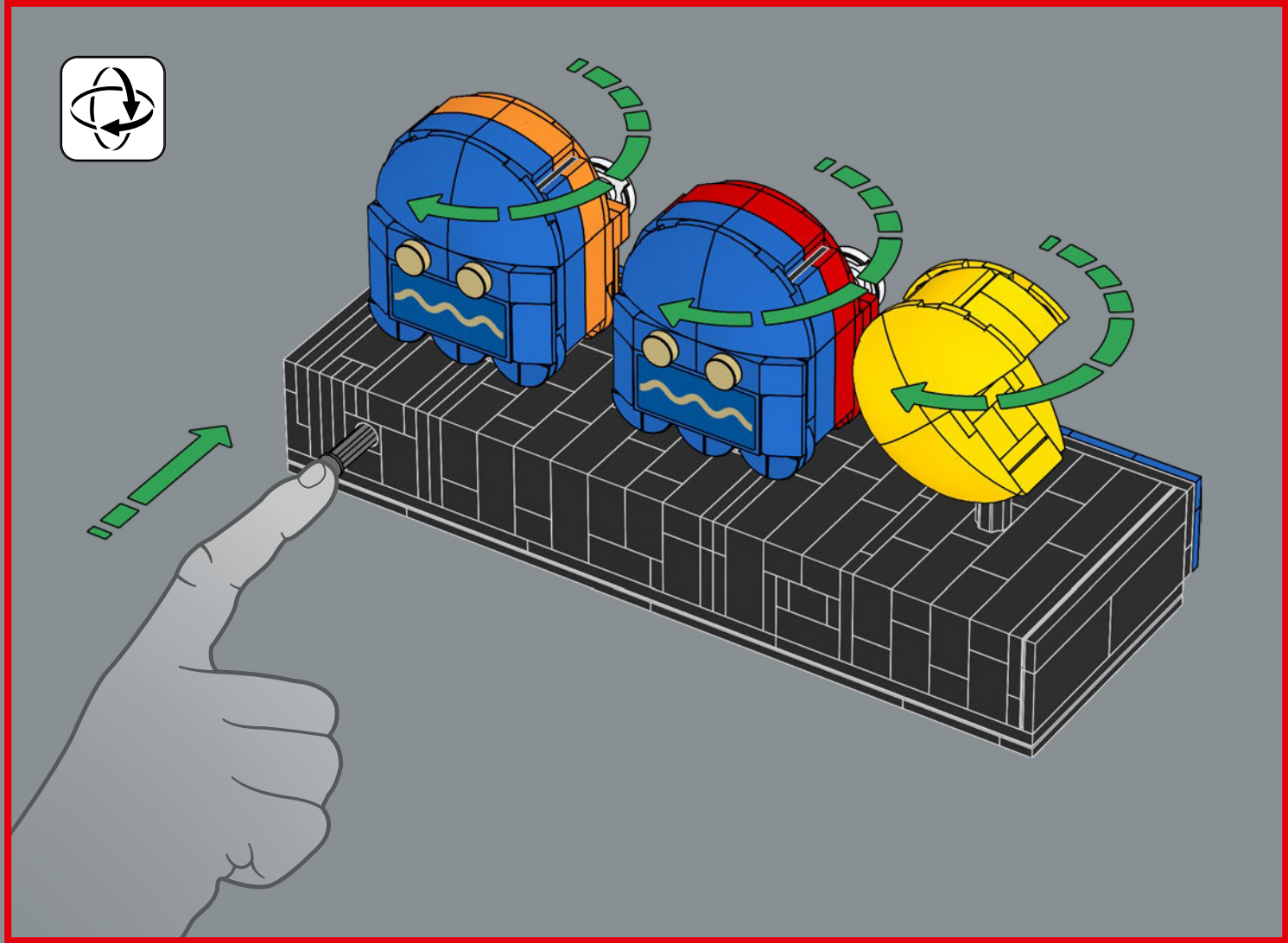

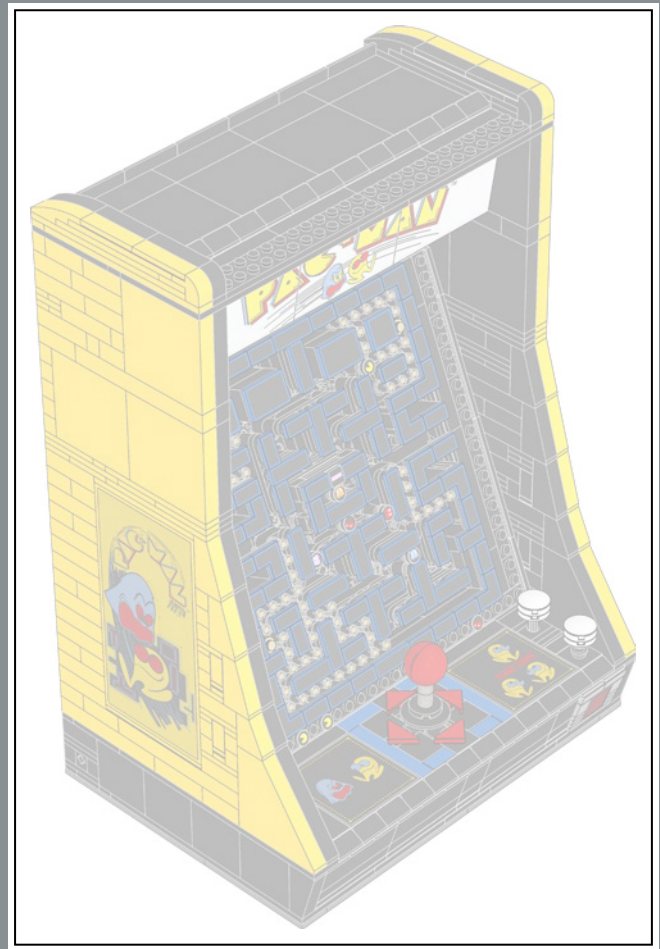
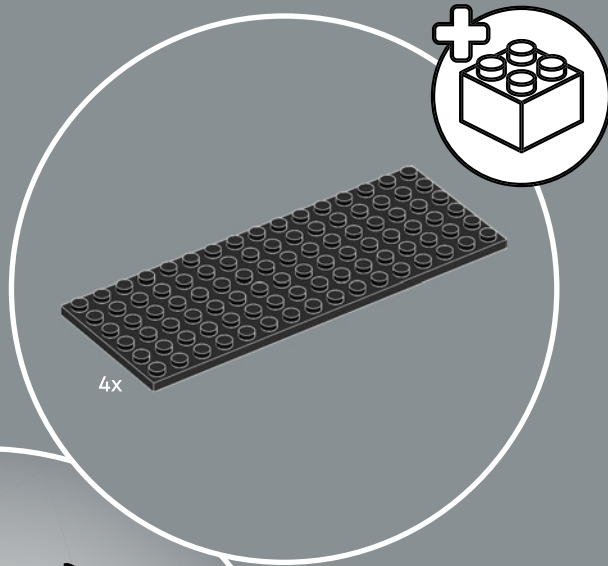
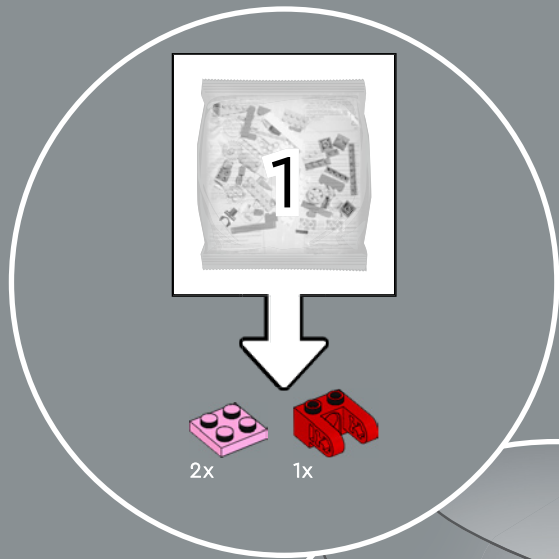

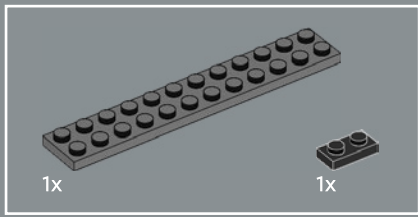

1

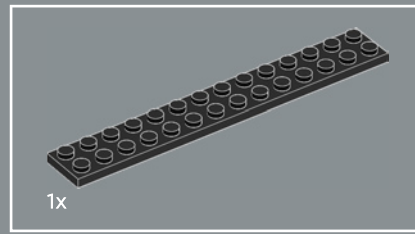
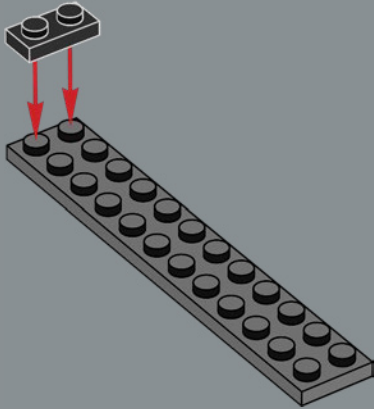

2

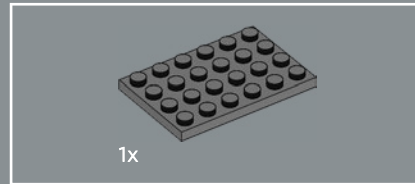
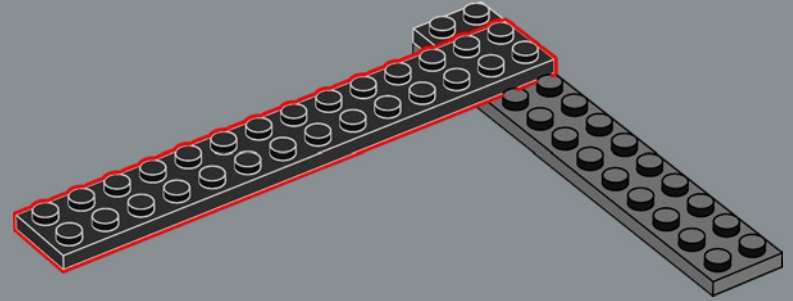

3

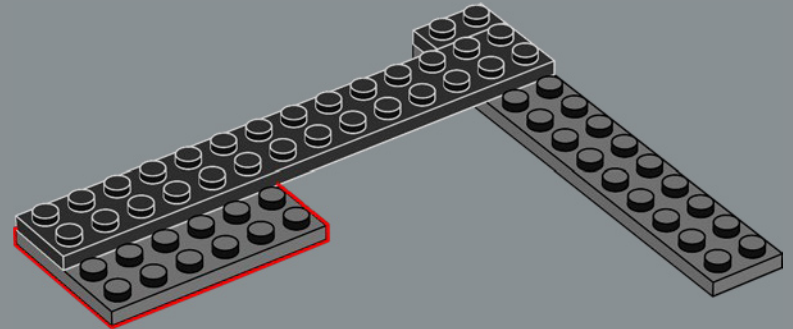

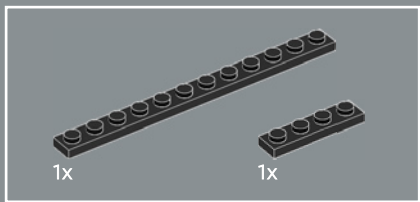

4

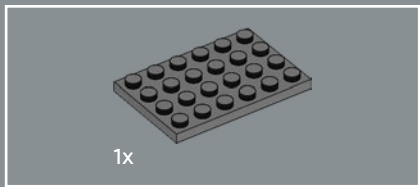
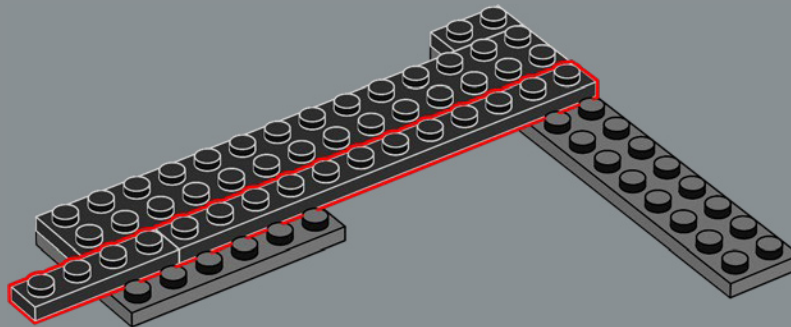

5

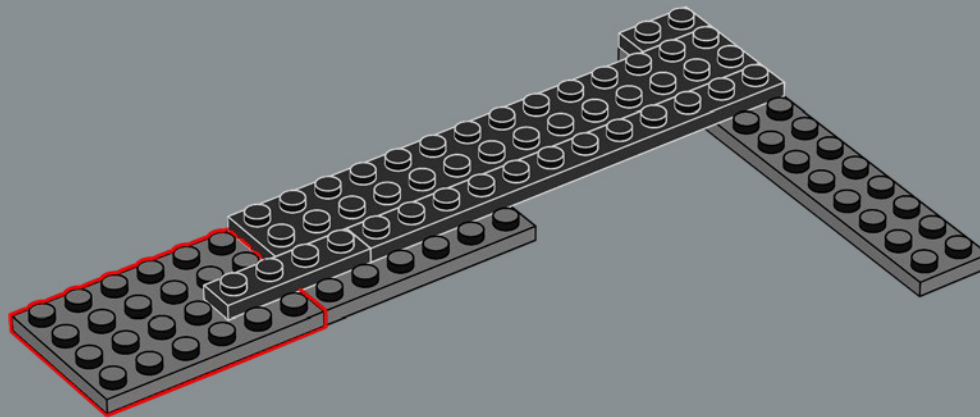



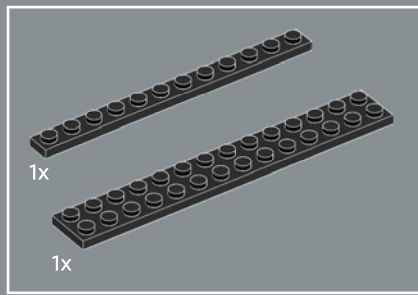

6

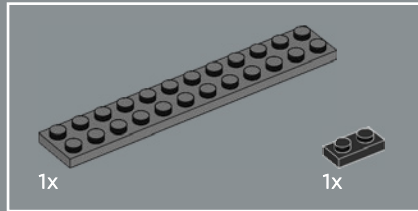
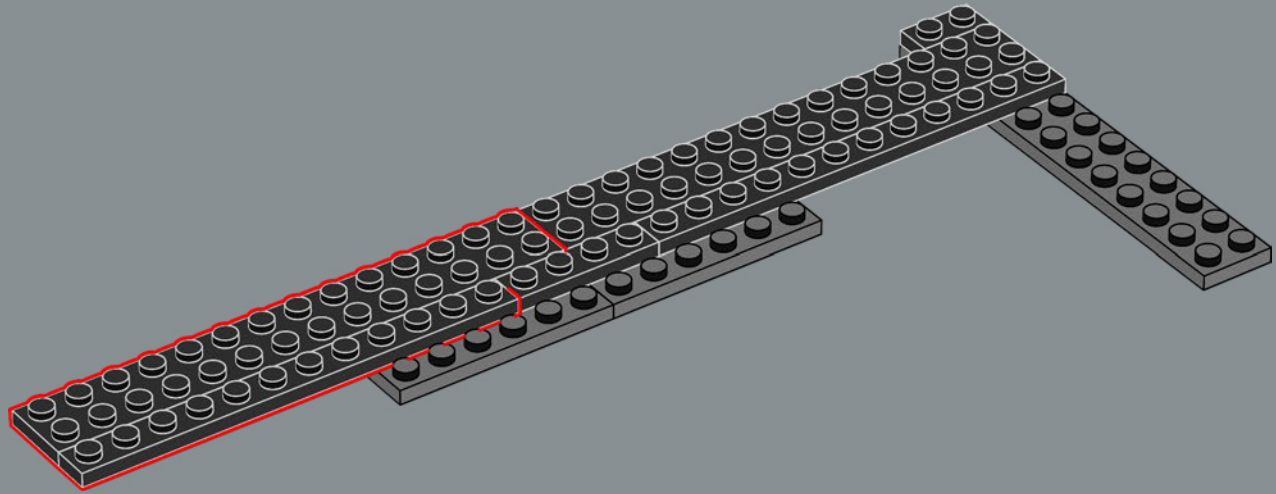

7

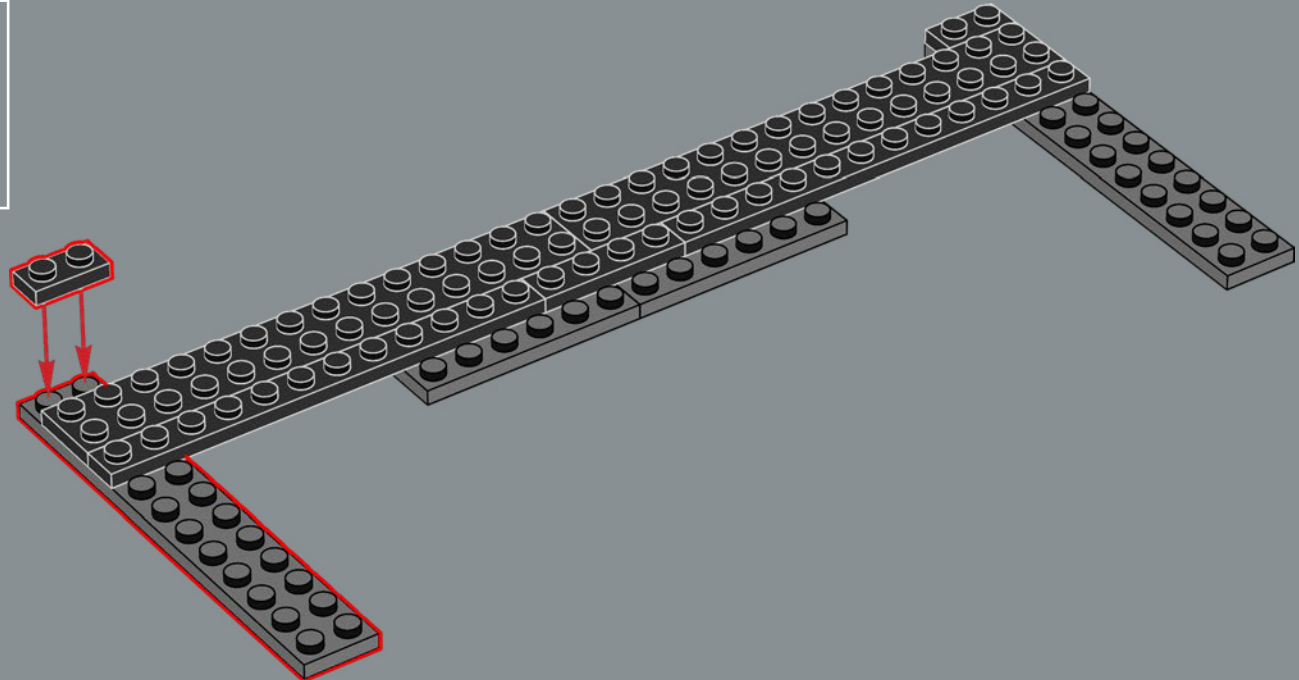

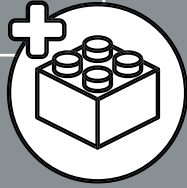
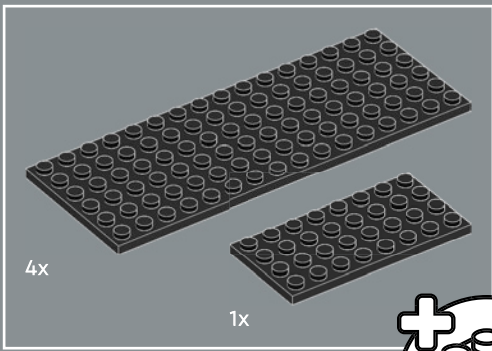

8

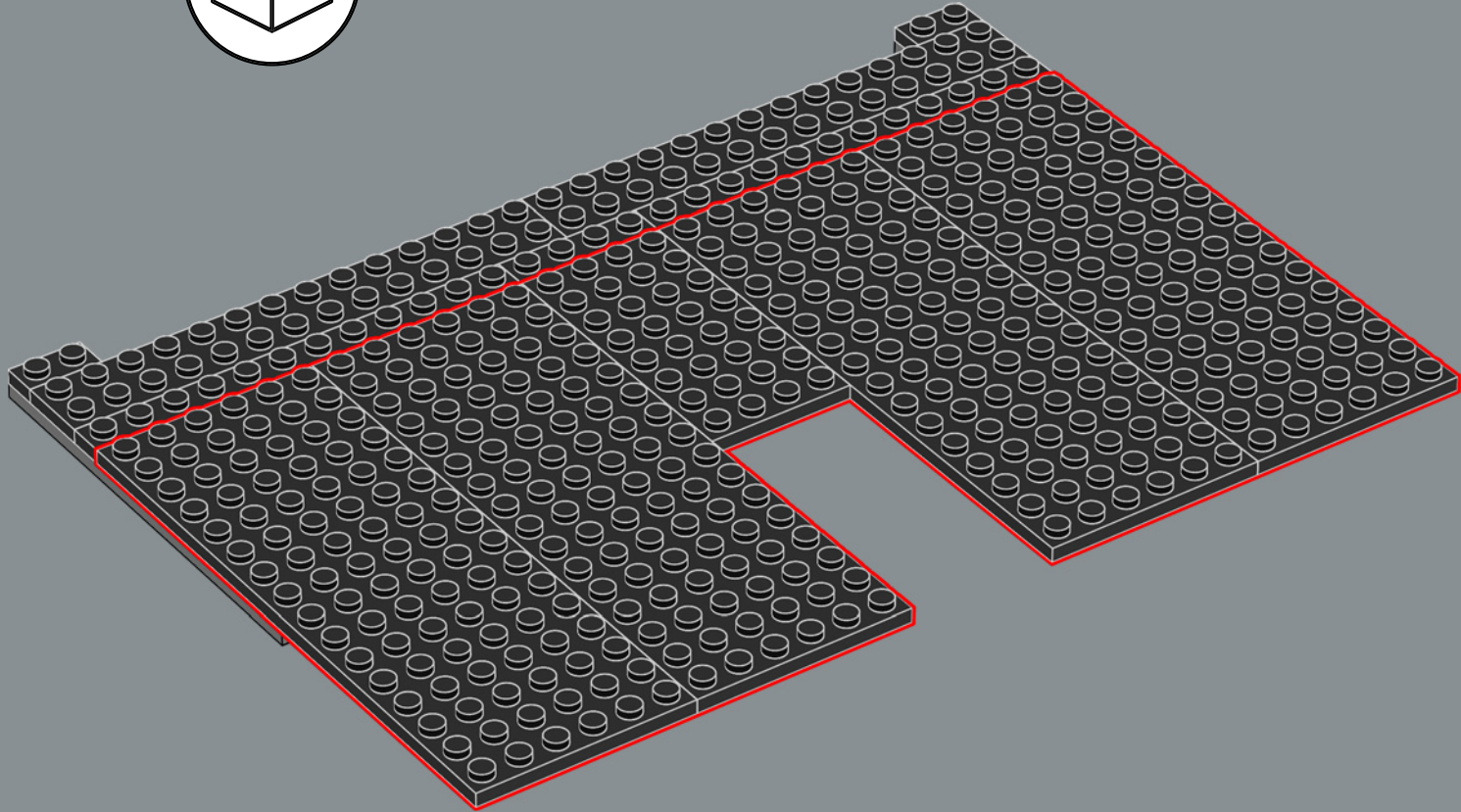

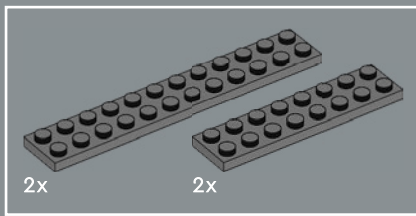

9

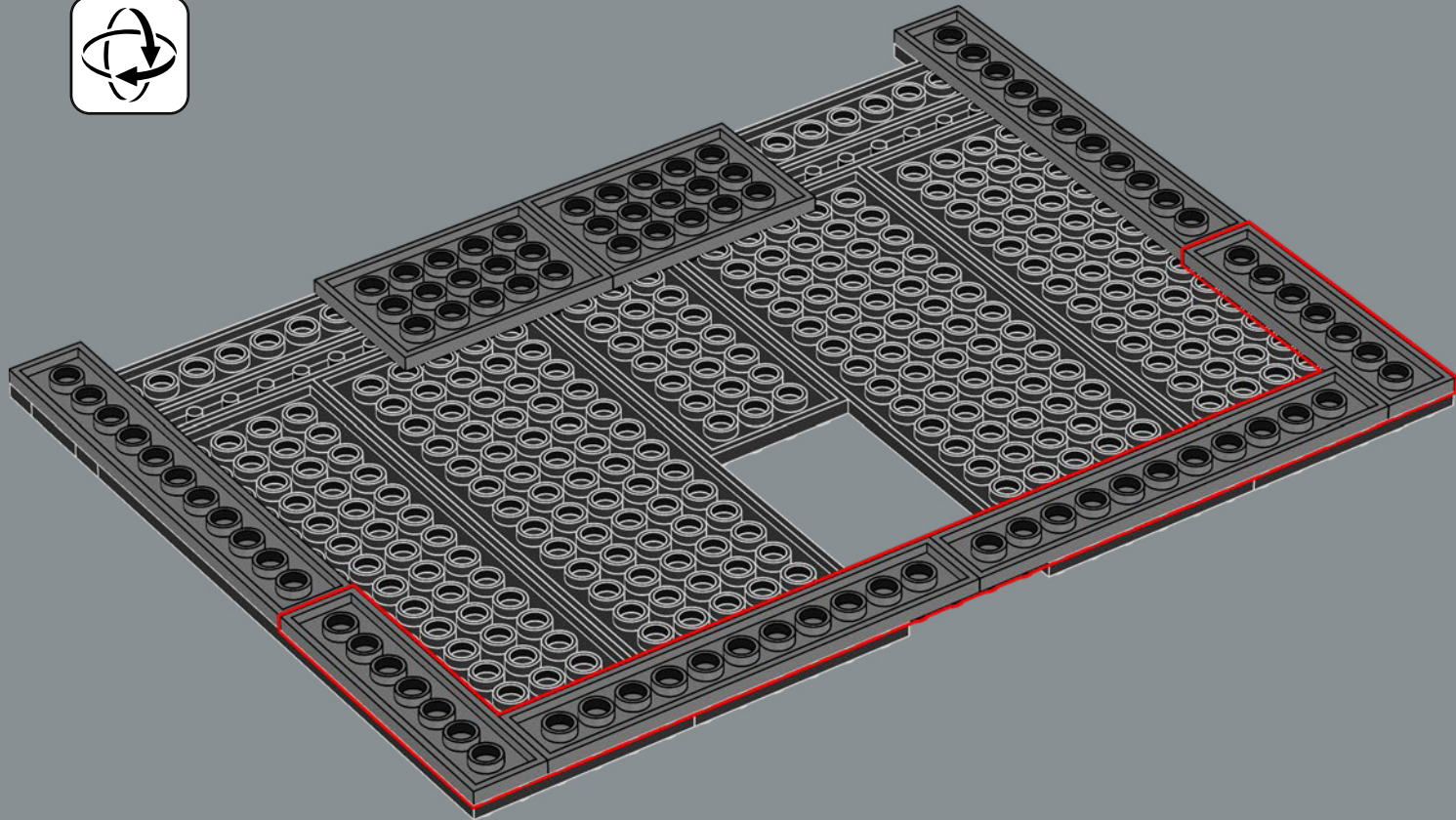

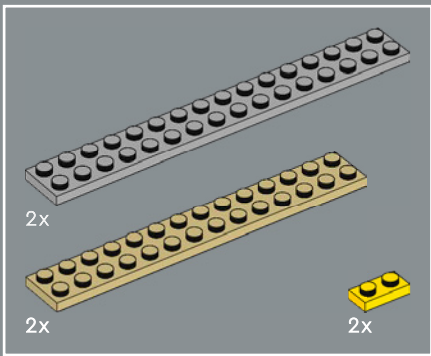

10

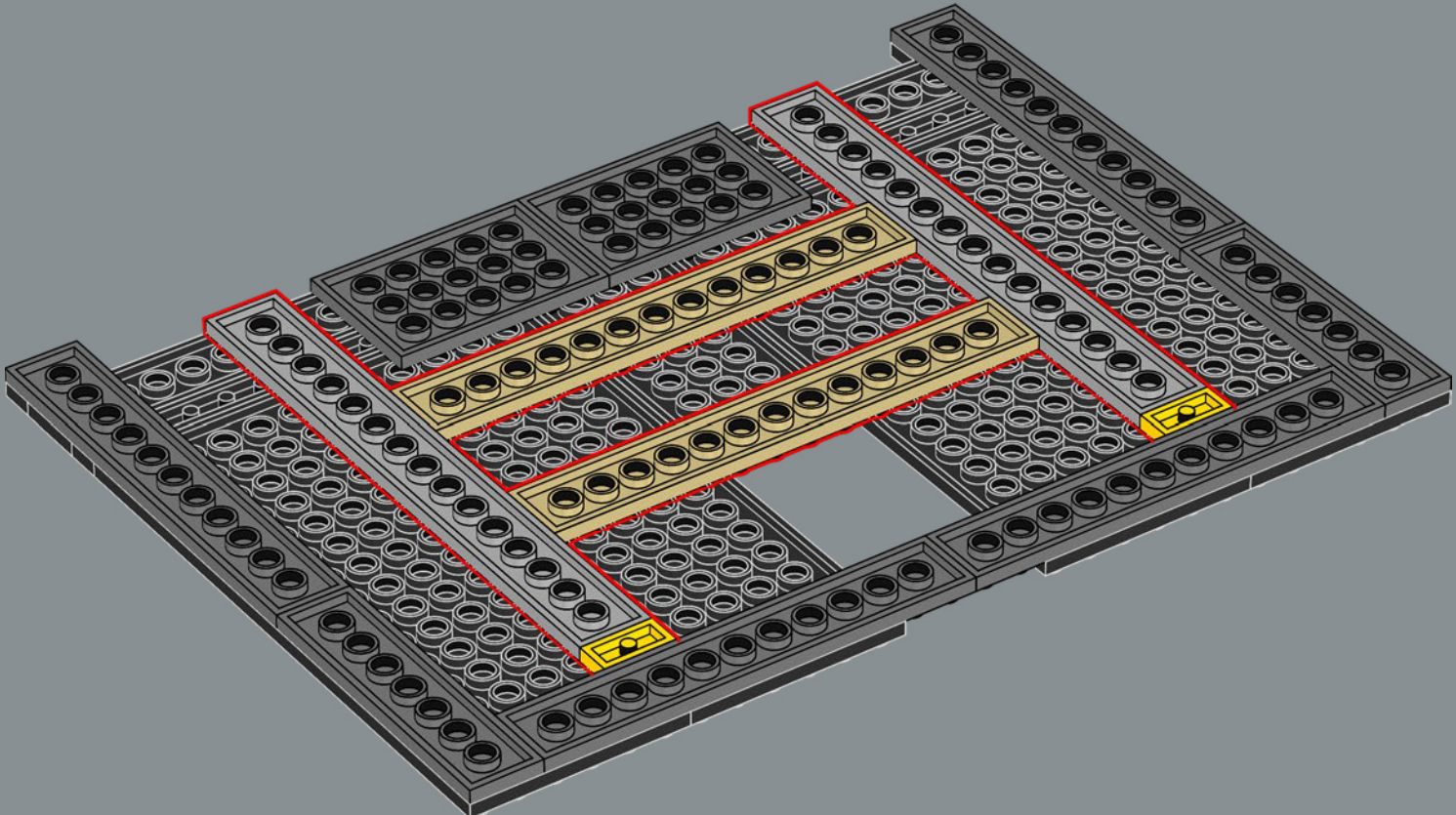

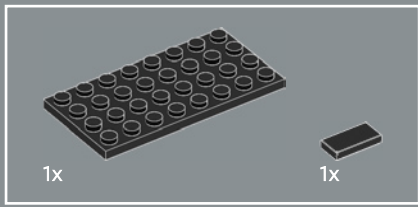

11

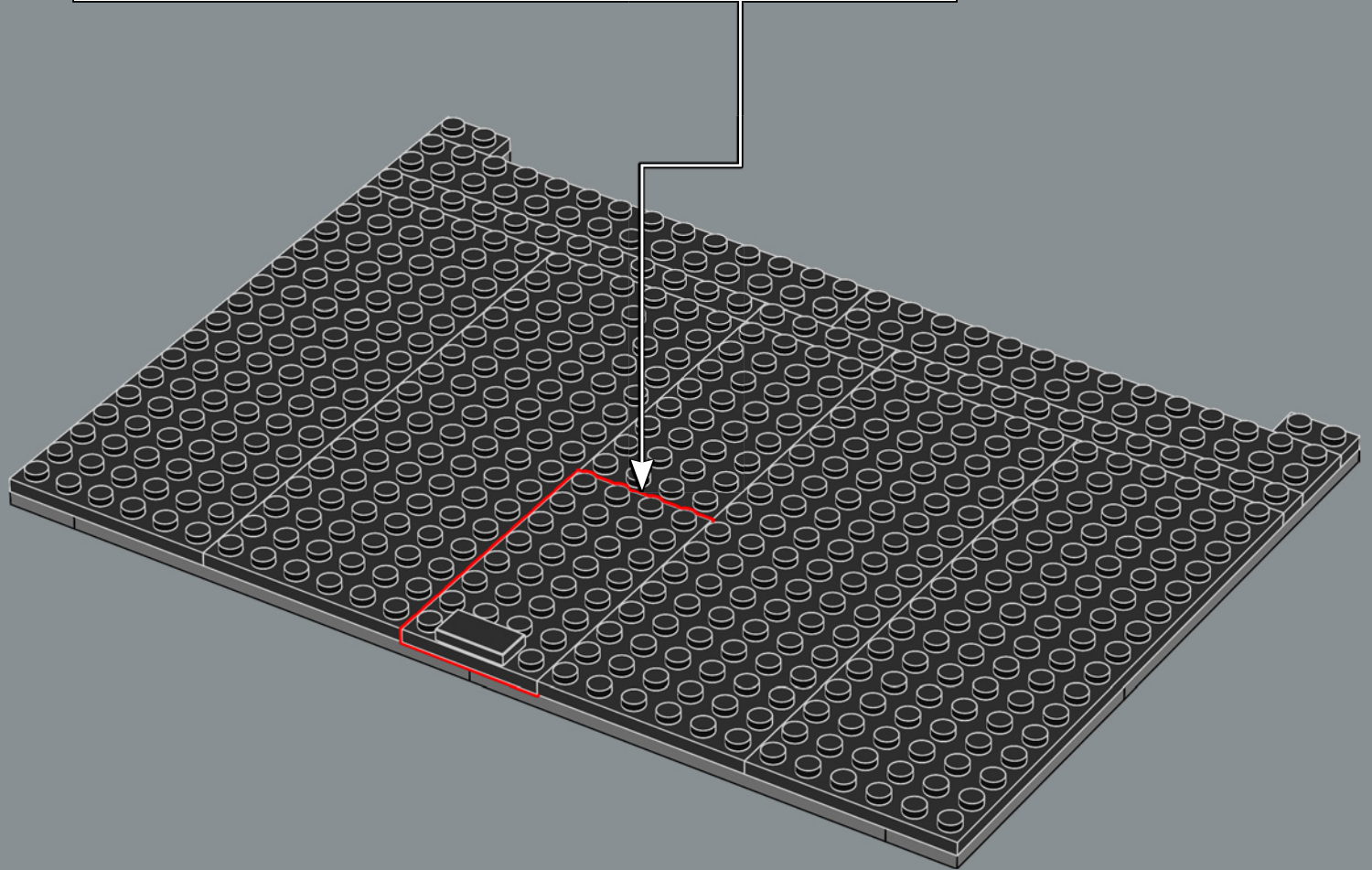
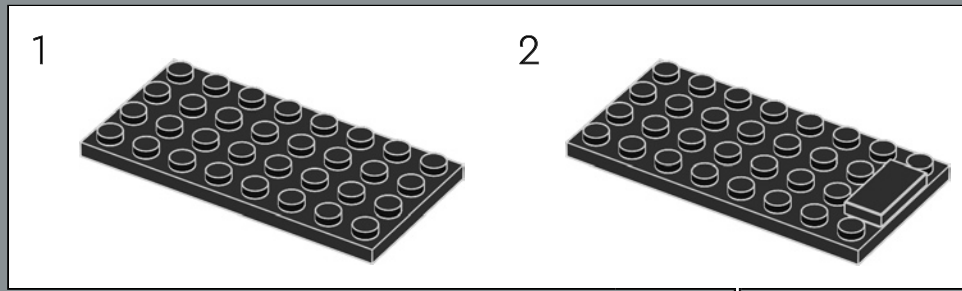



2x



4x



2x



2x

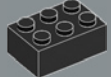

2x

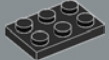

6x



4x

12

1

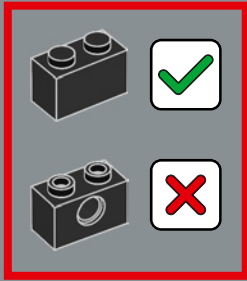
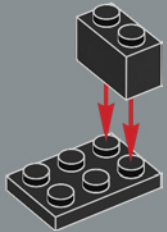

2

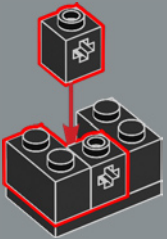

3

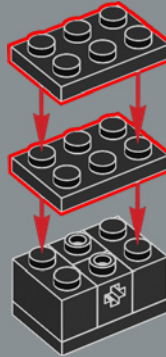

4

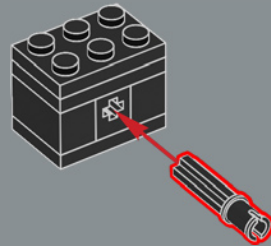

5

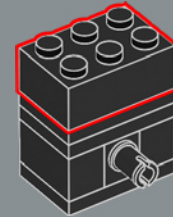

6

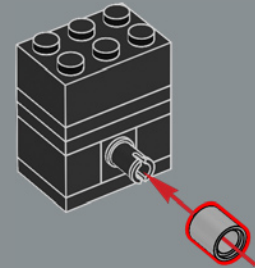

2x



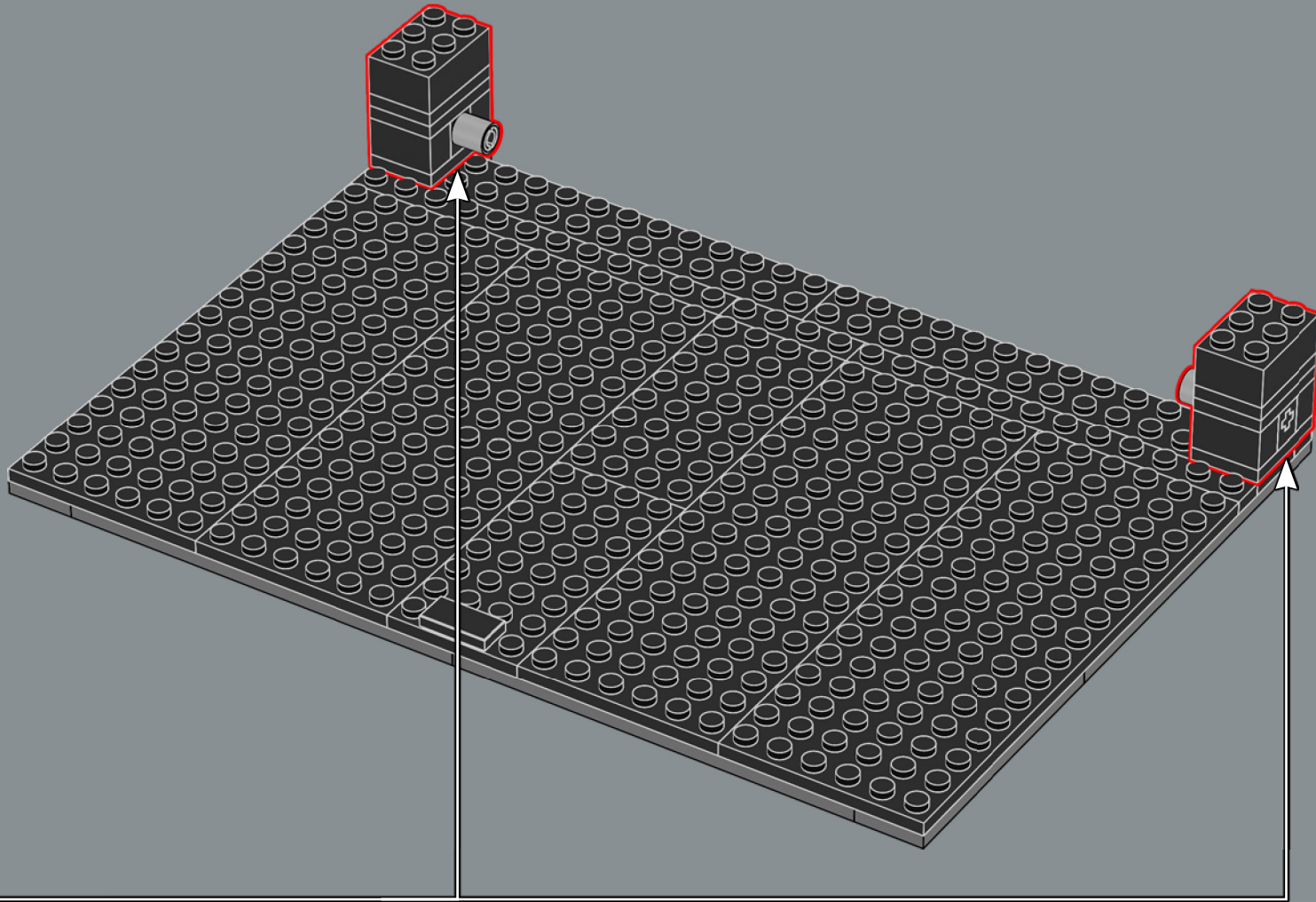

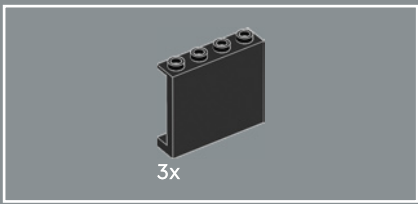

13

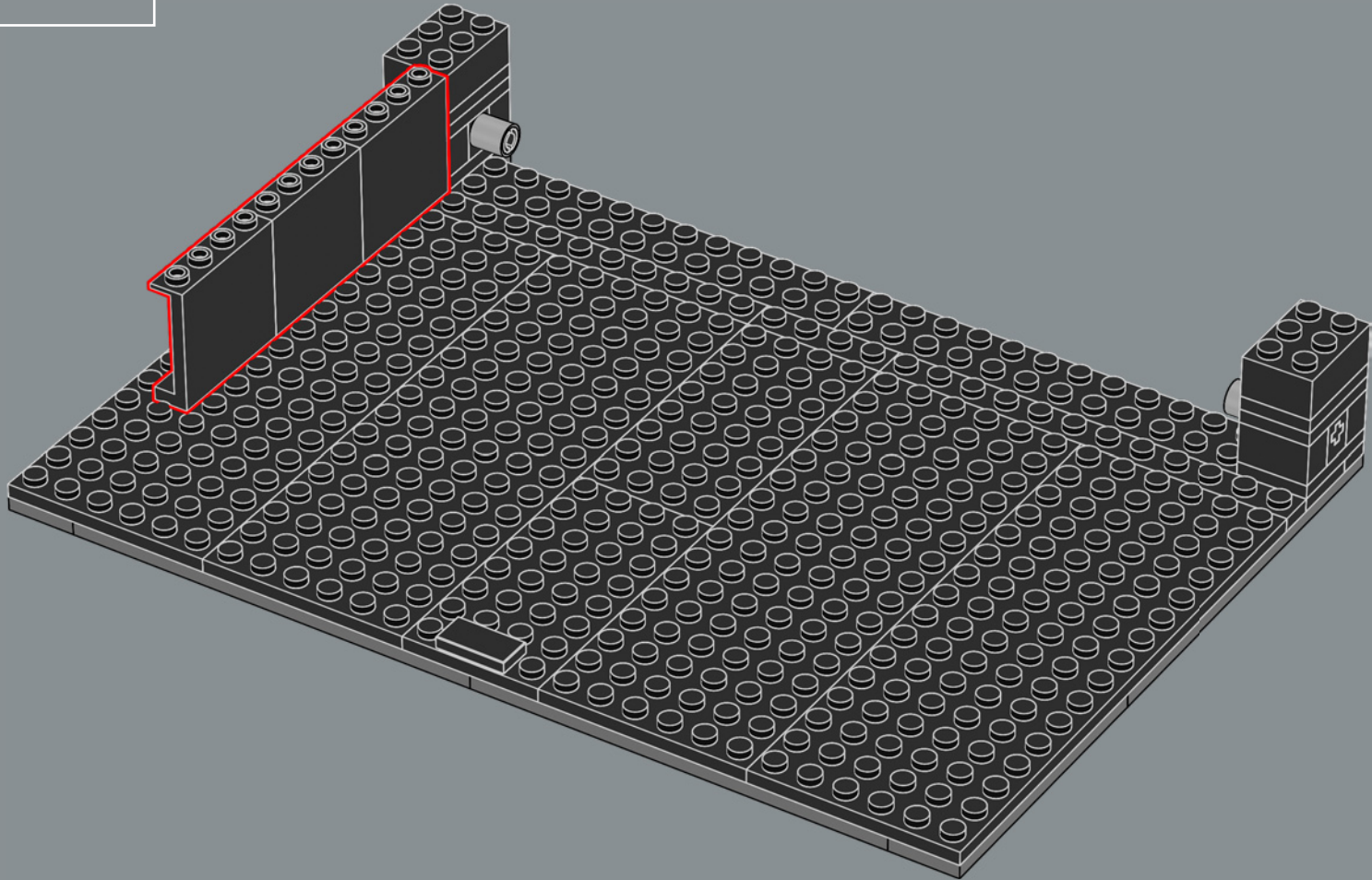



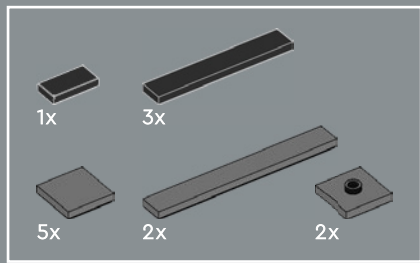

14

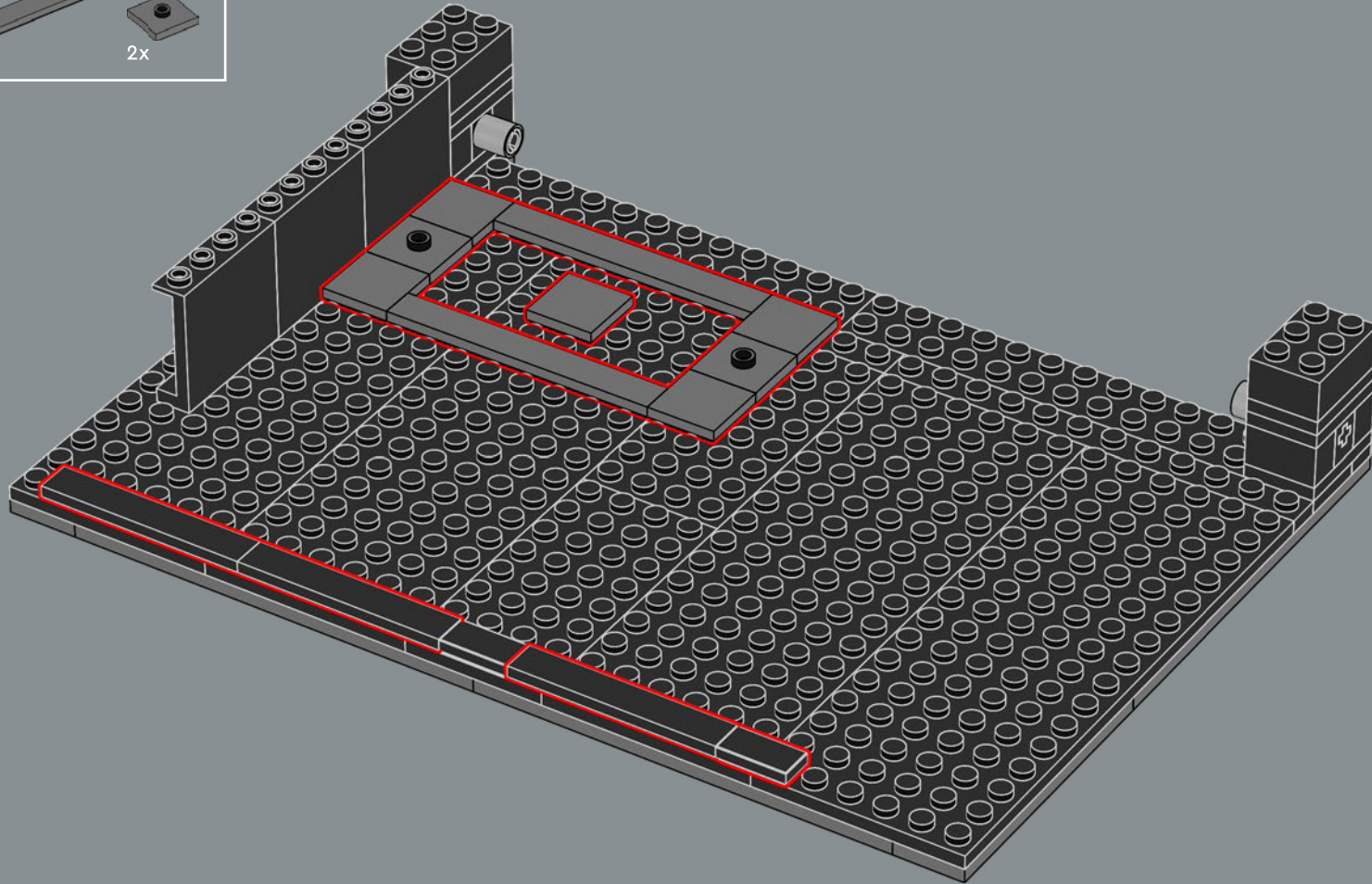

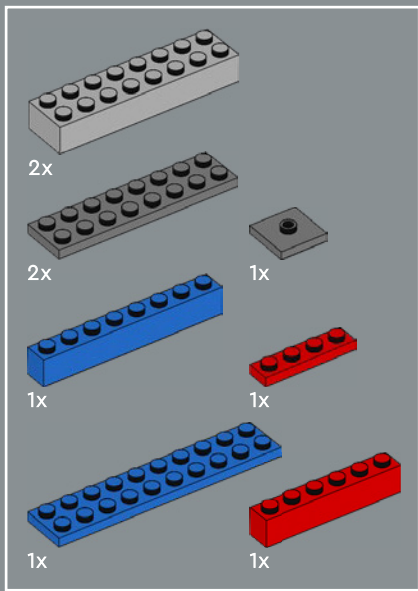

15

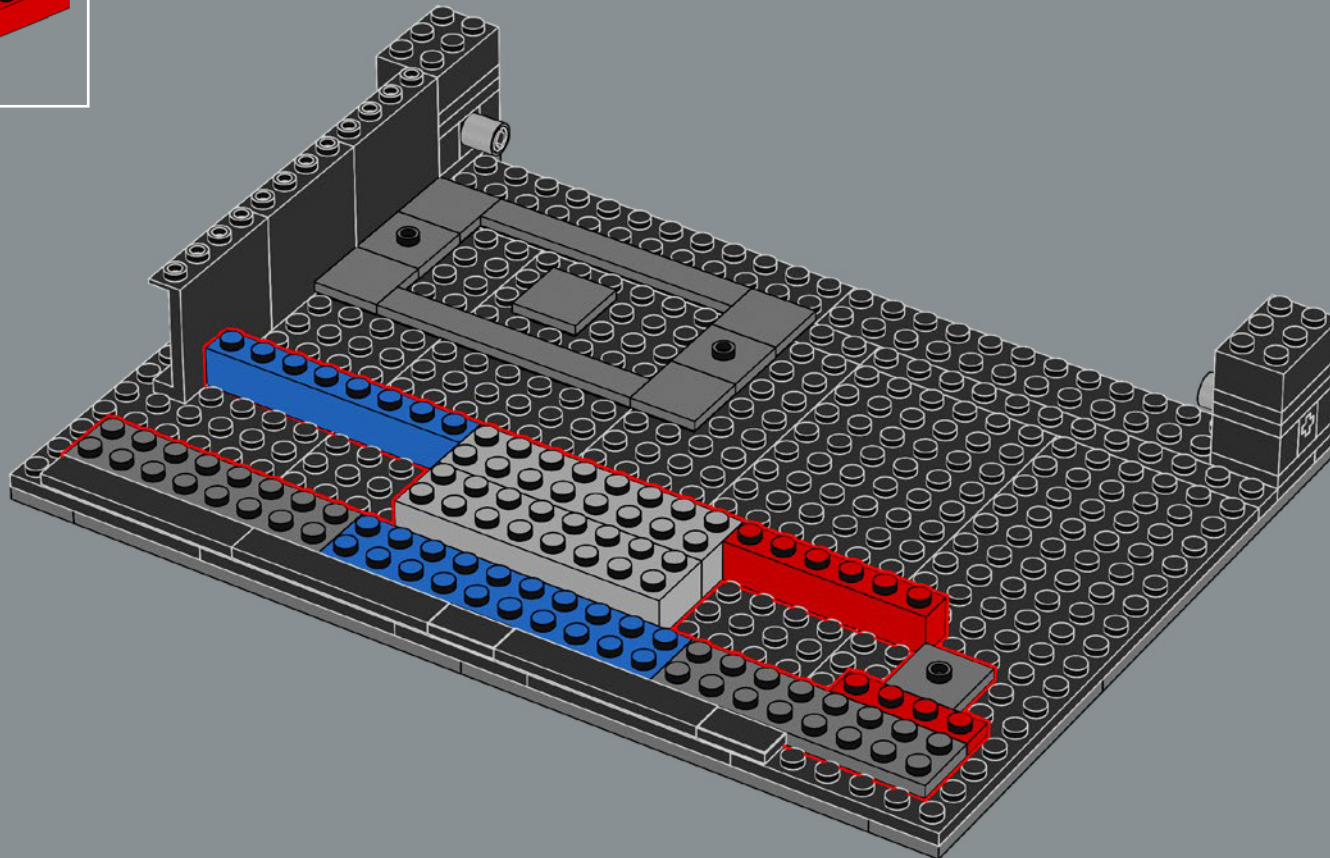



16

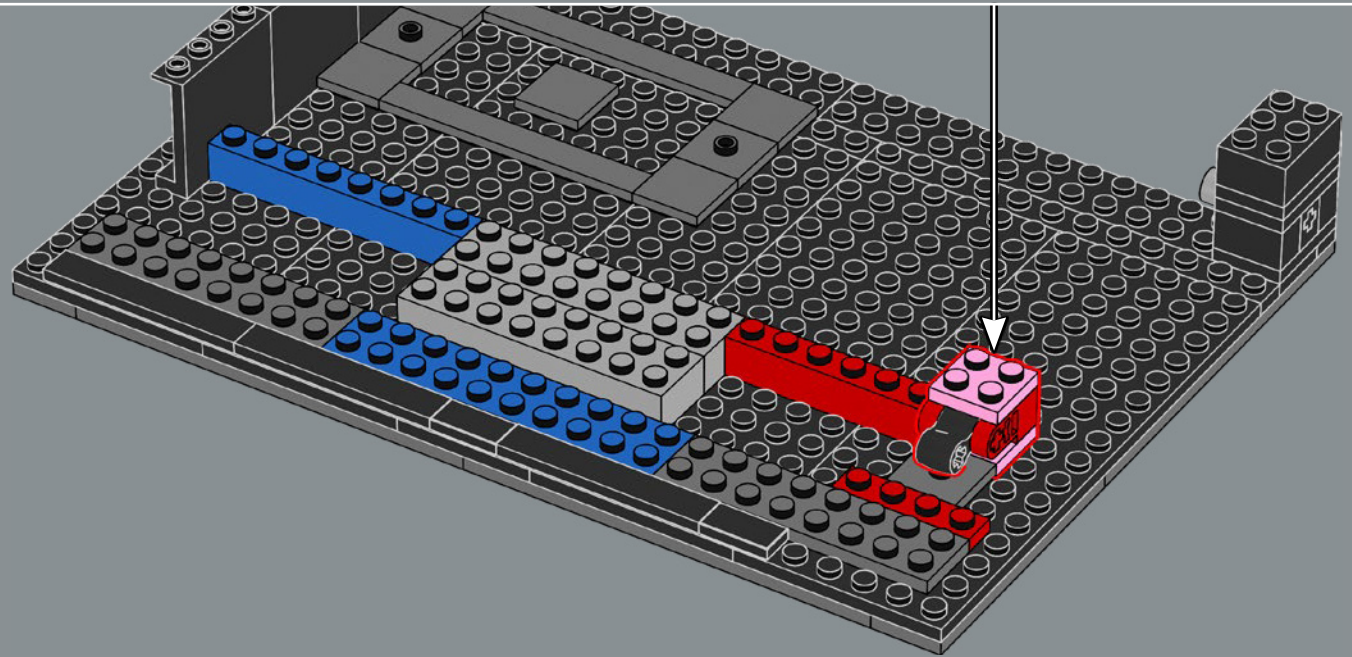
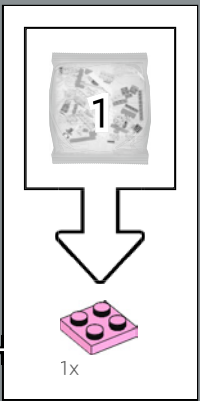
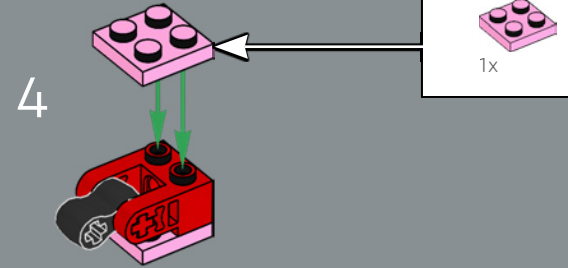
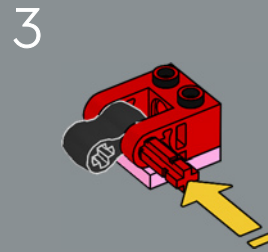
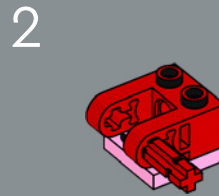
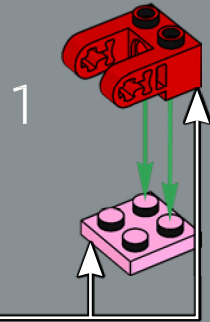
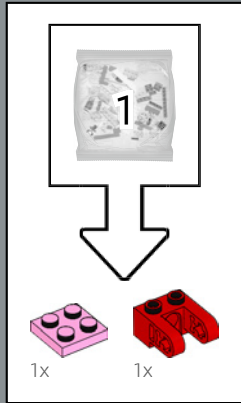

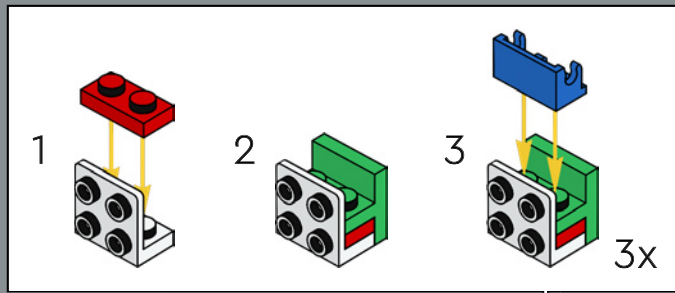
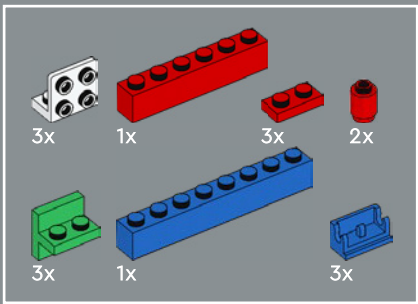

17

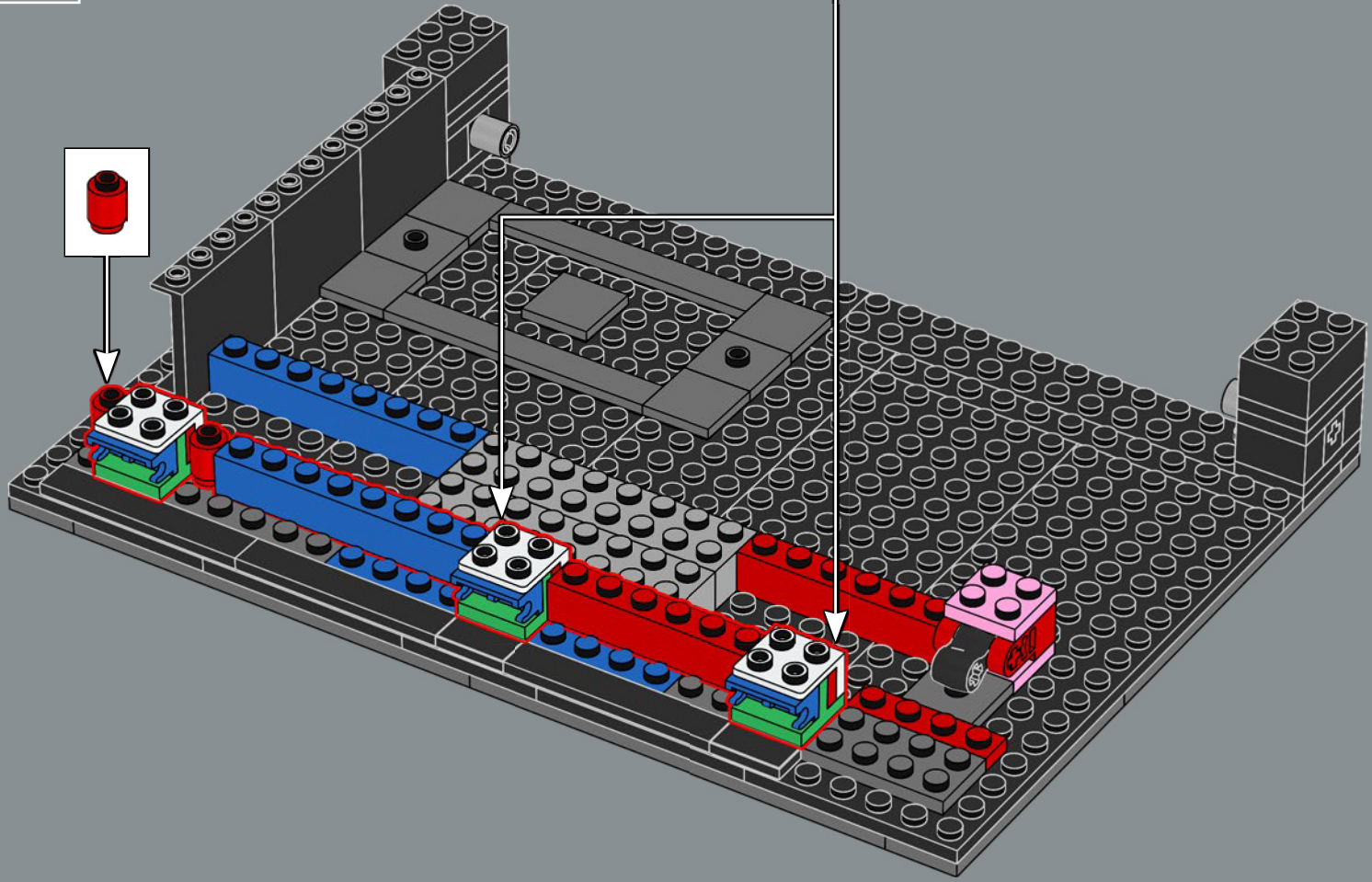



18

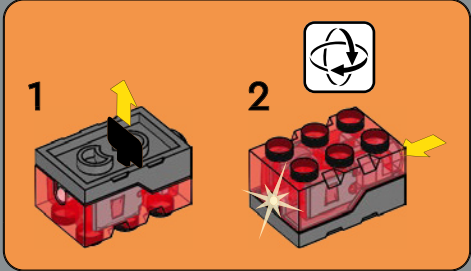
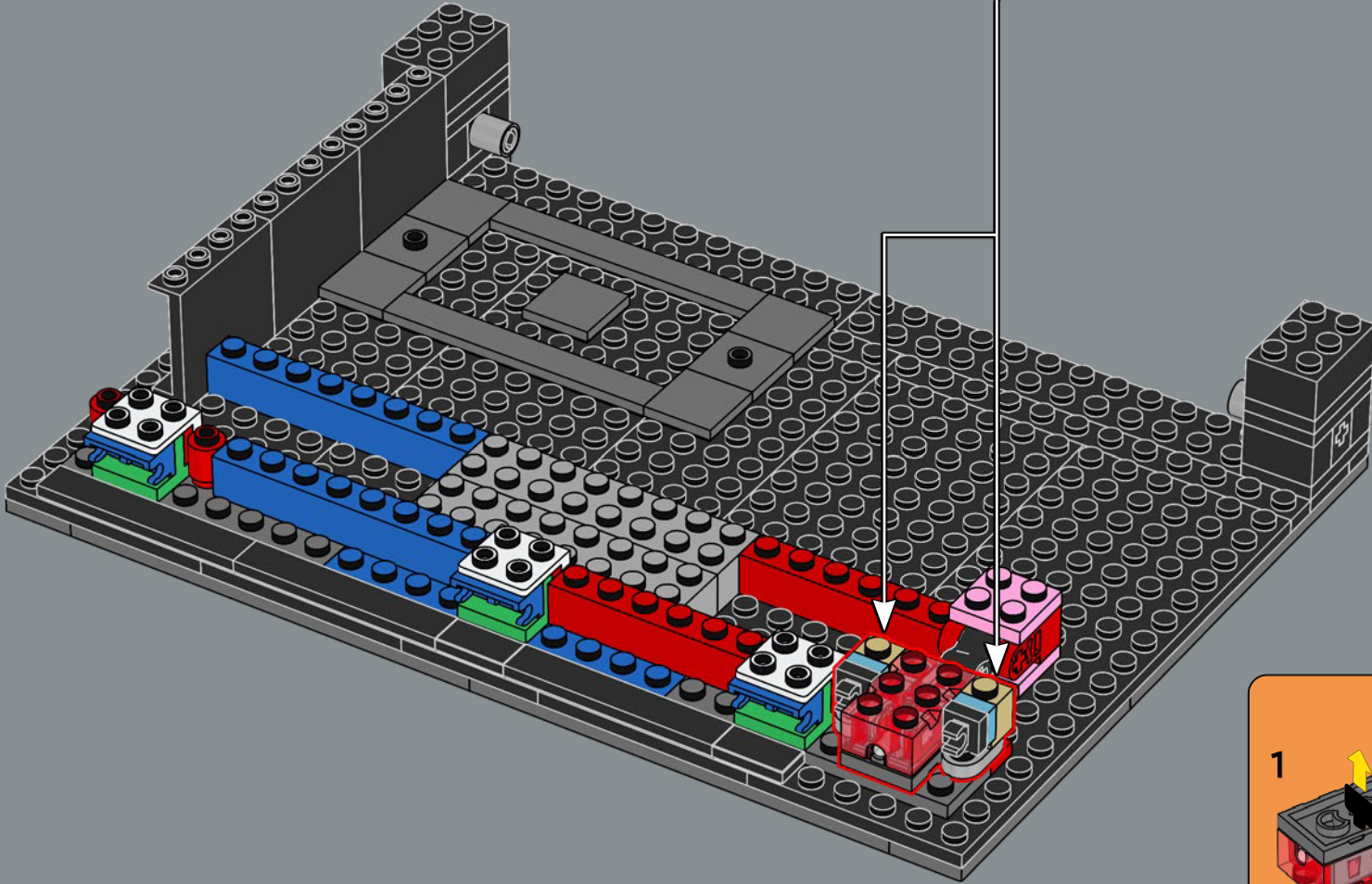
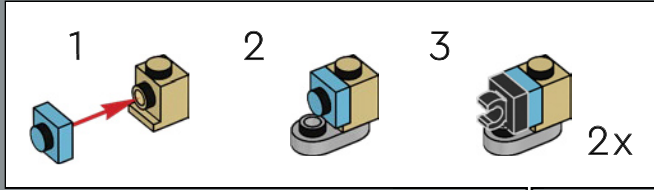

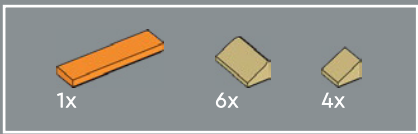

19

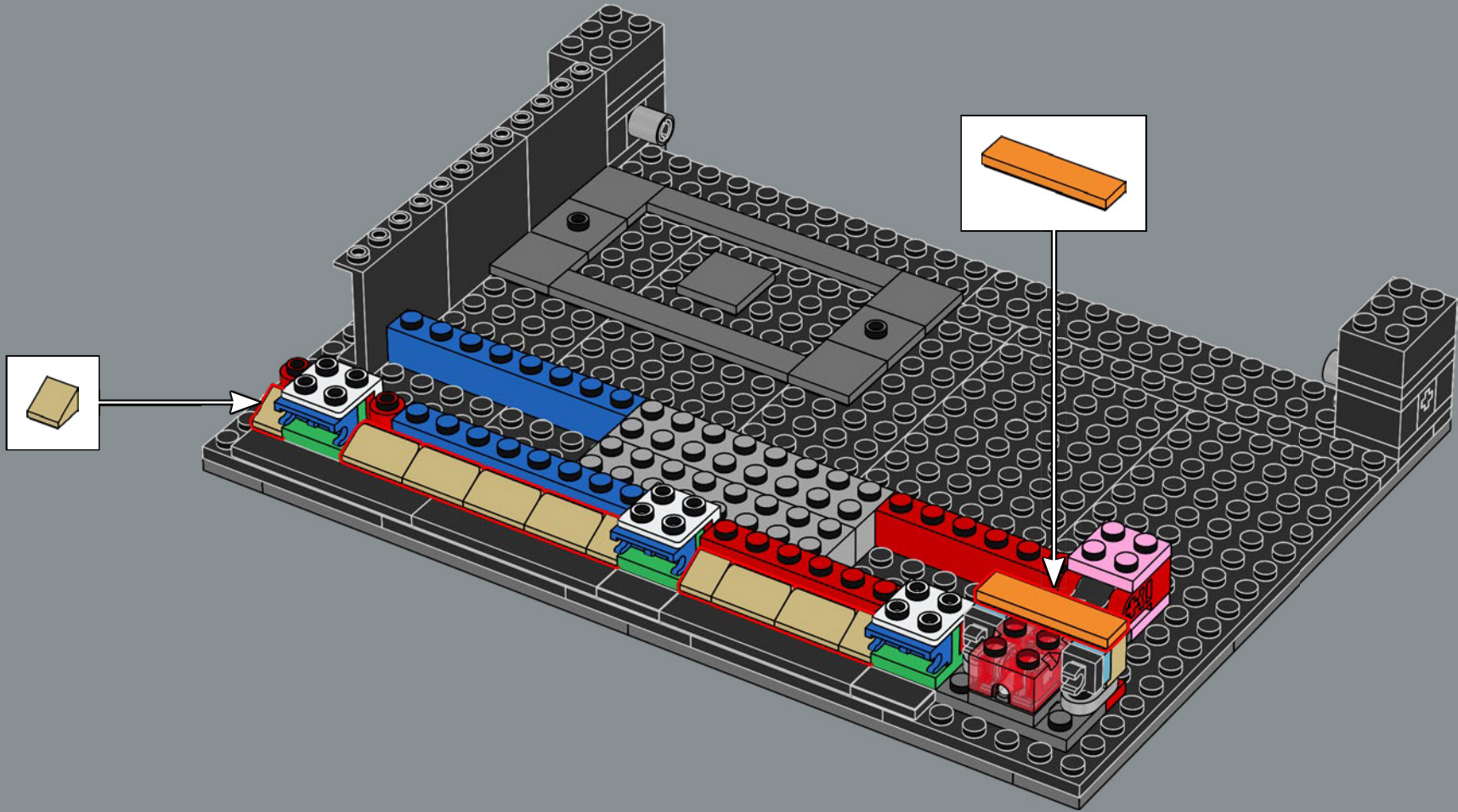

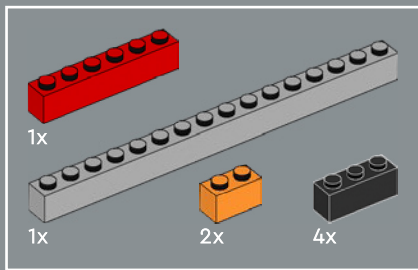

20

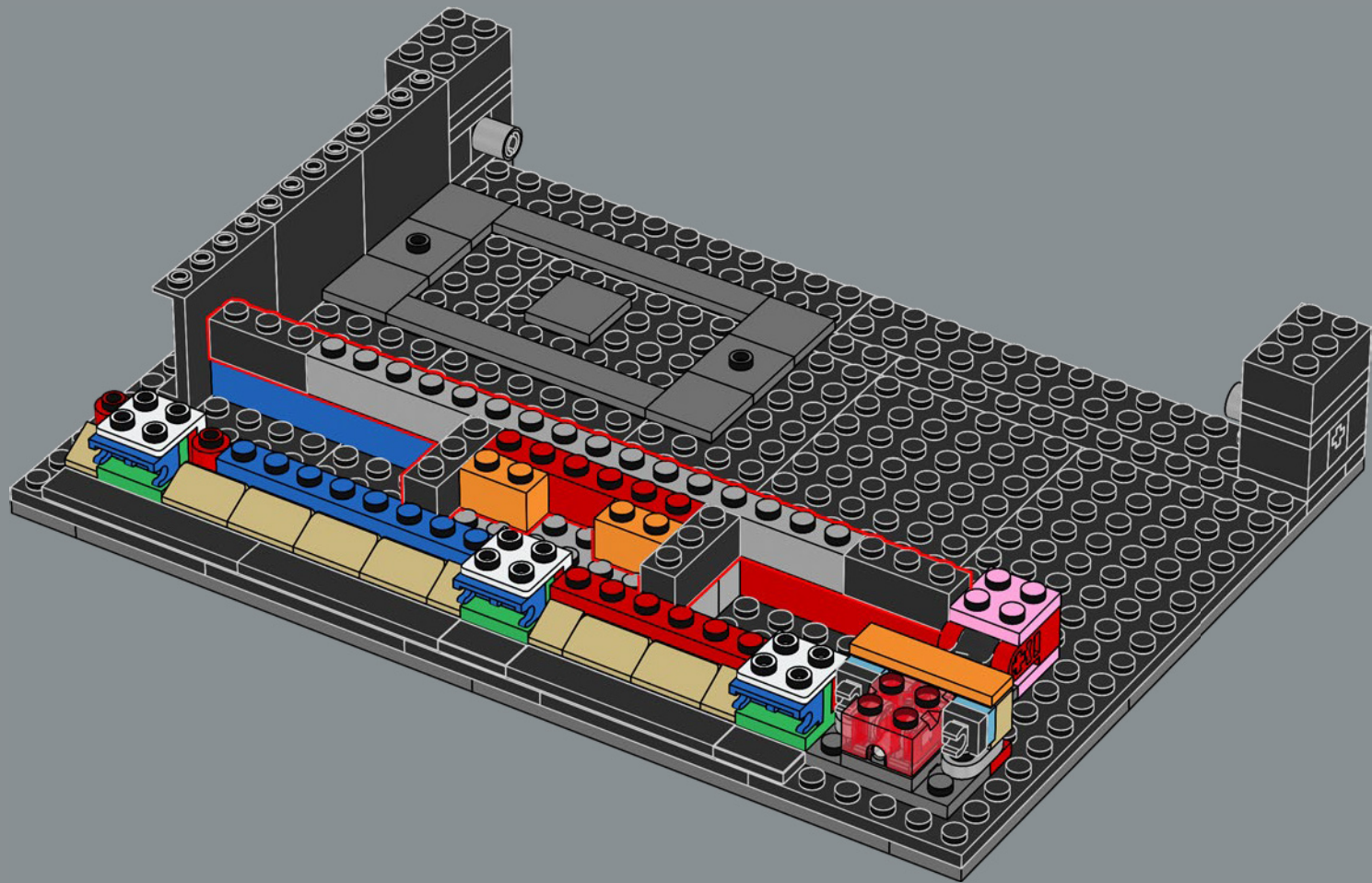

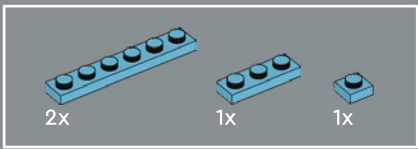

21

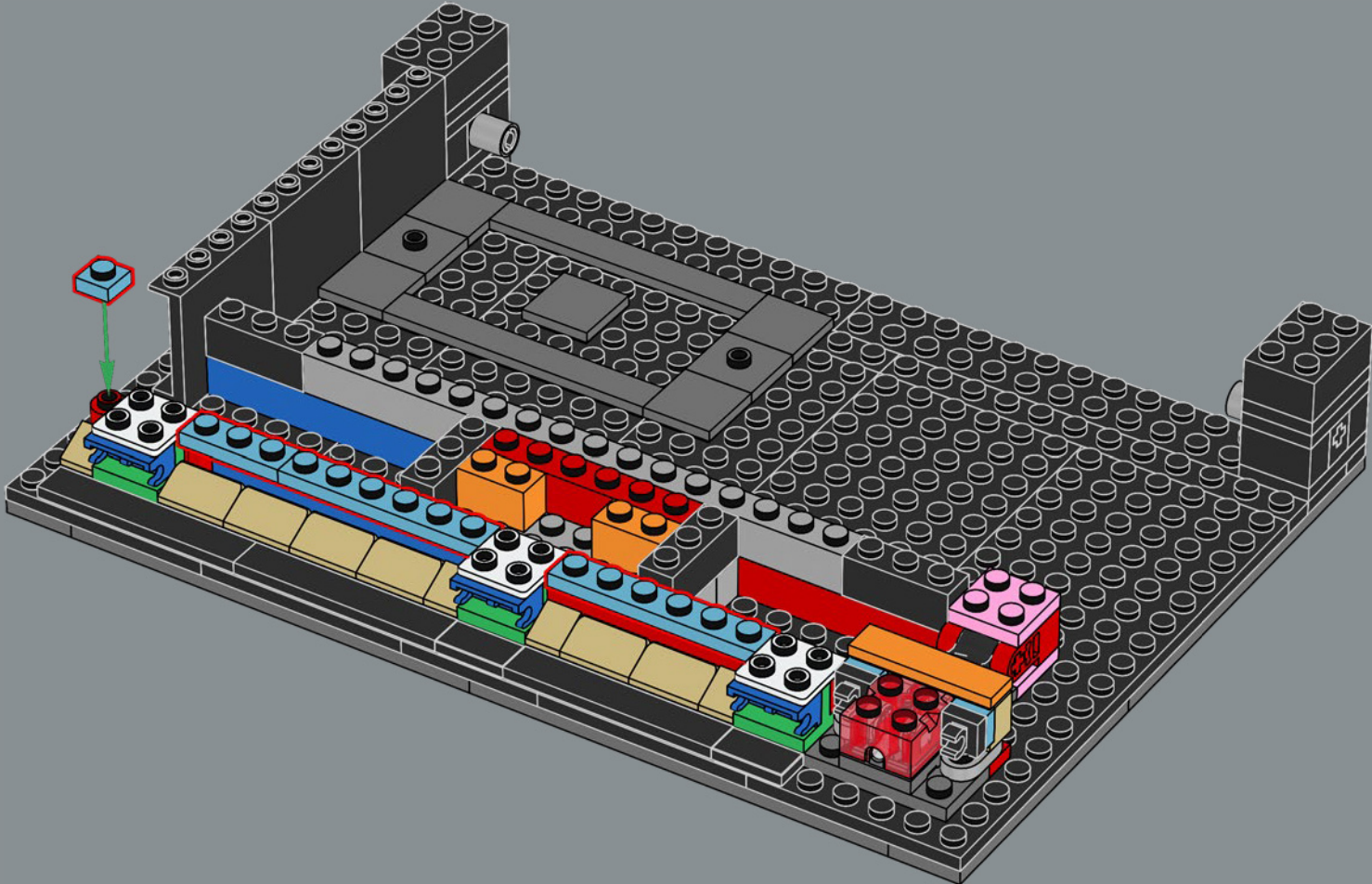



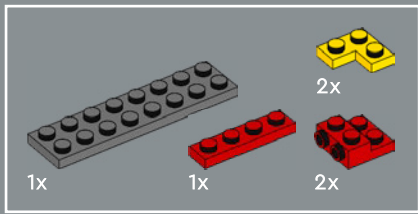

22

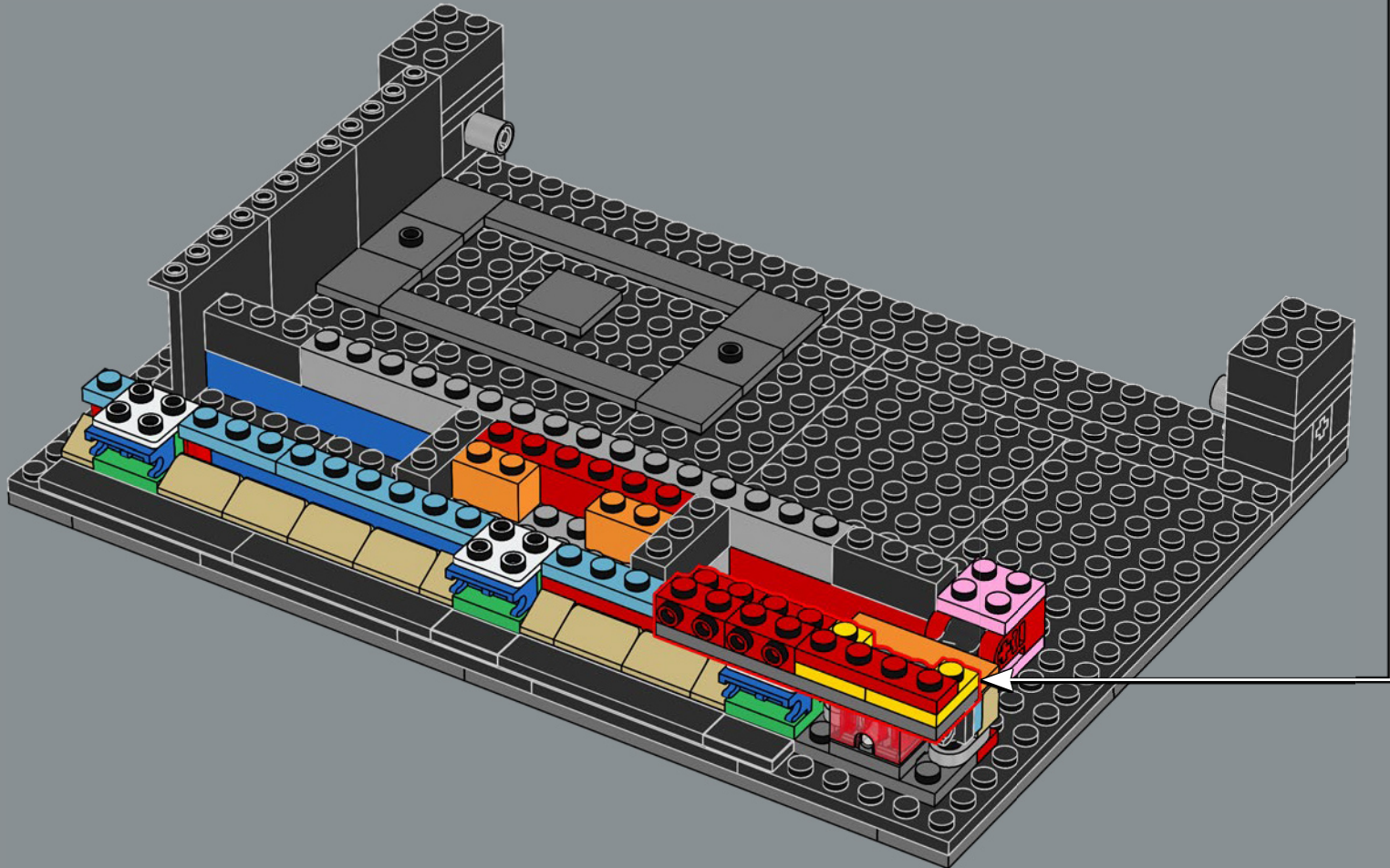
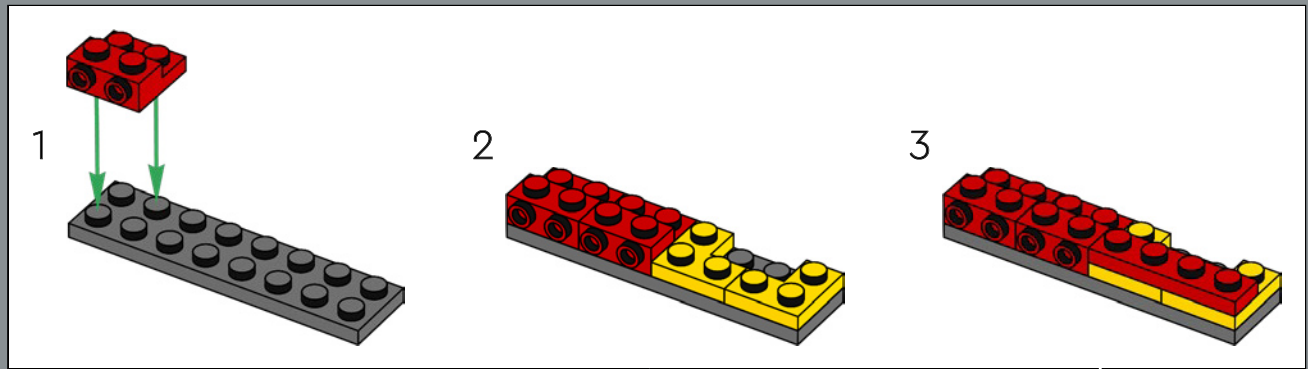

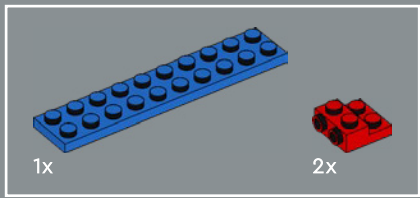

23

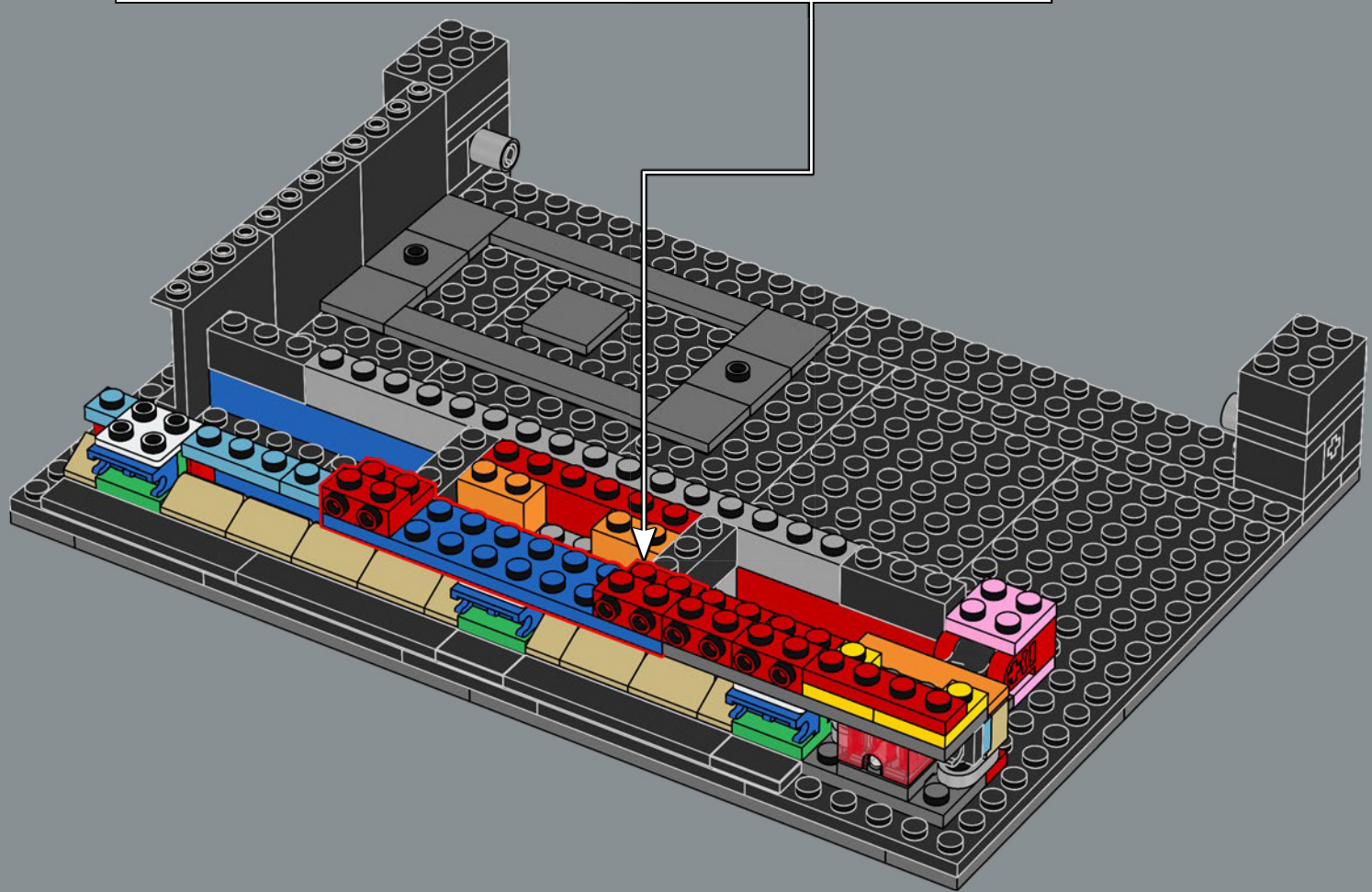
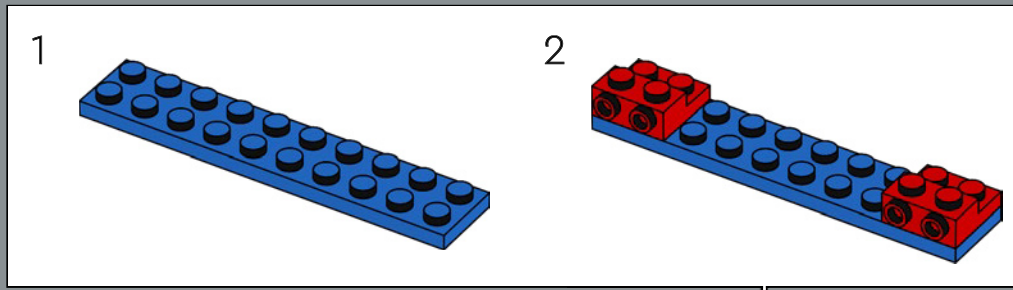

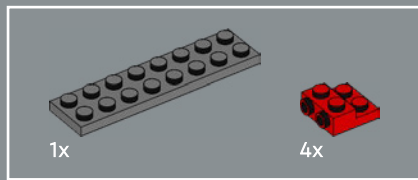

24

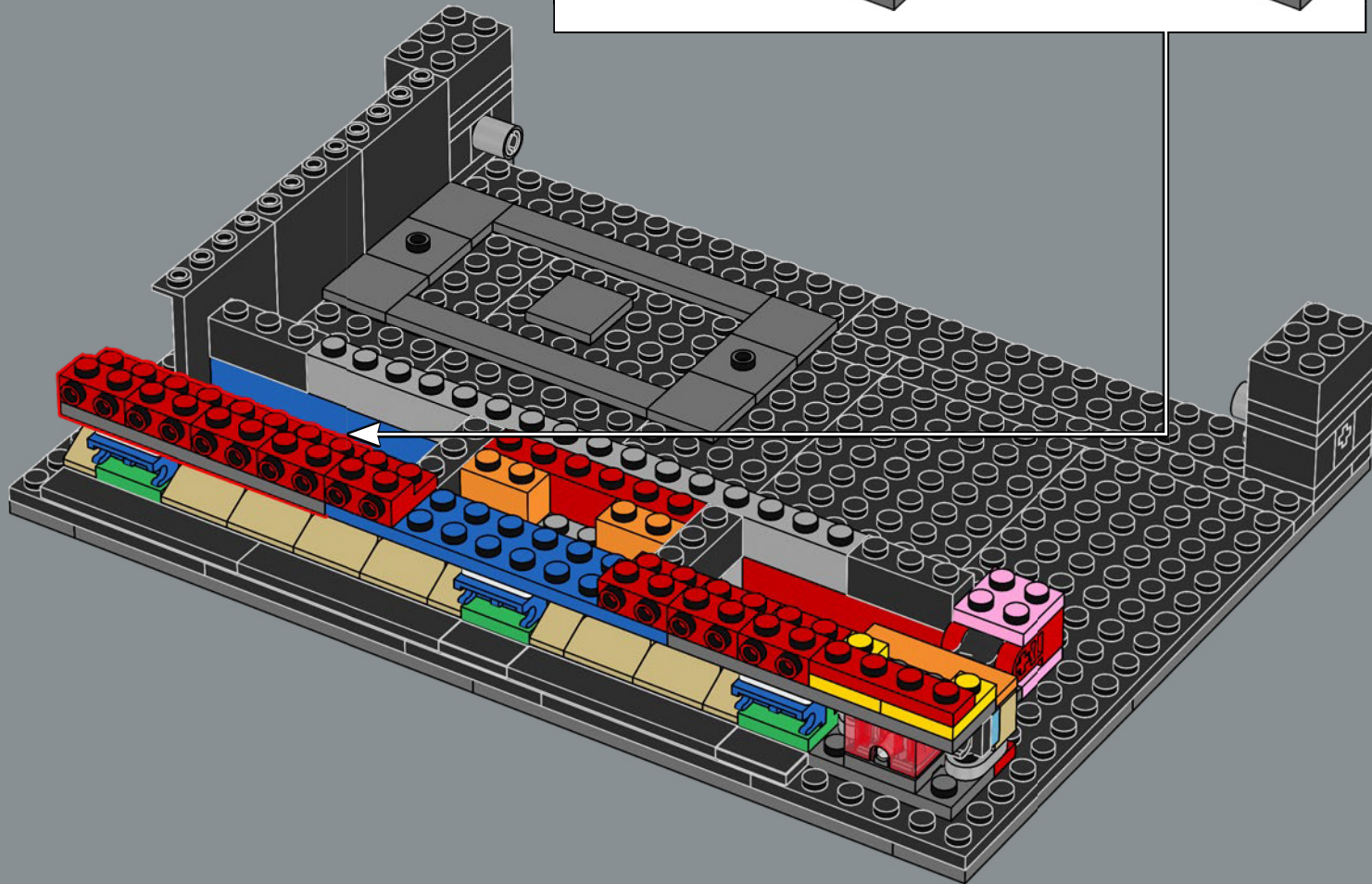
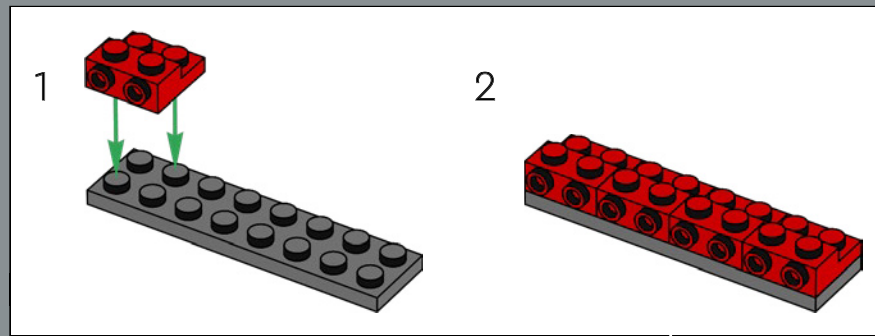

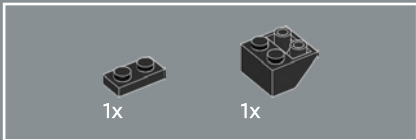
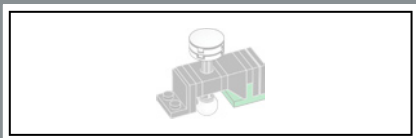

25

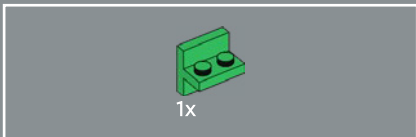
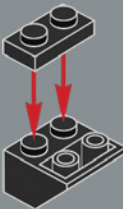

26

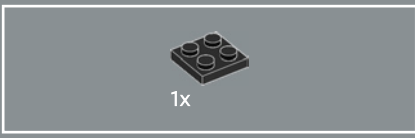

27

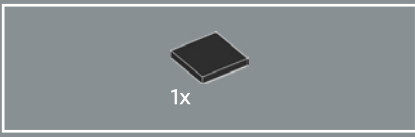
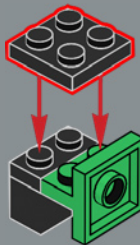

28

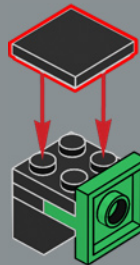

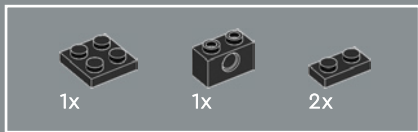

29

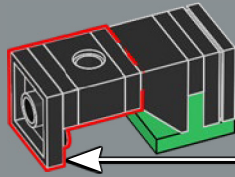
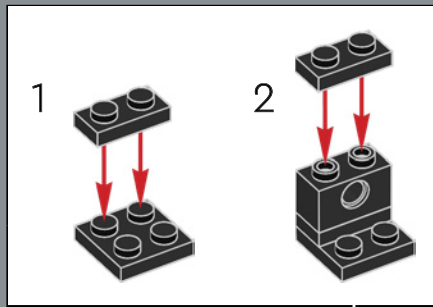

30

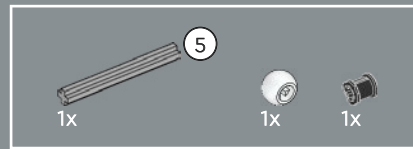
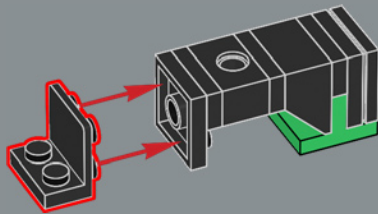

31

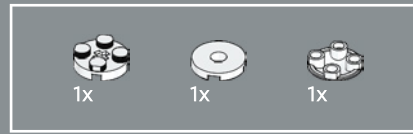
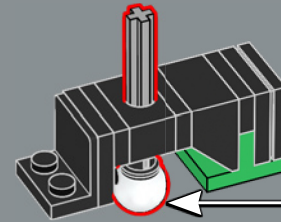
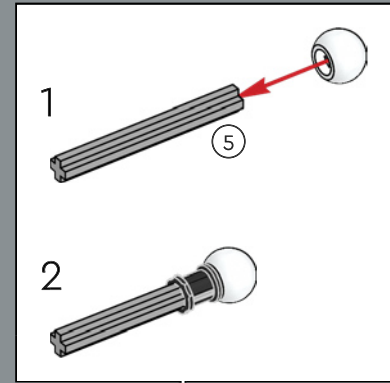

32

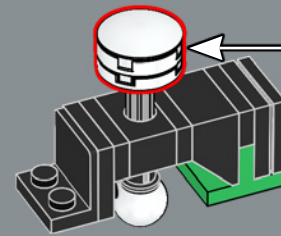
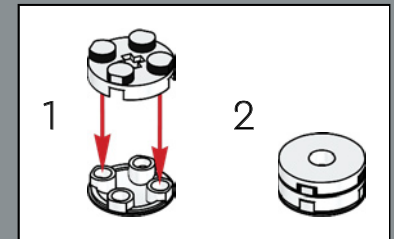

33

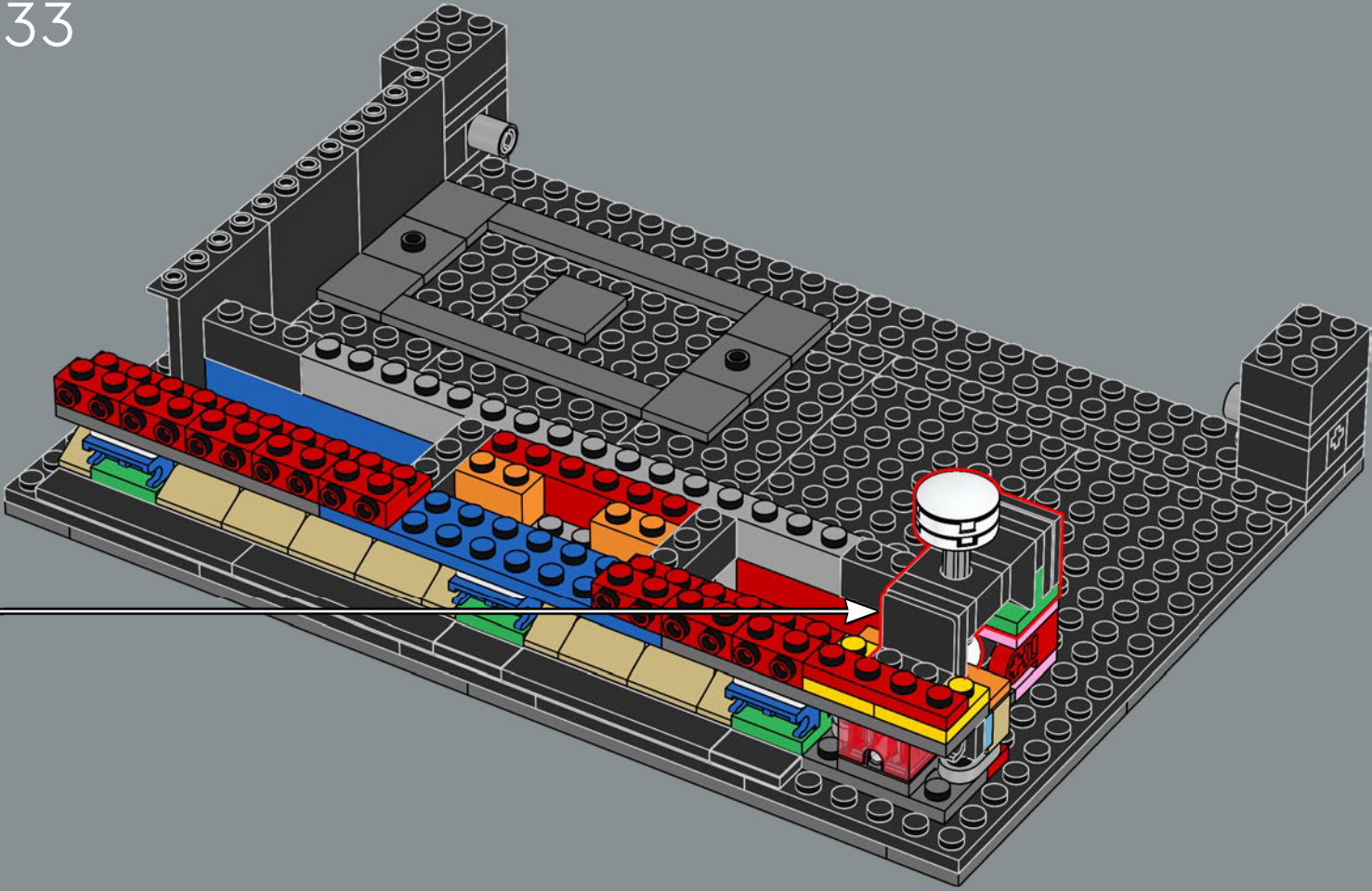

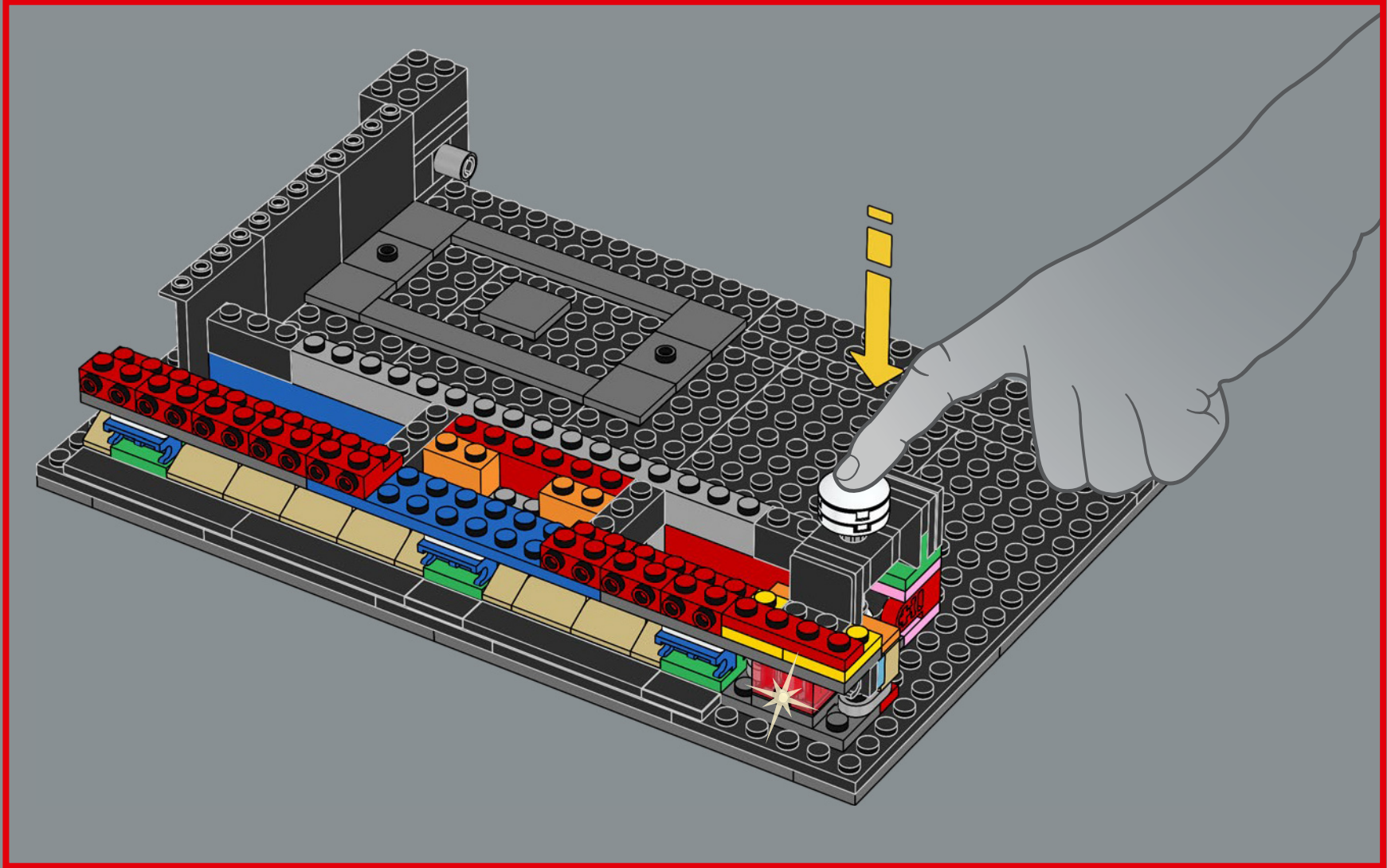

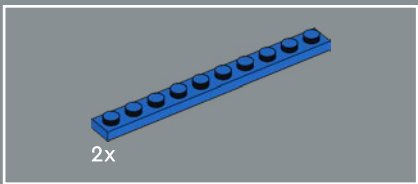

34

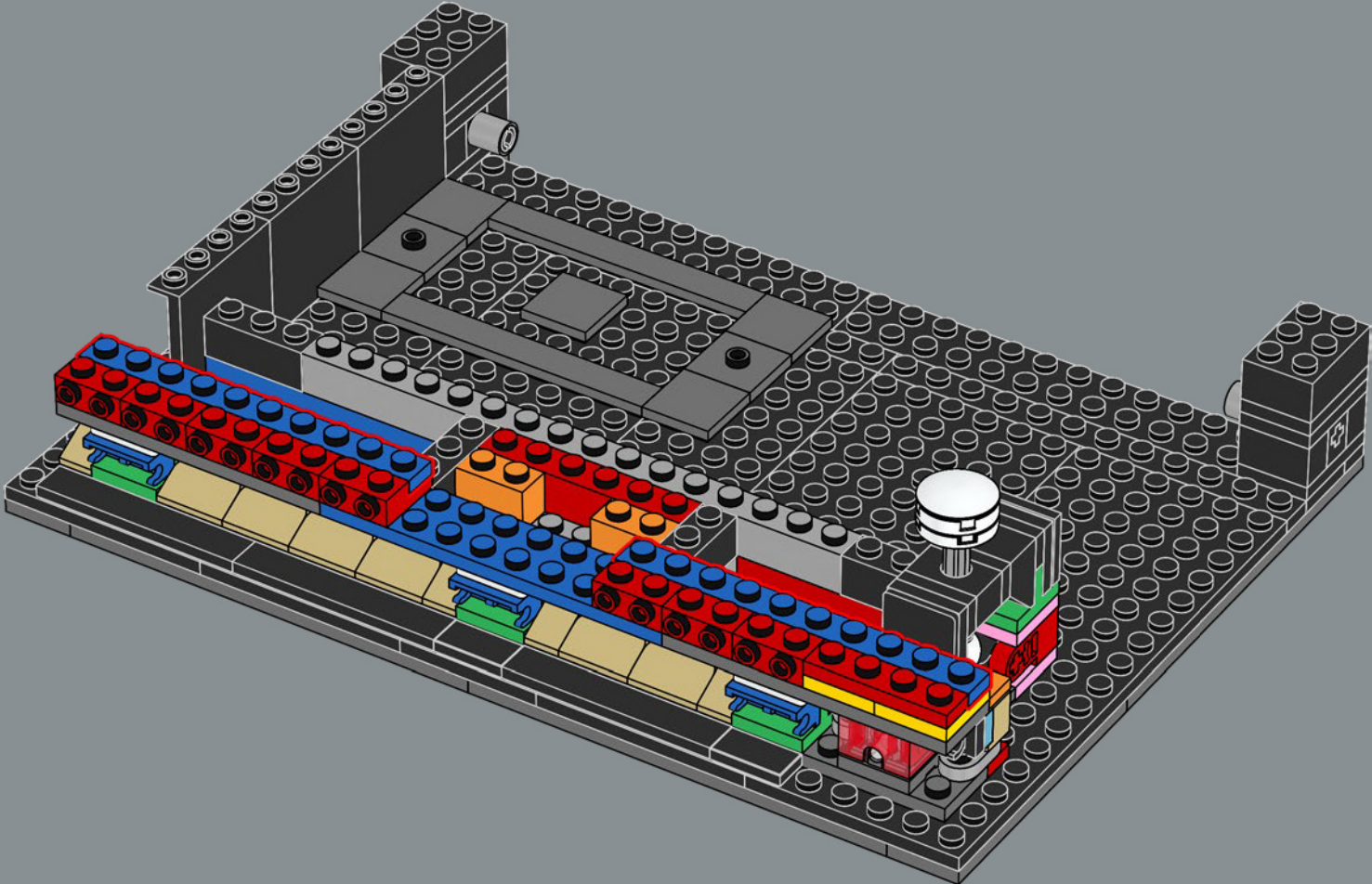



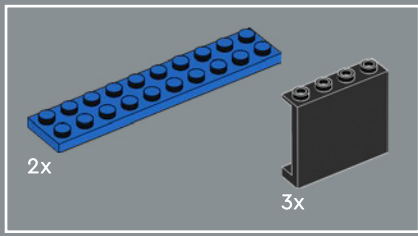

35

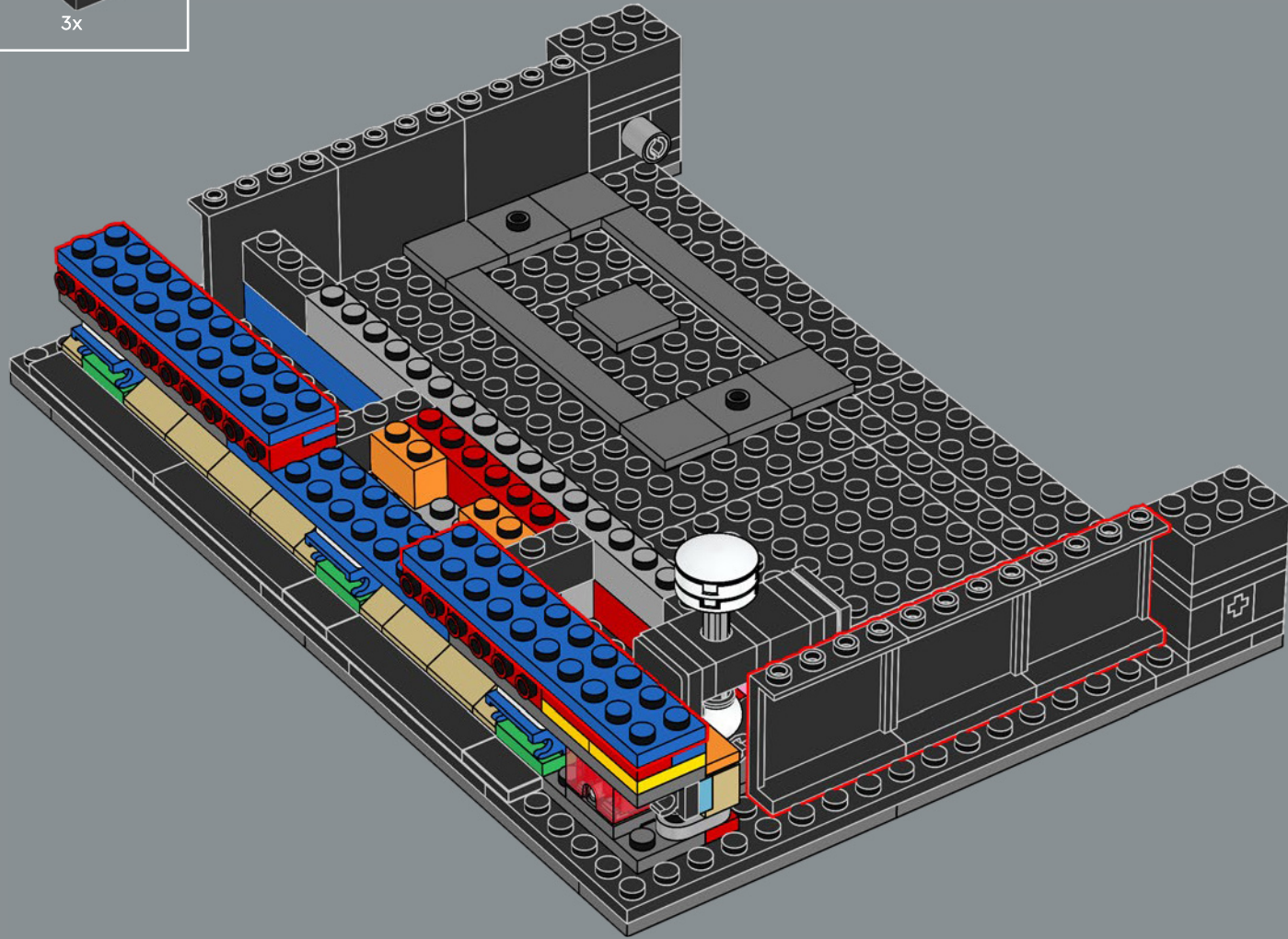

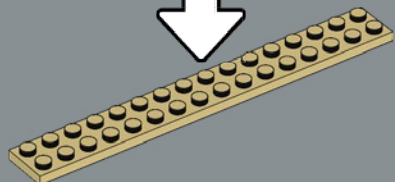

1x

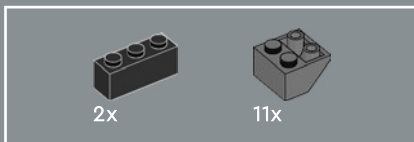

2x

11x

36

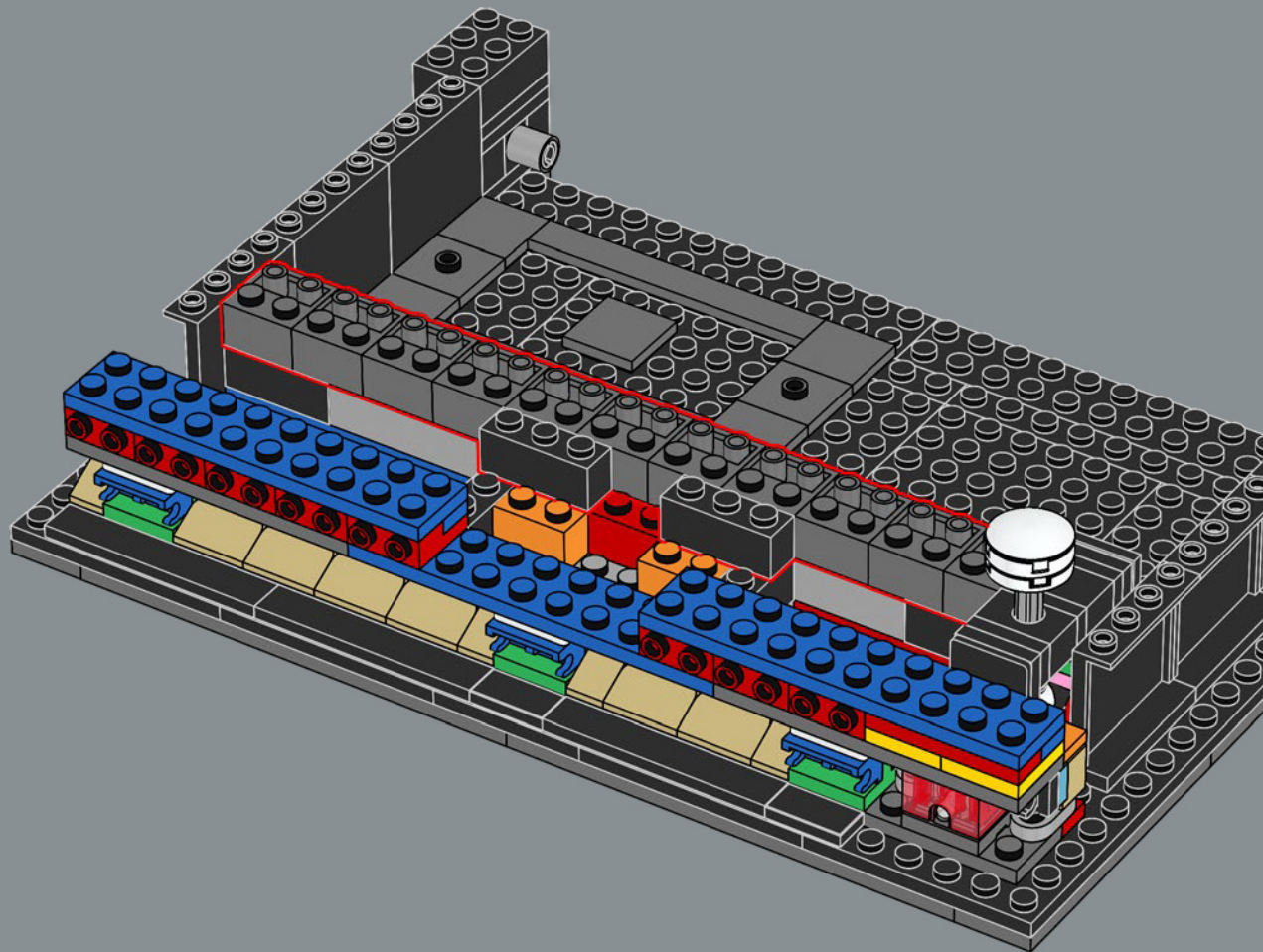

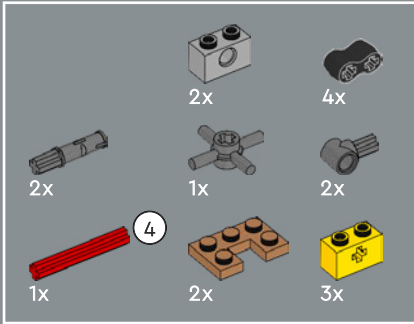
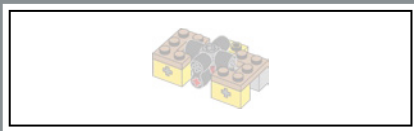

37

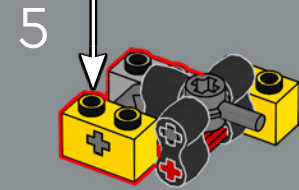
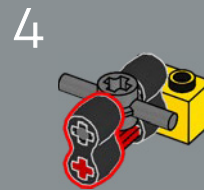
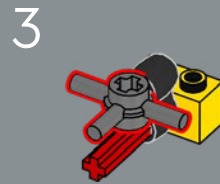
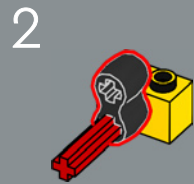
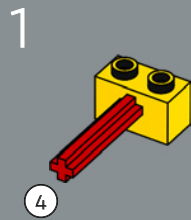
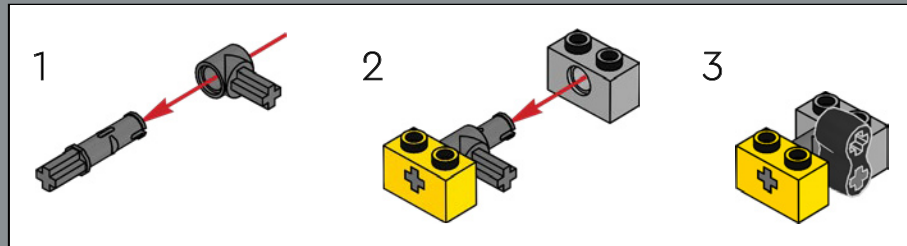

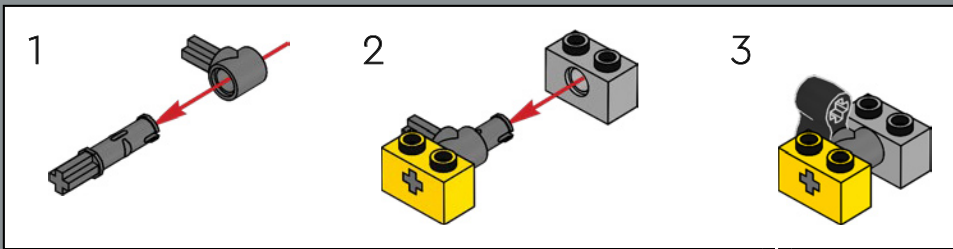

6

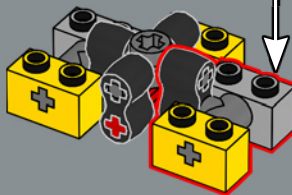

7

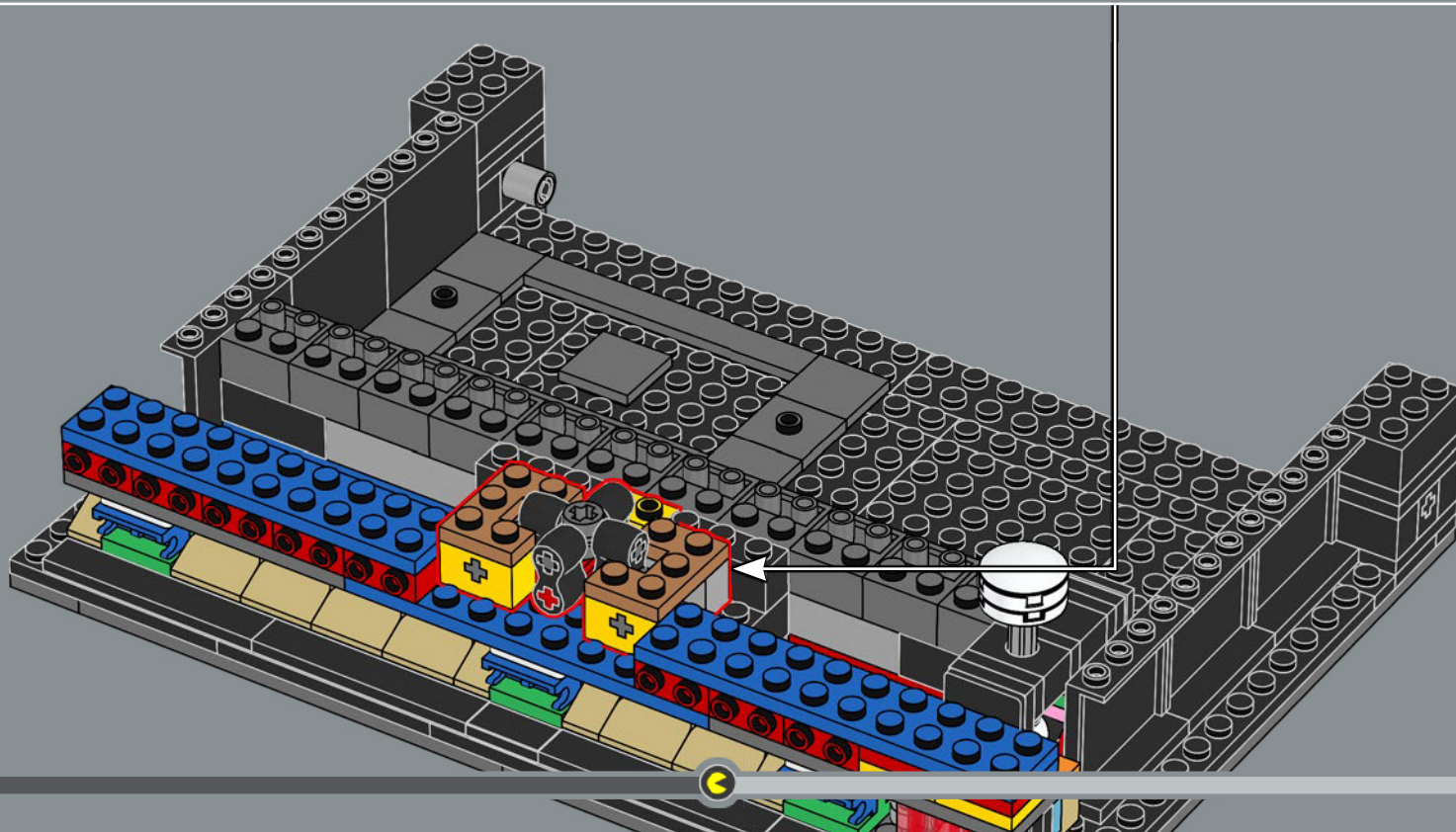
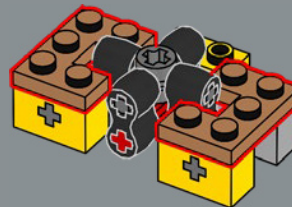

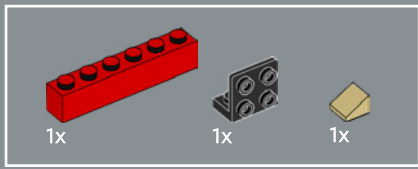

38

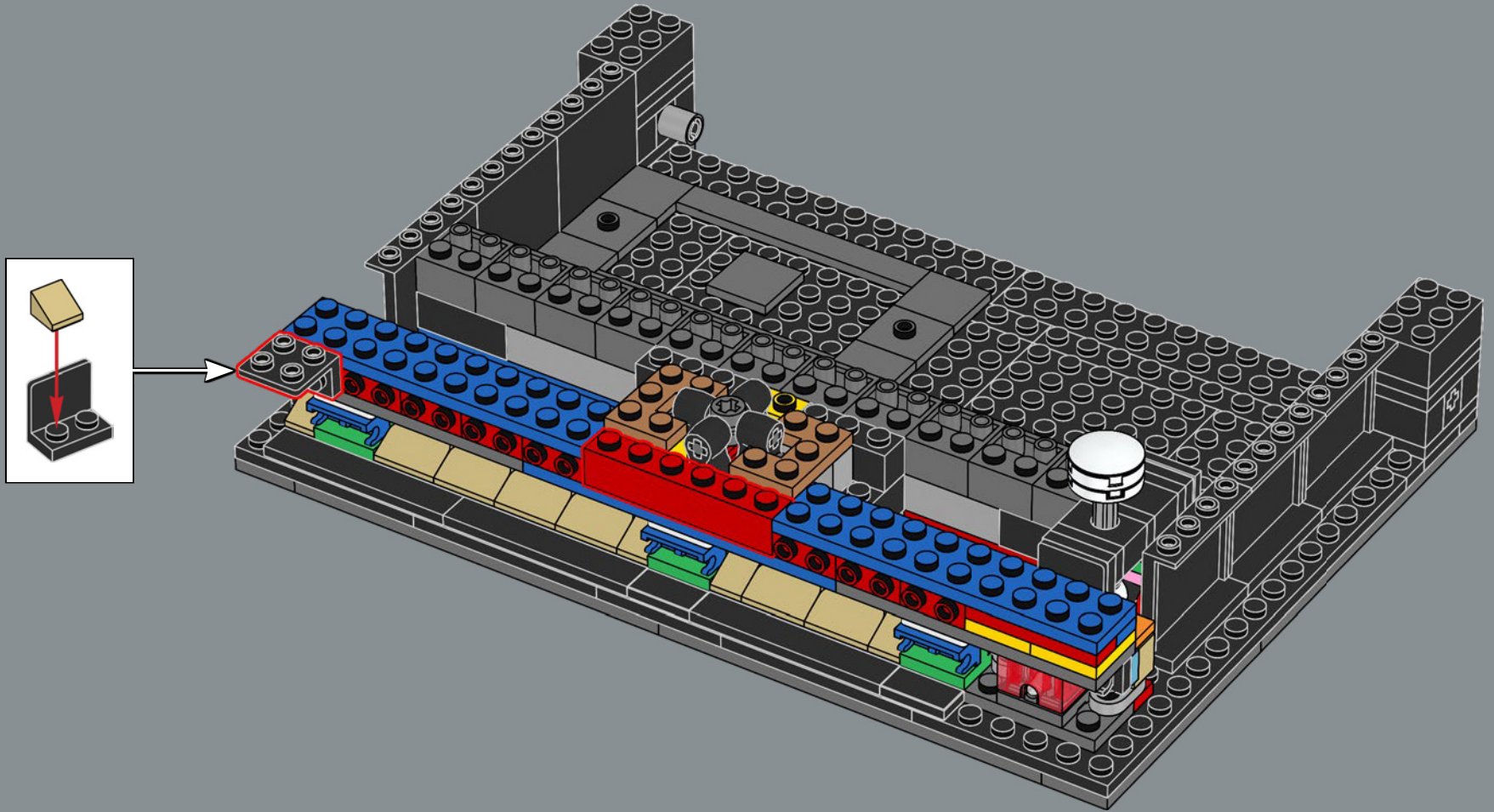



39

1

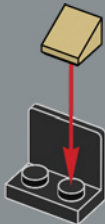

2

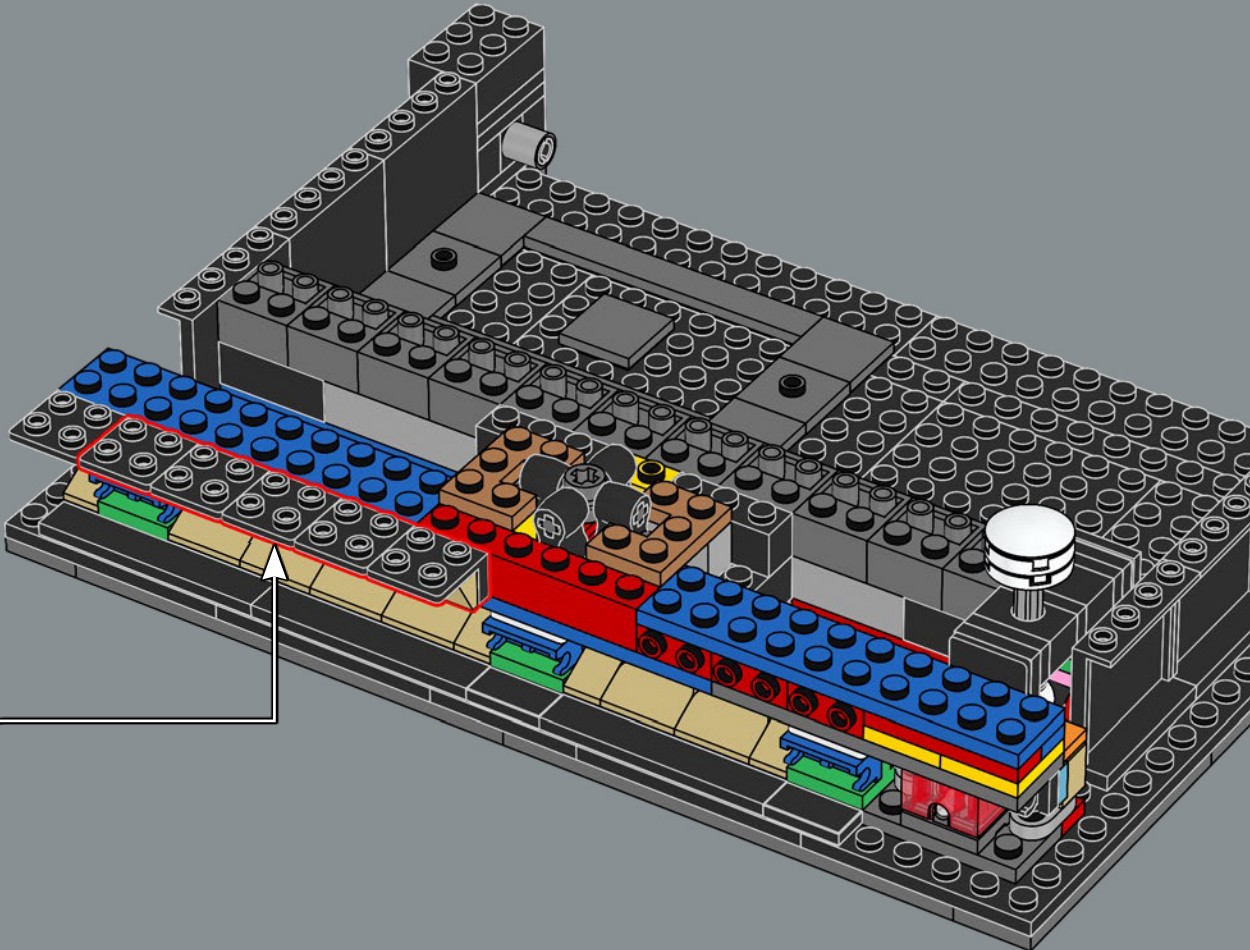
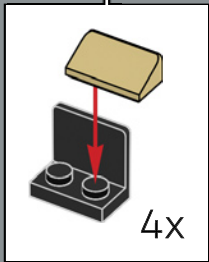
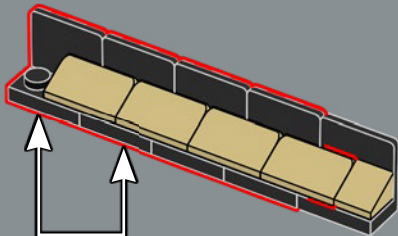



40

1

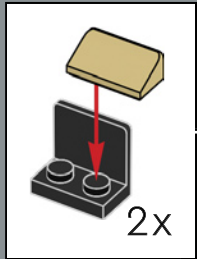
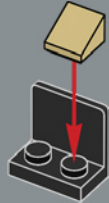

2

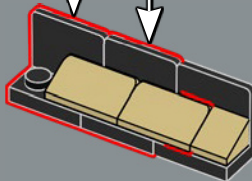

3

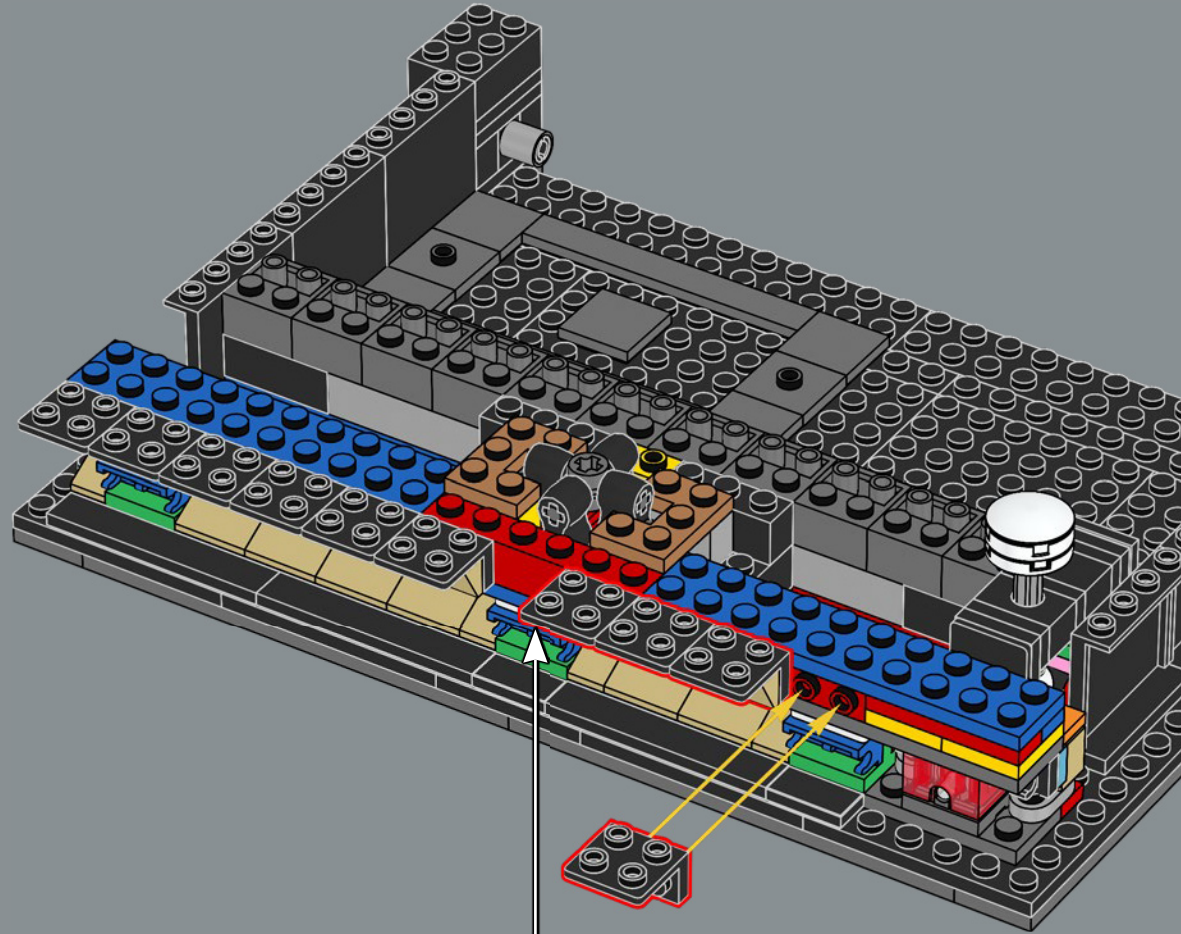
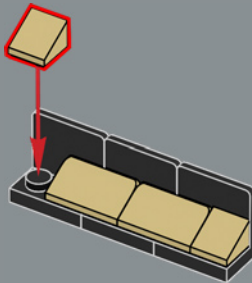

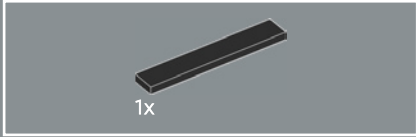
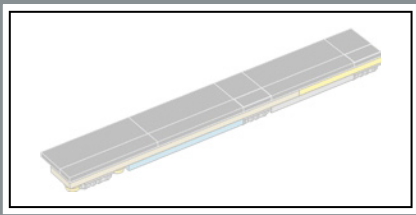

41

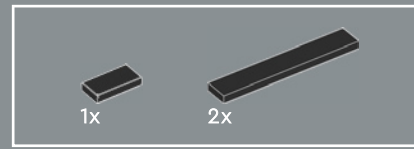
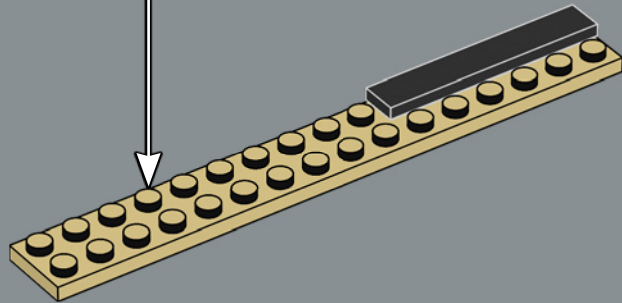
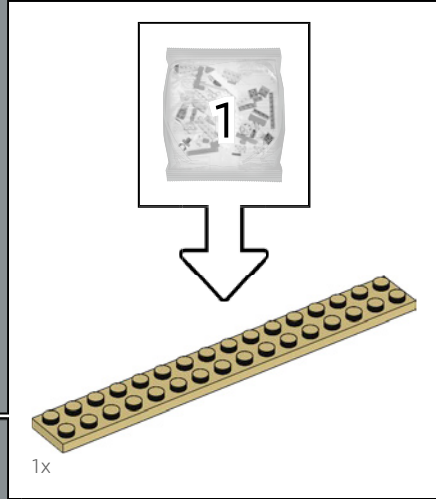

42

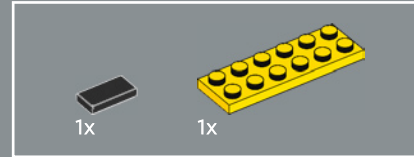
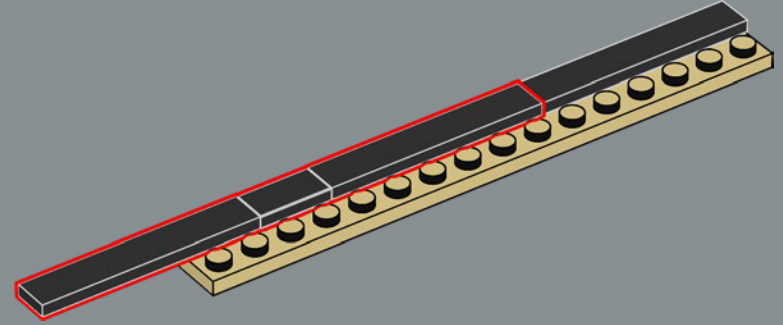

43

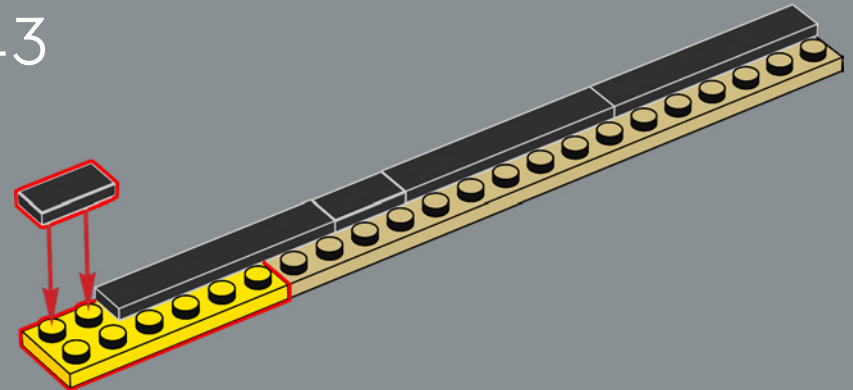



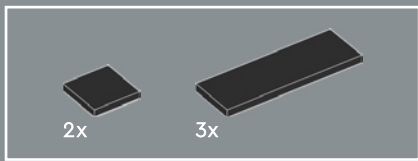

44

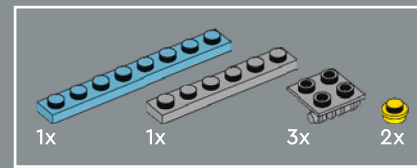
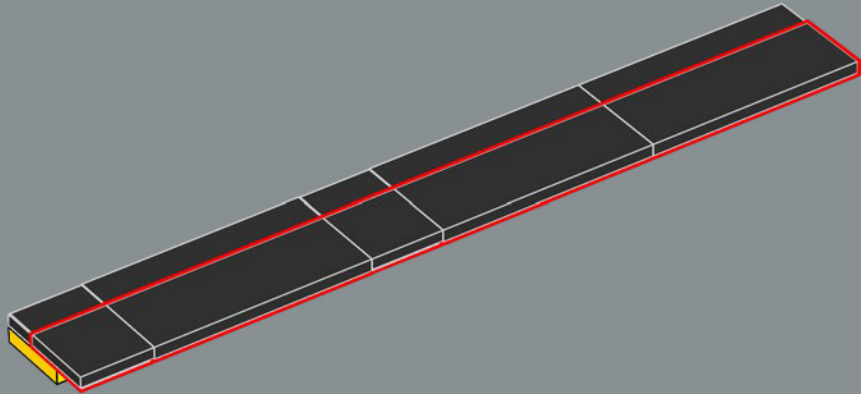

45

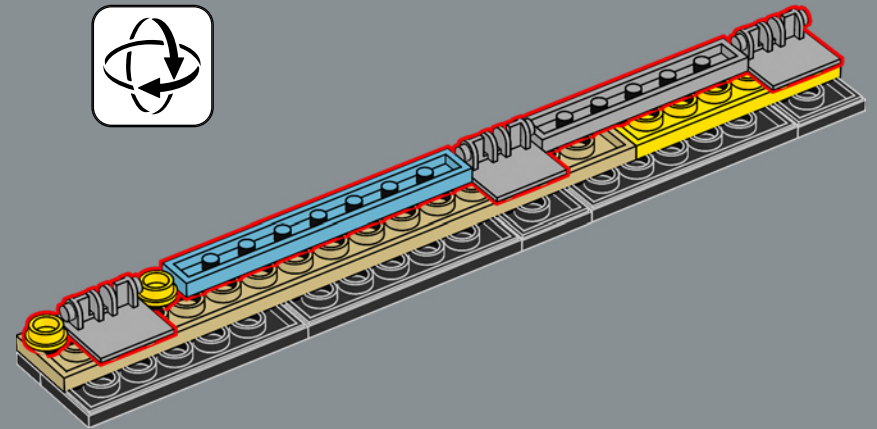

46

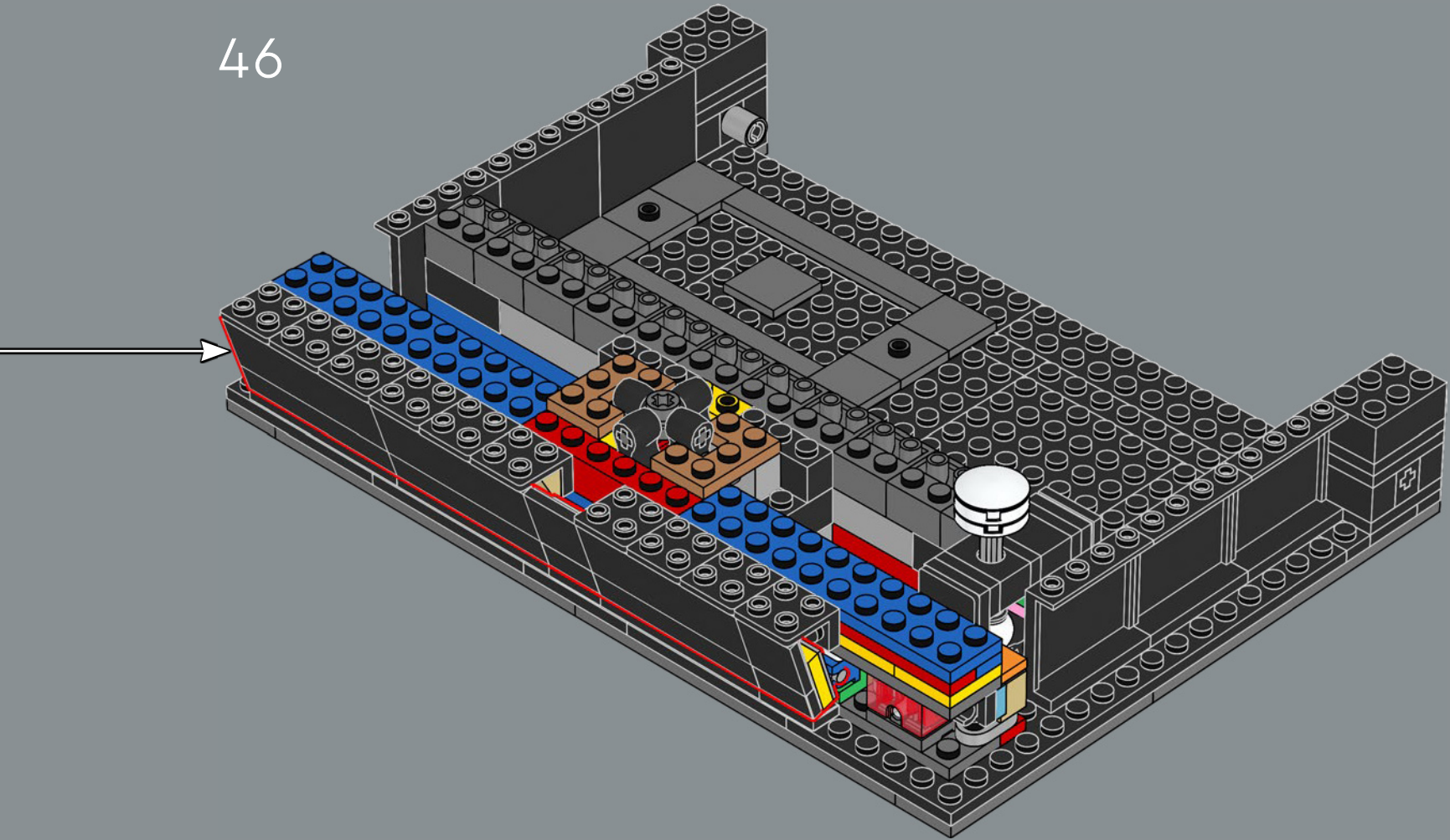

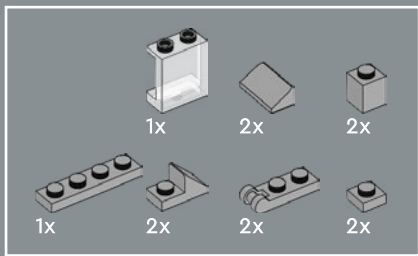

47

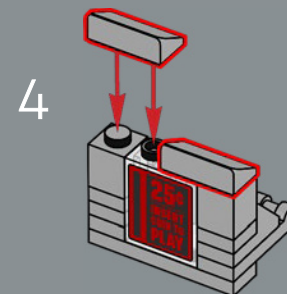
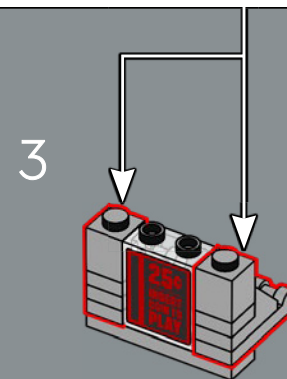
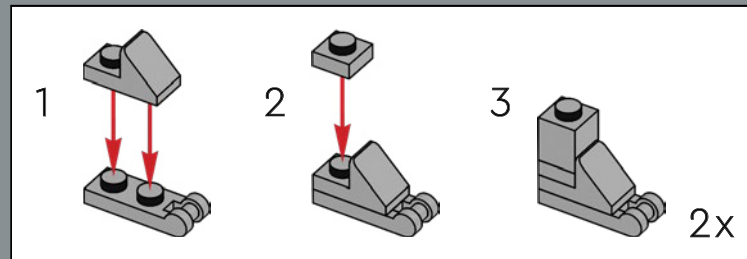
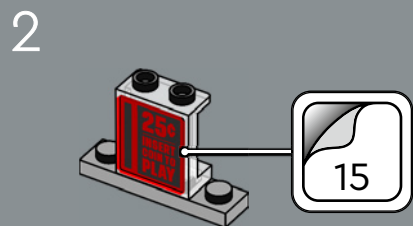
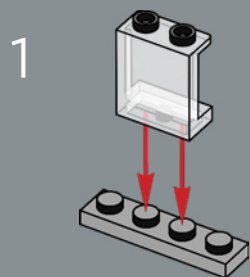

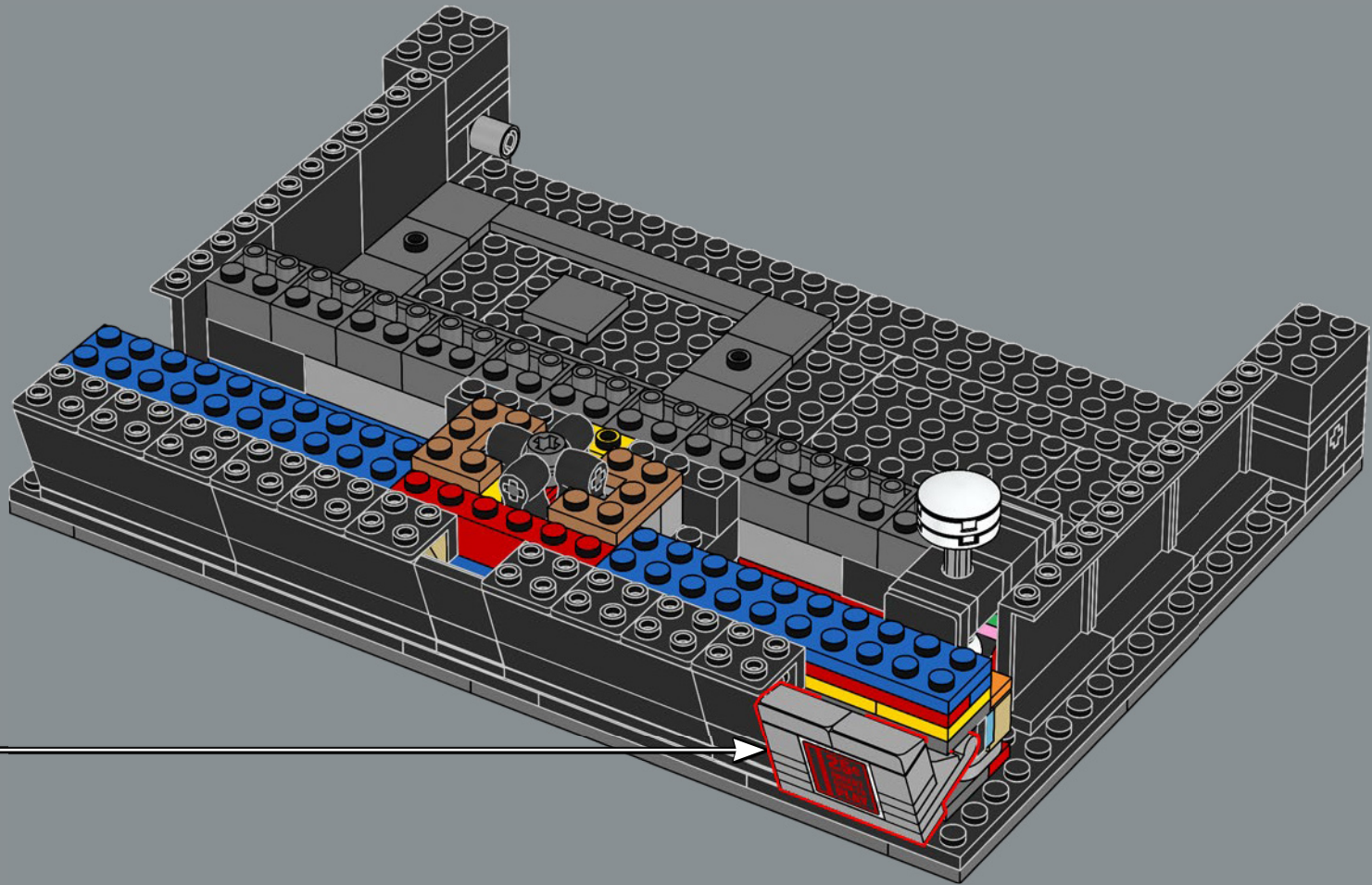

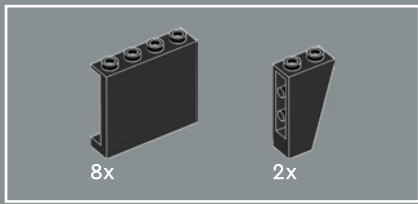

48

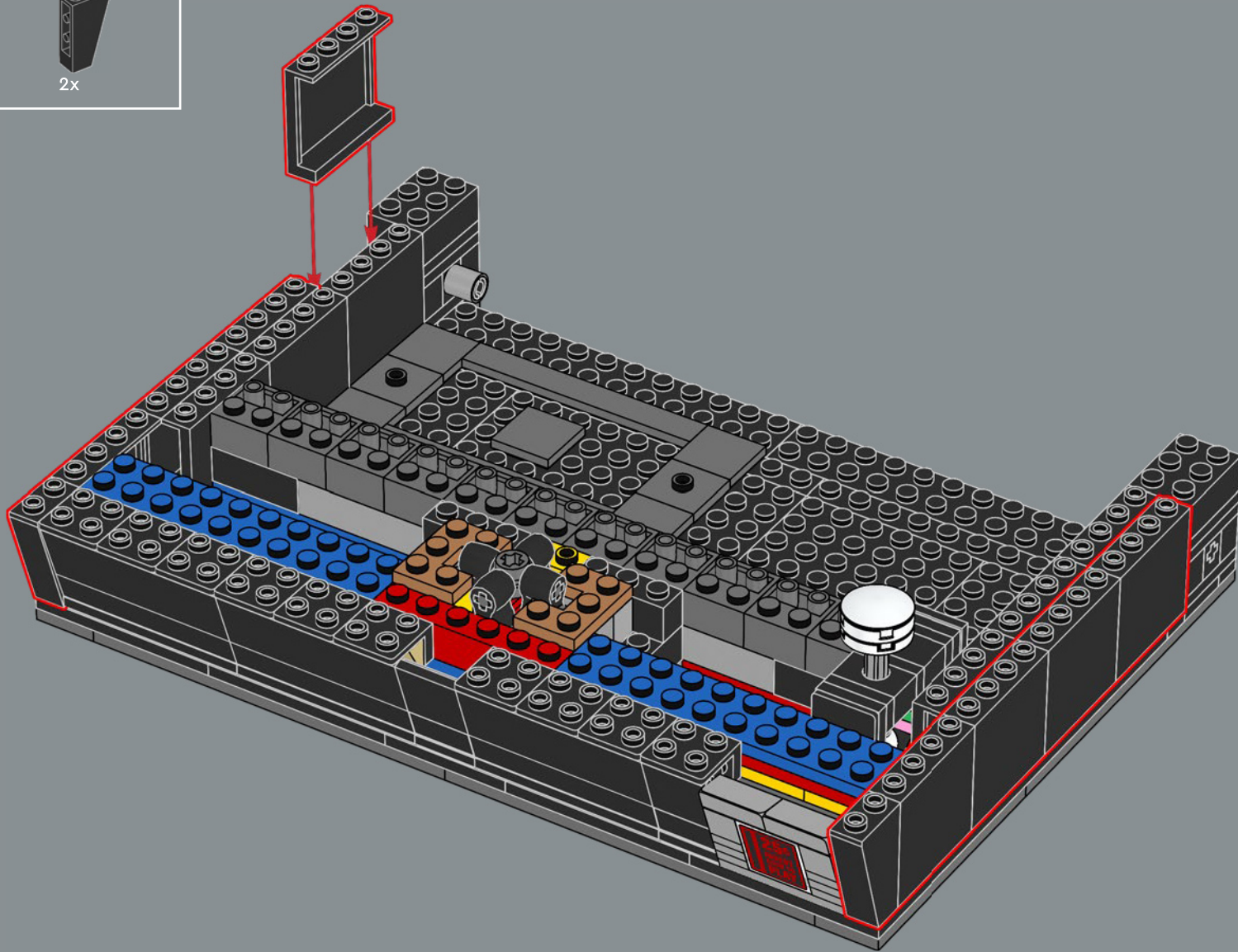

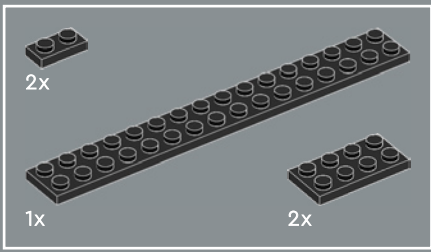

49

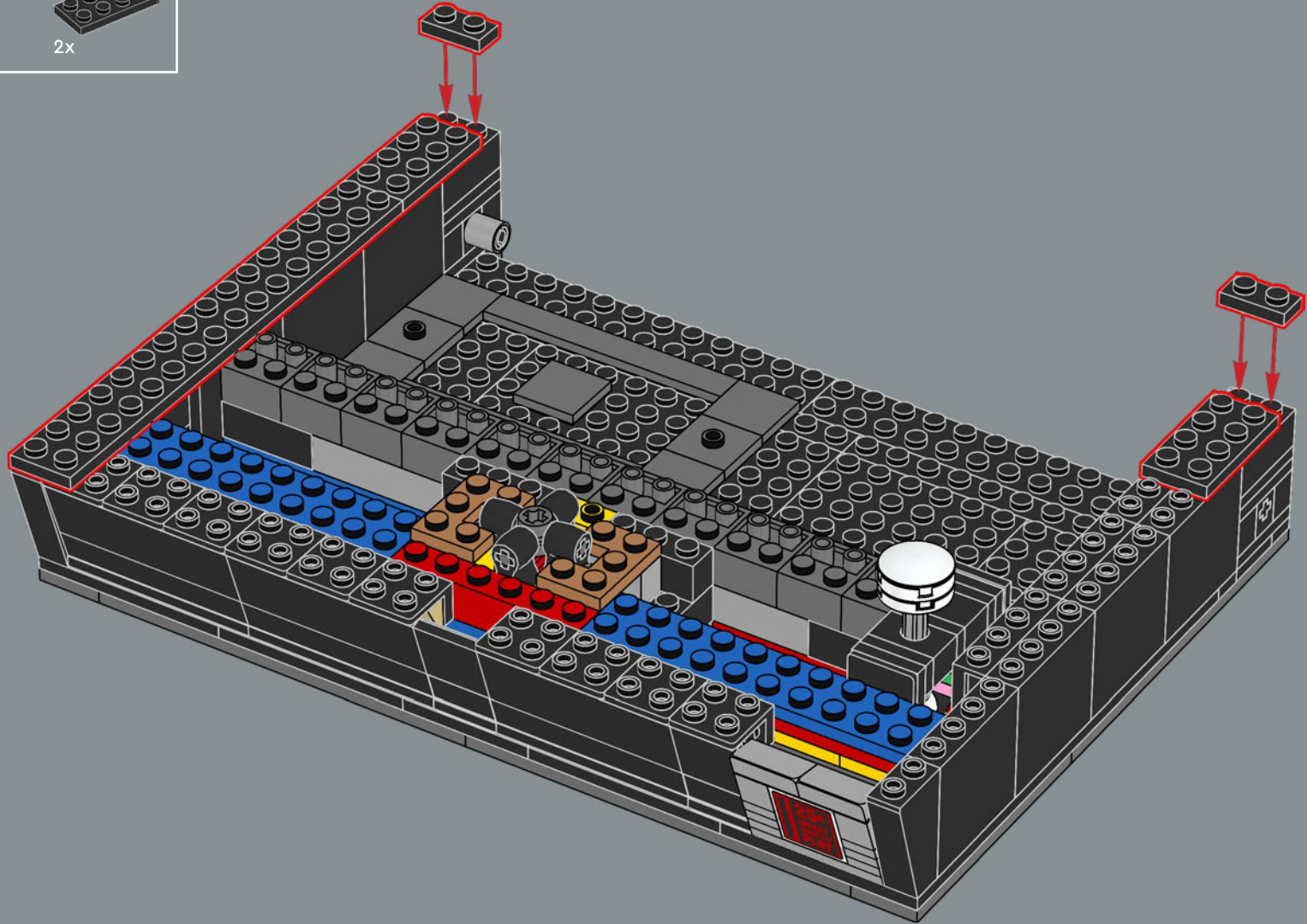

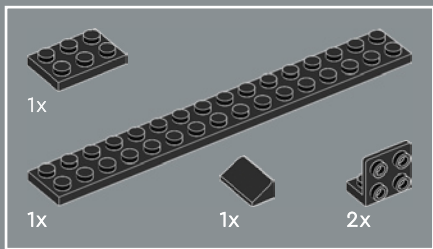

50

1

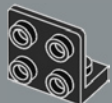

2

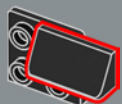

3

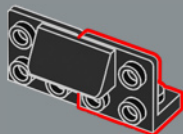

4

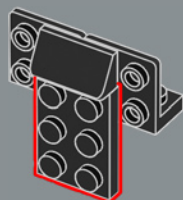

5

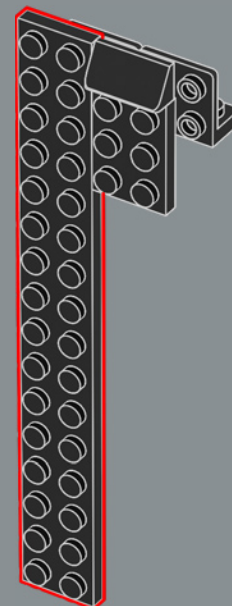

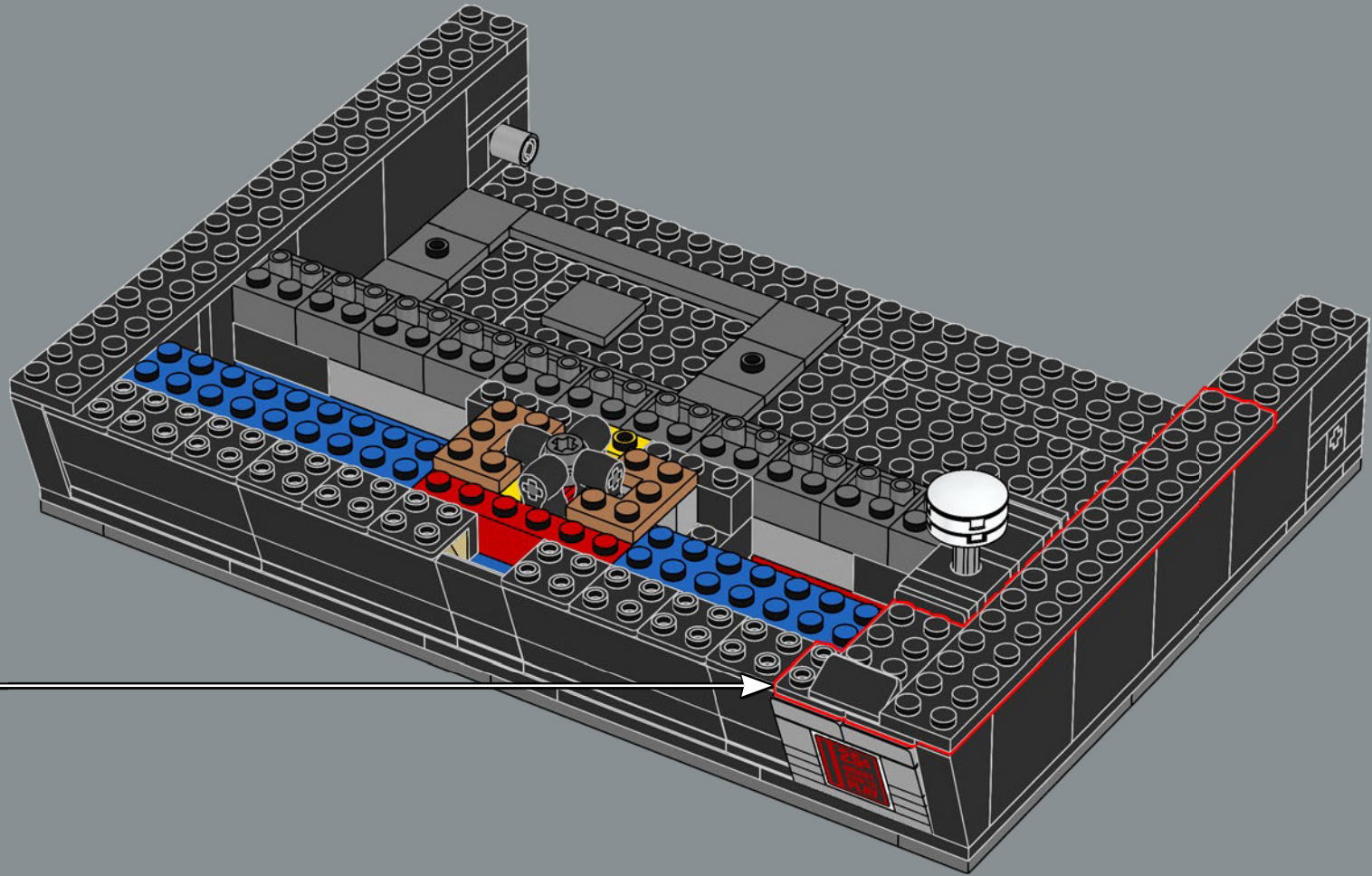



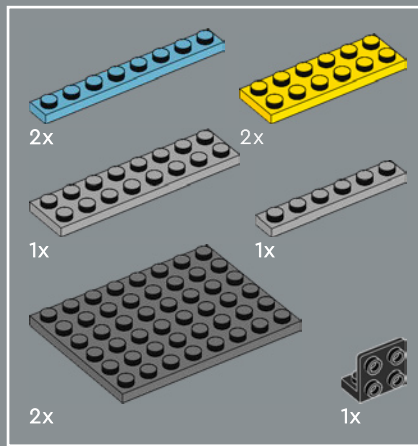

51

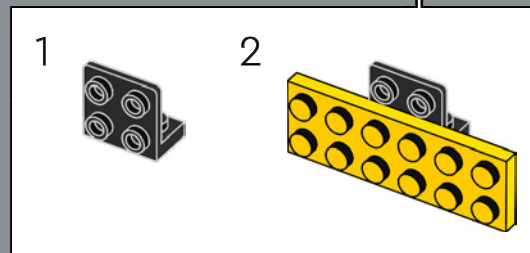
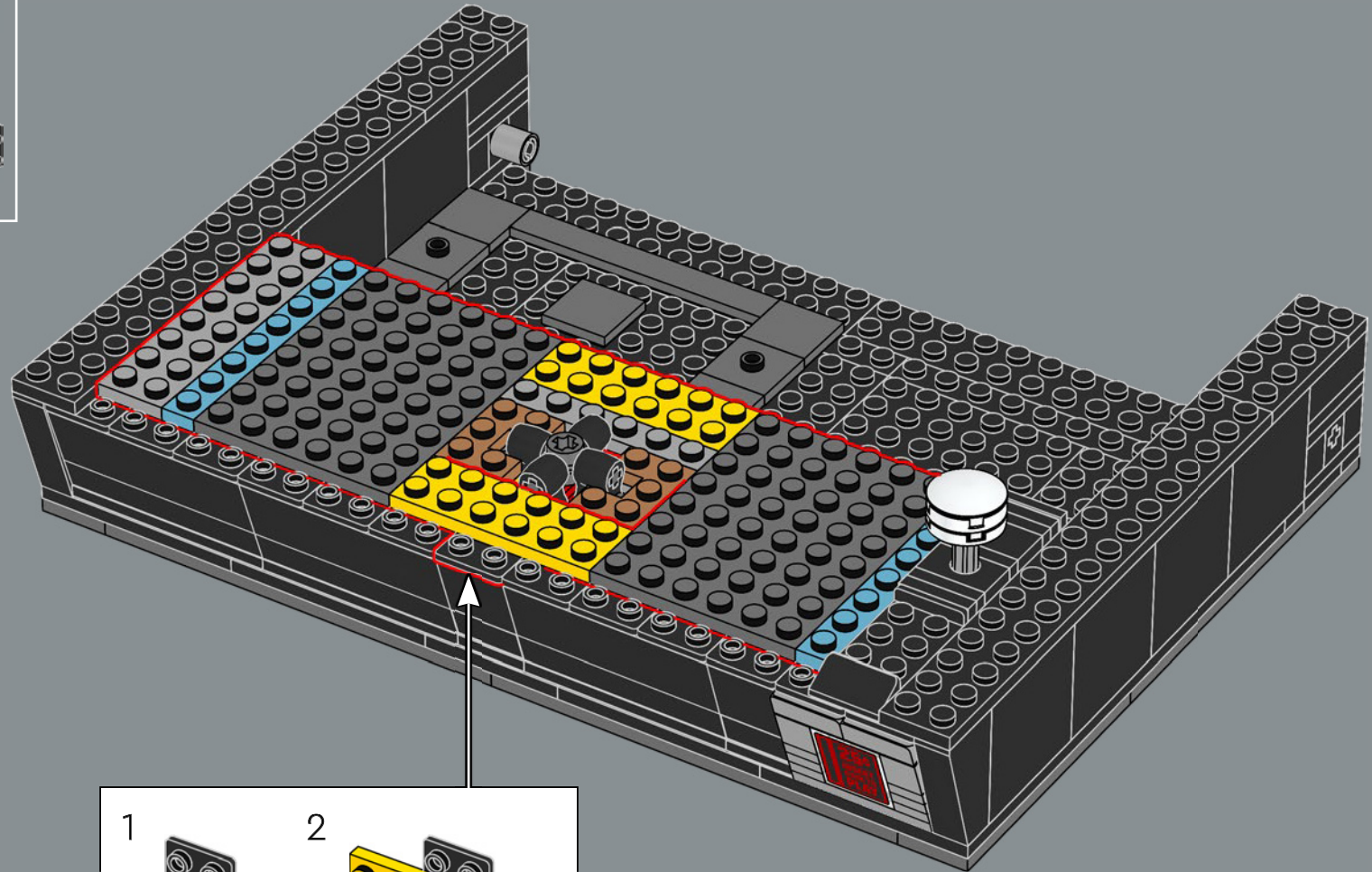

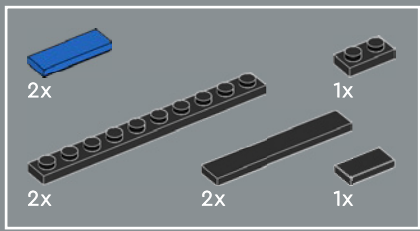

52

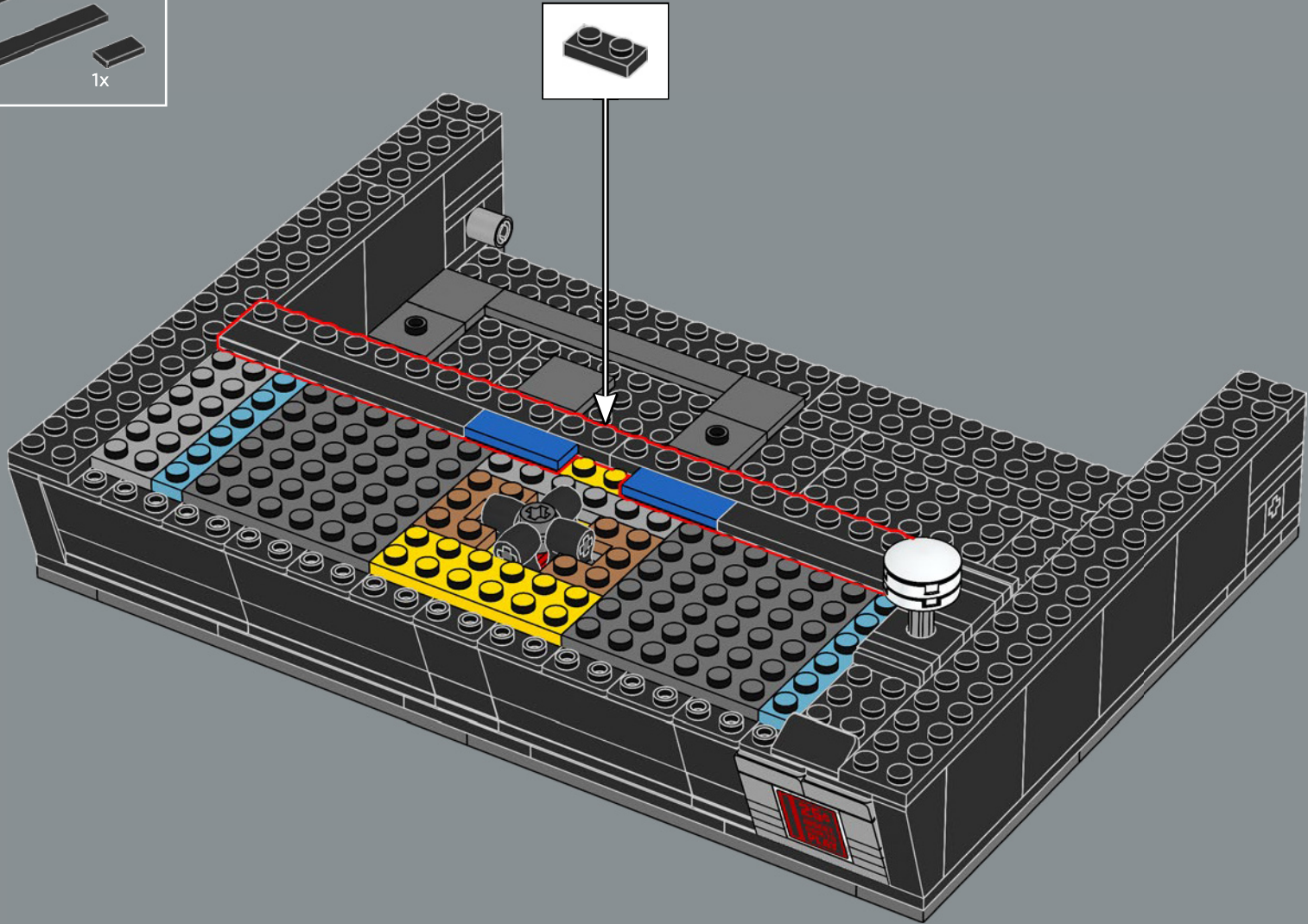

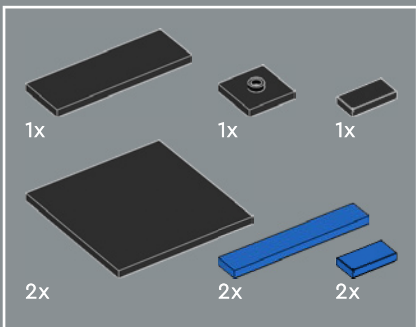

53

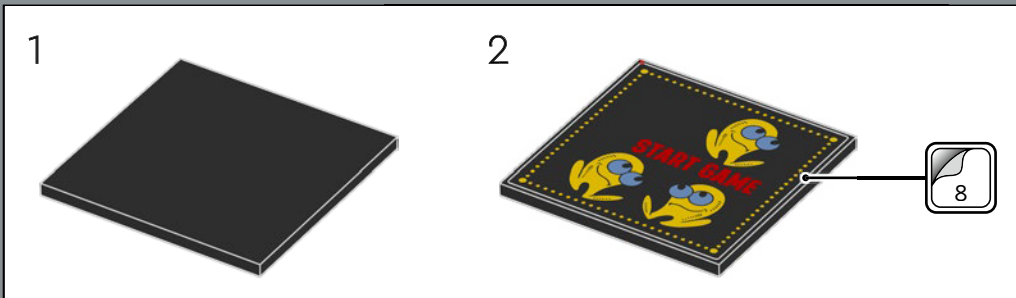
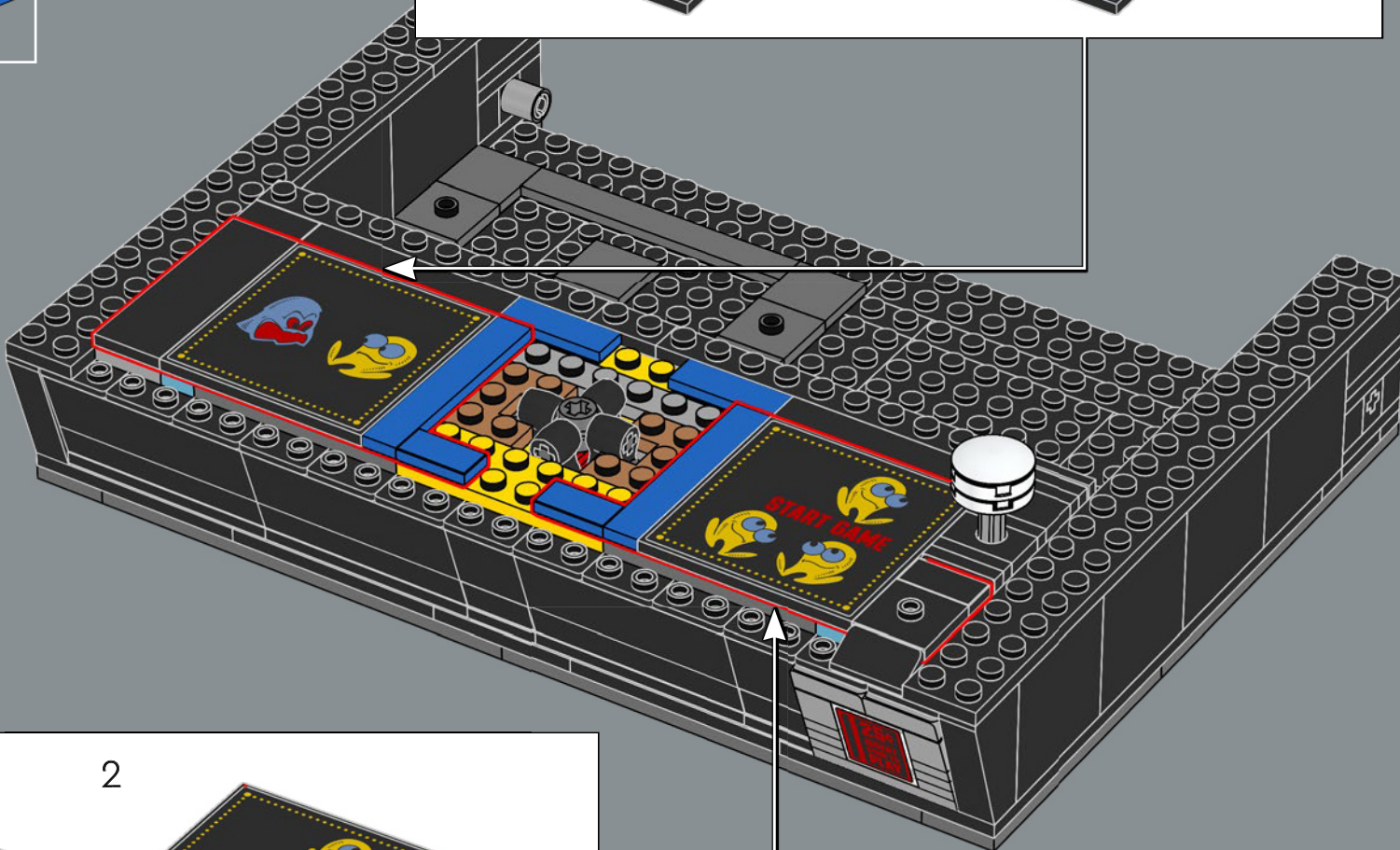
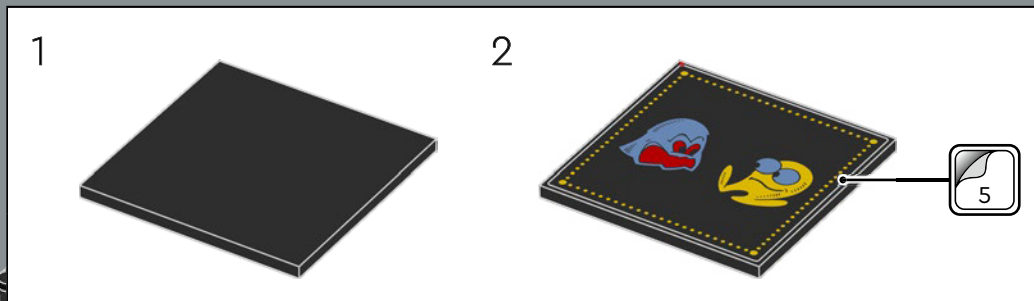

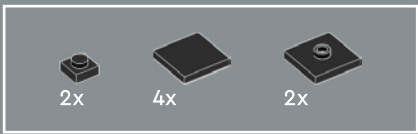

54

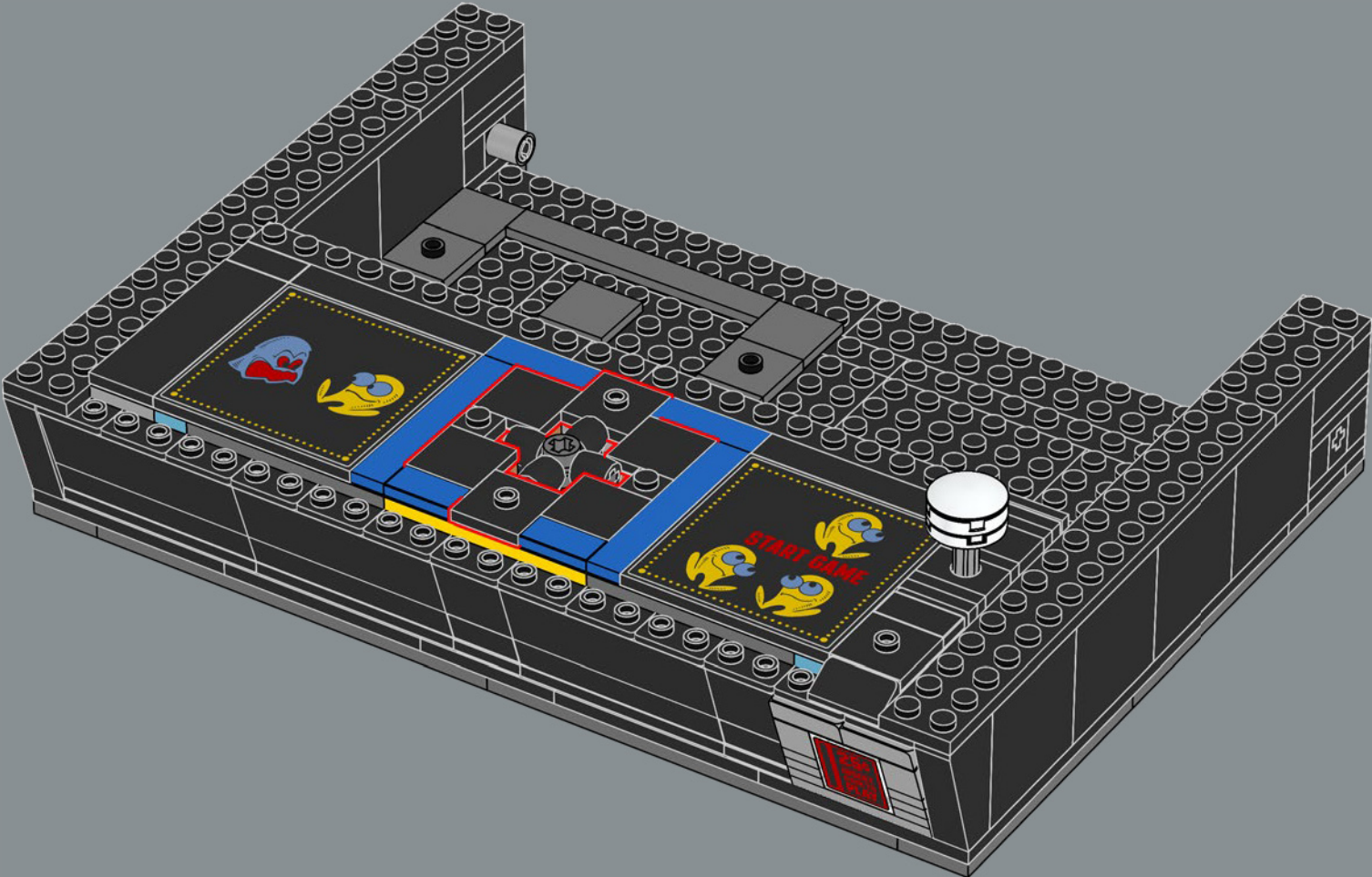



55

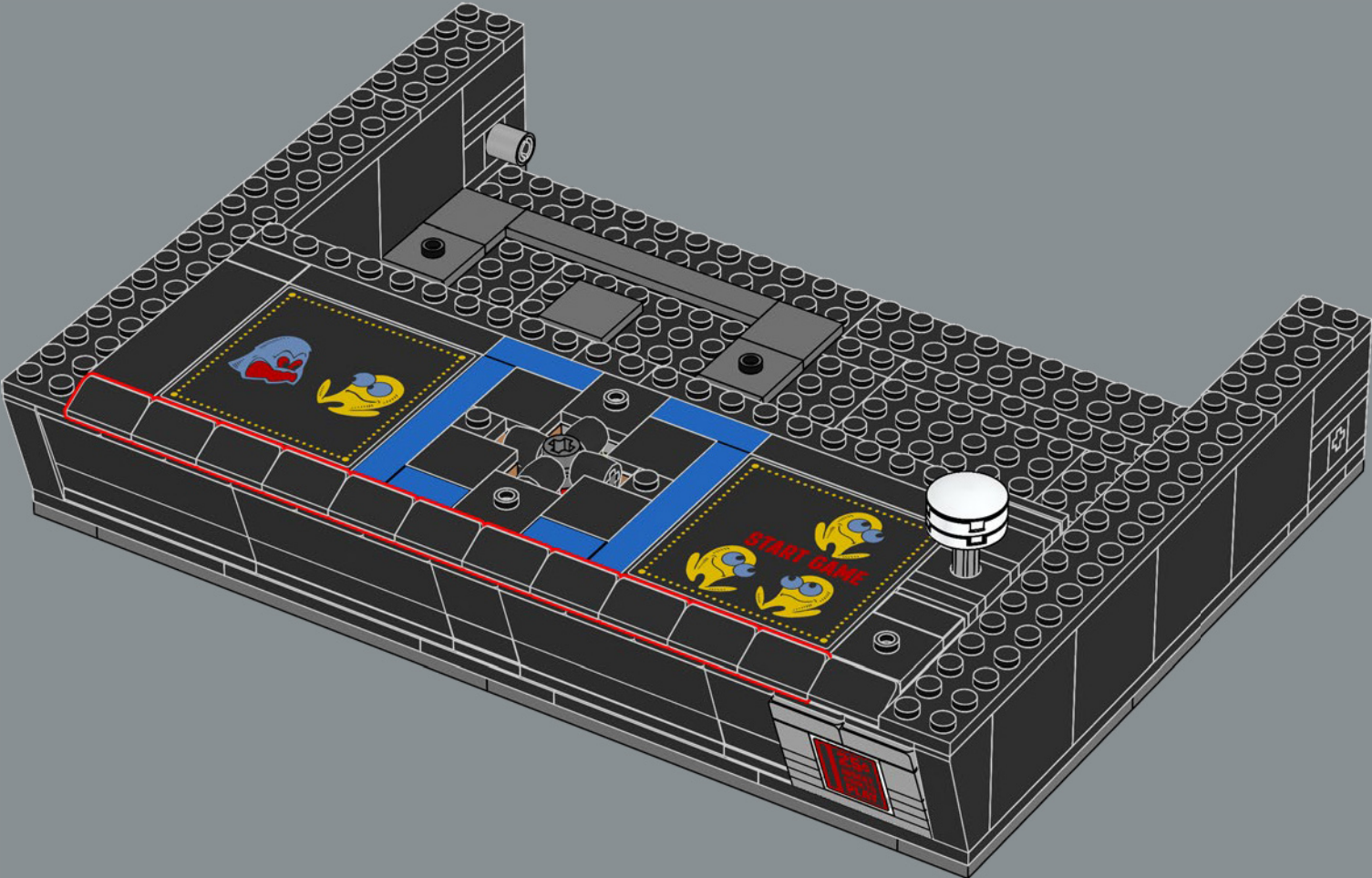



56

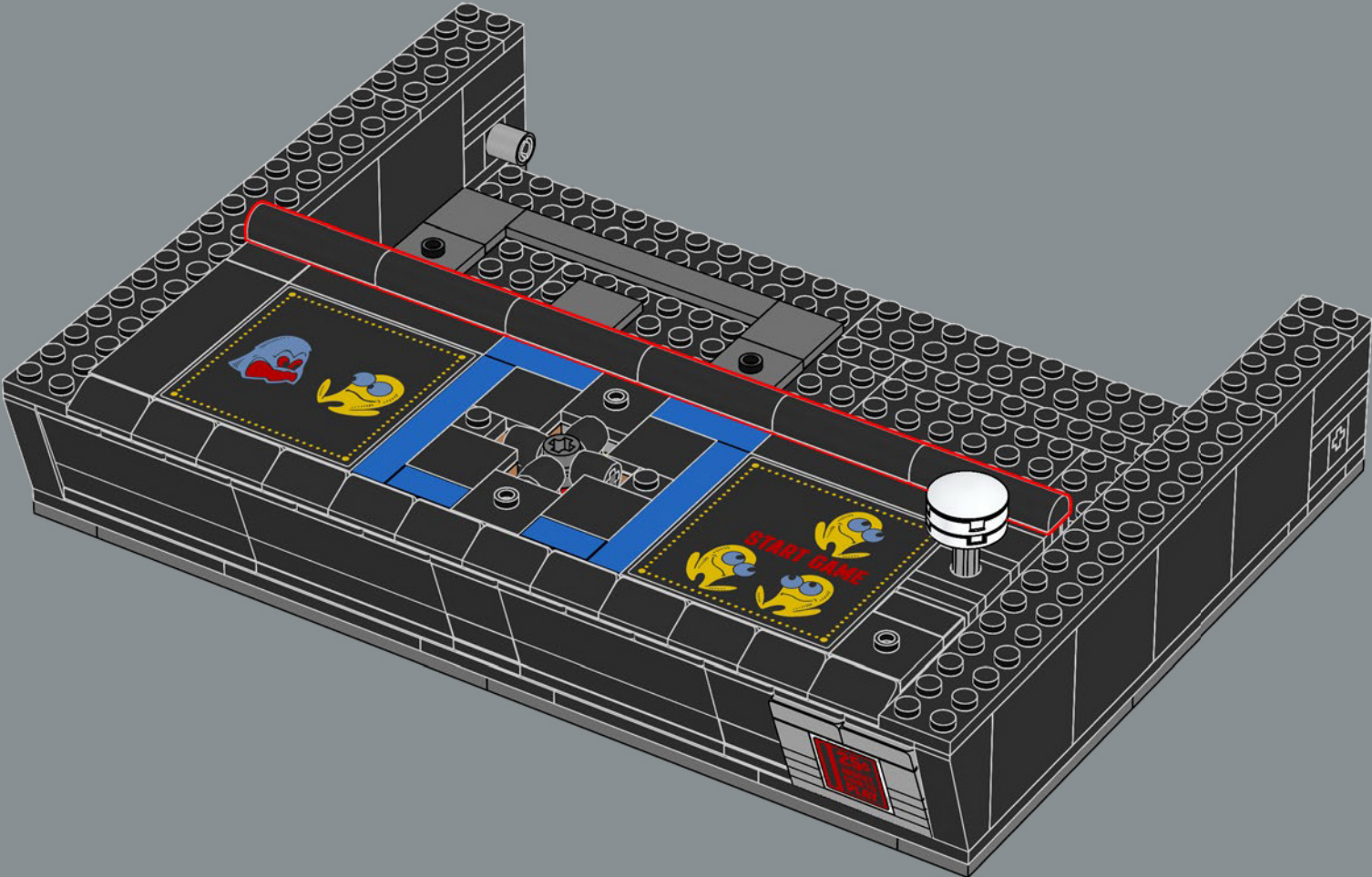



57

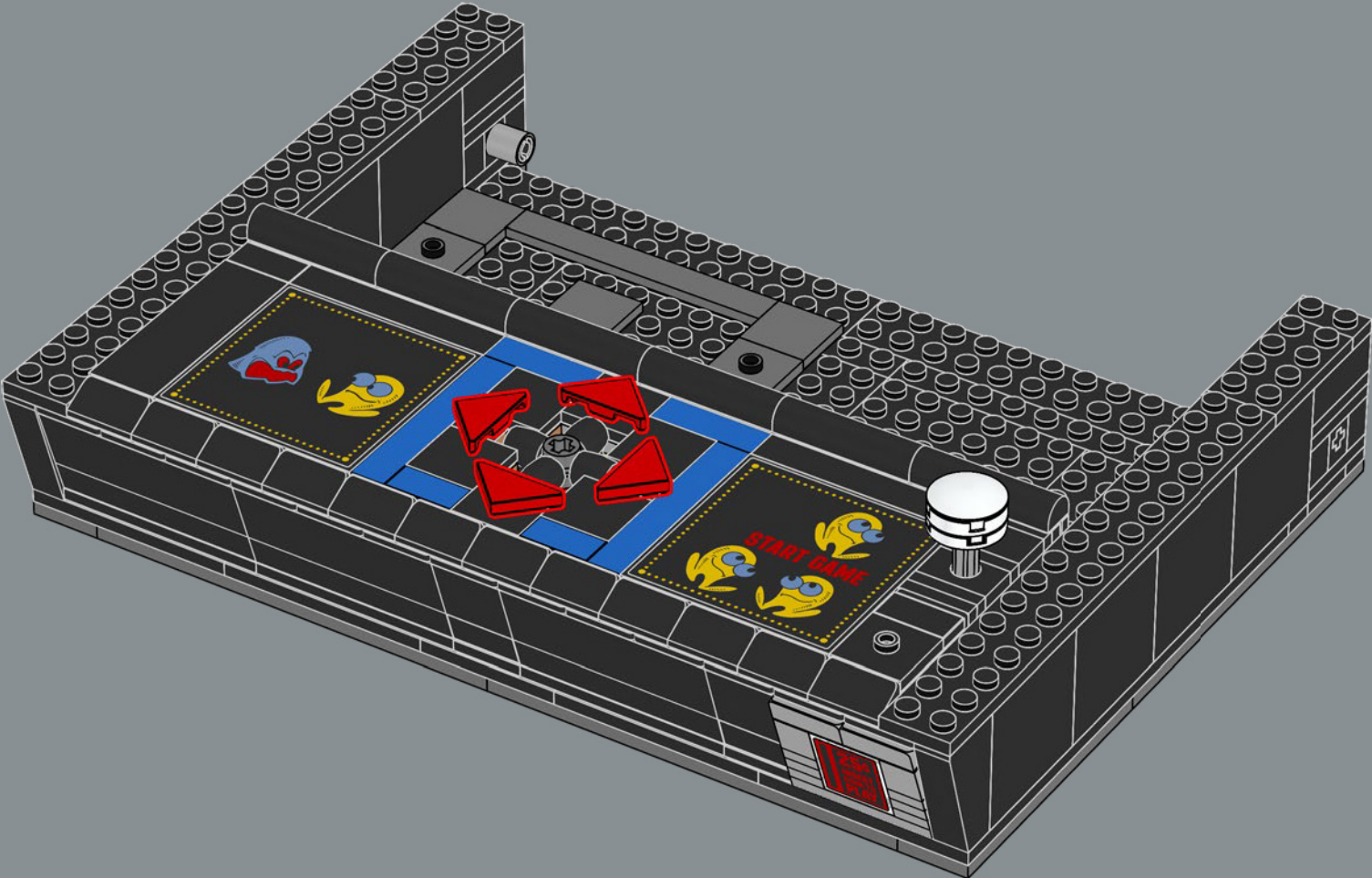

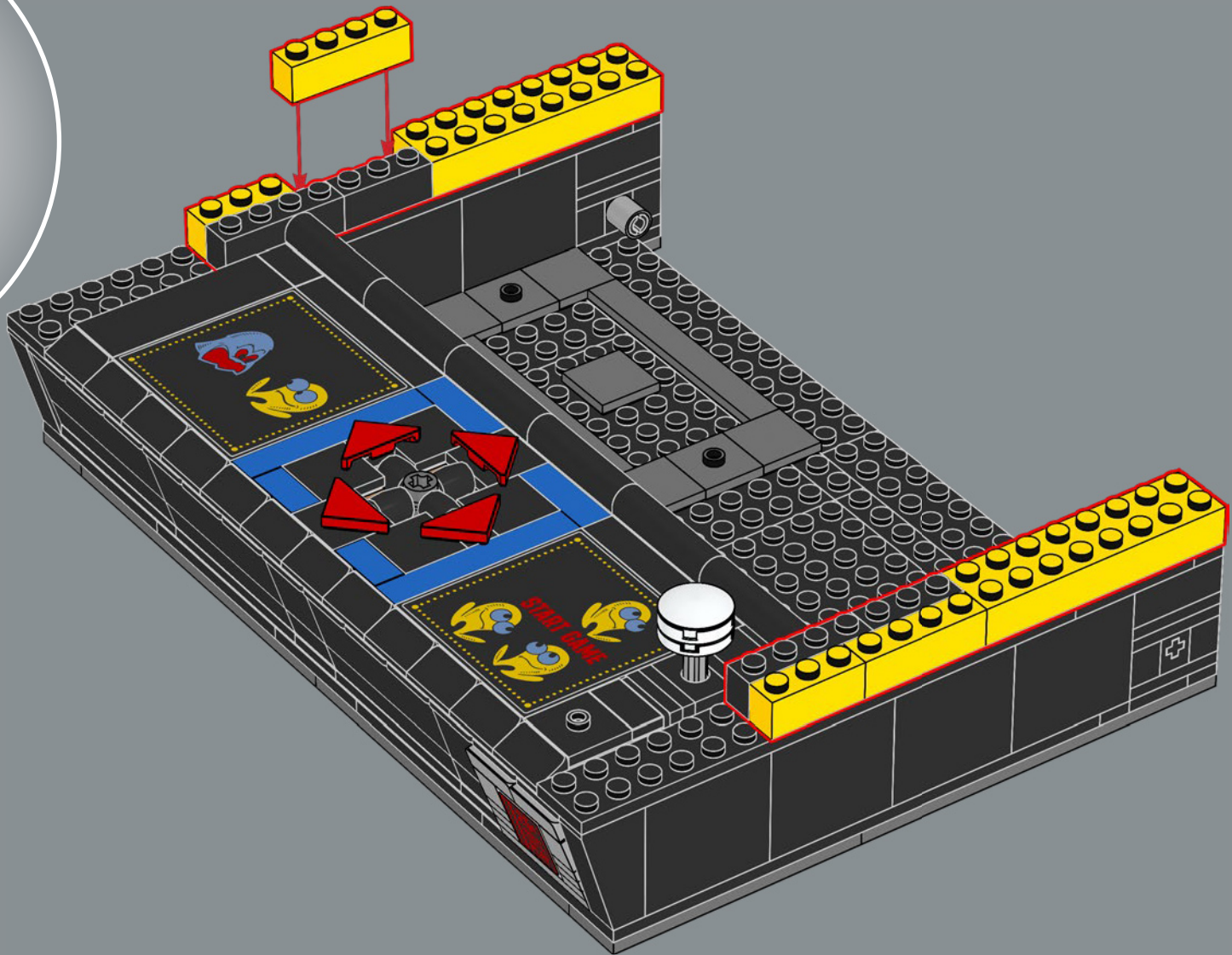
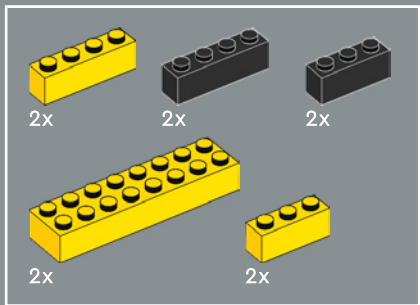

58





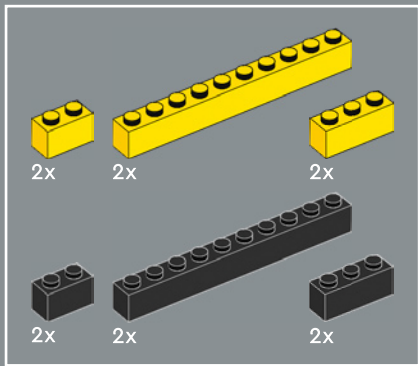

59

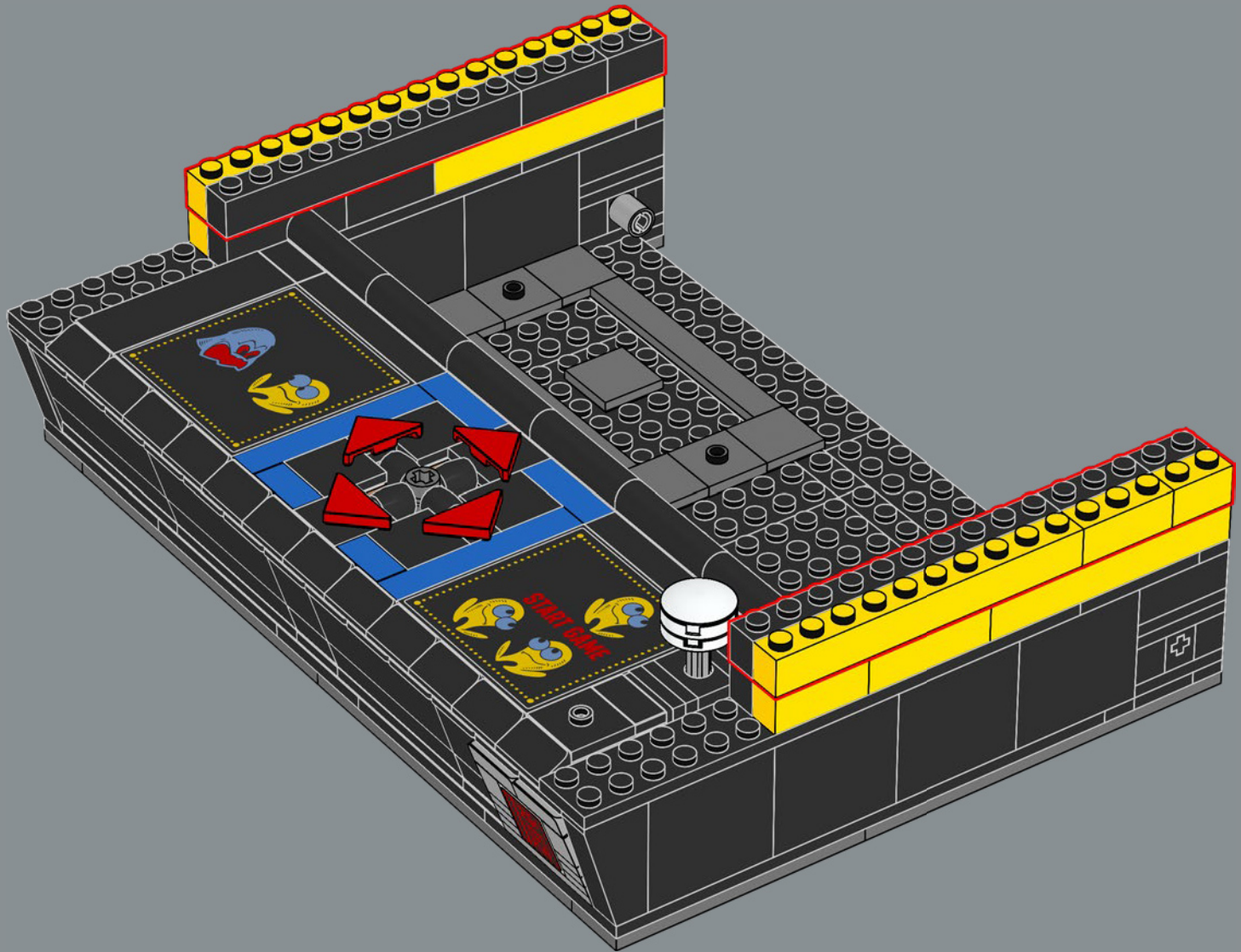

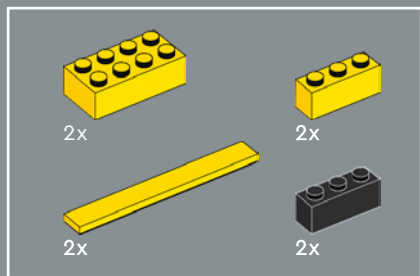

60

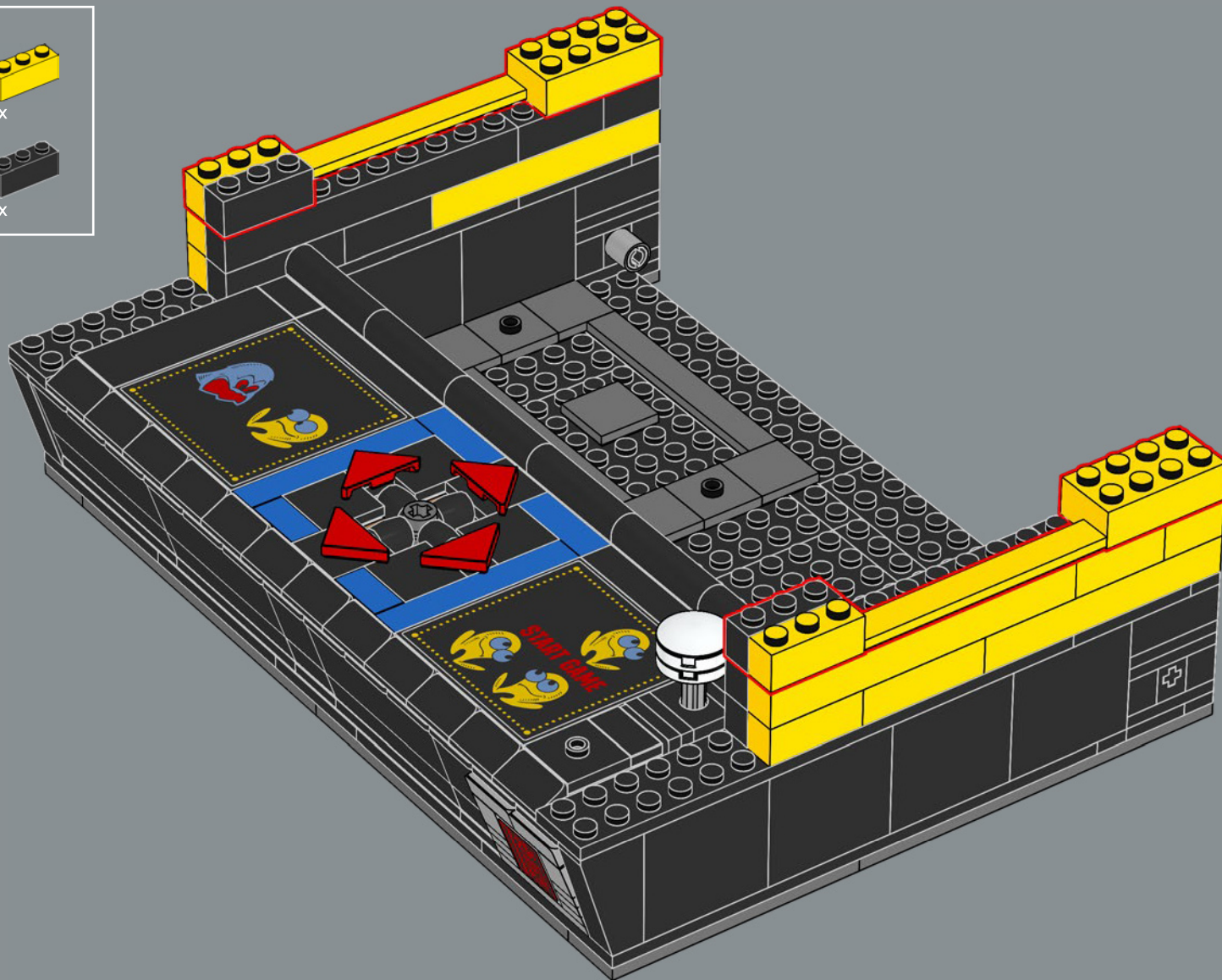

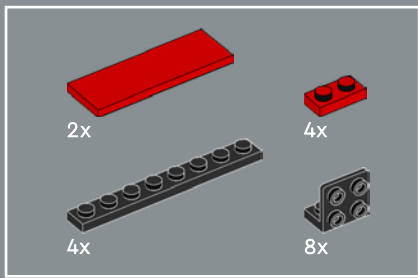

61

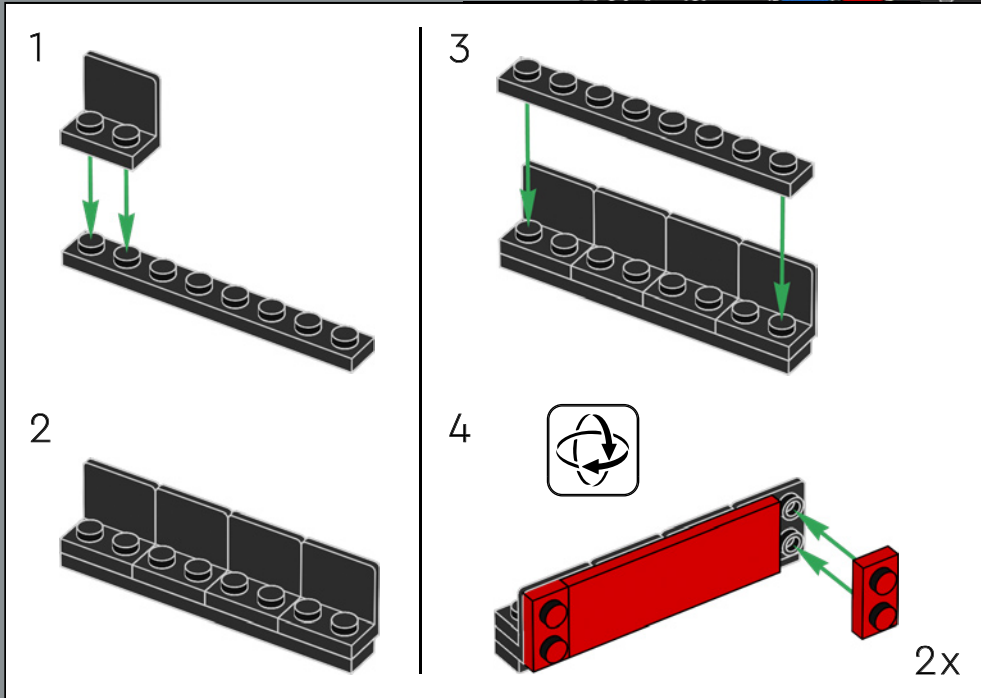
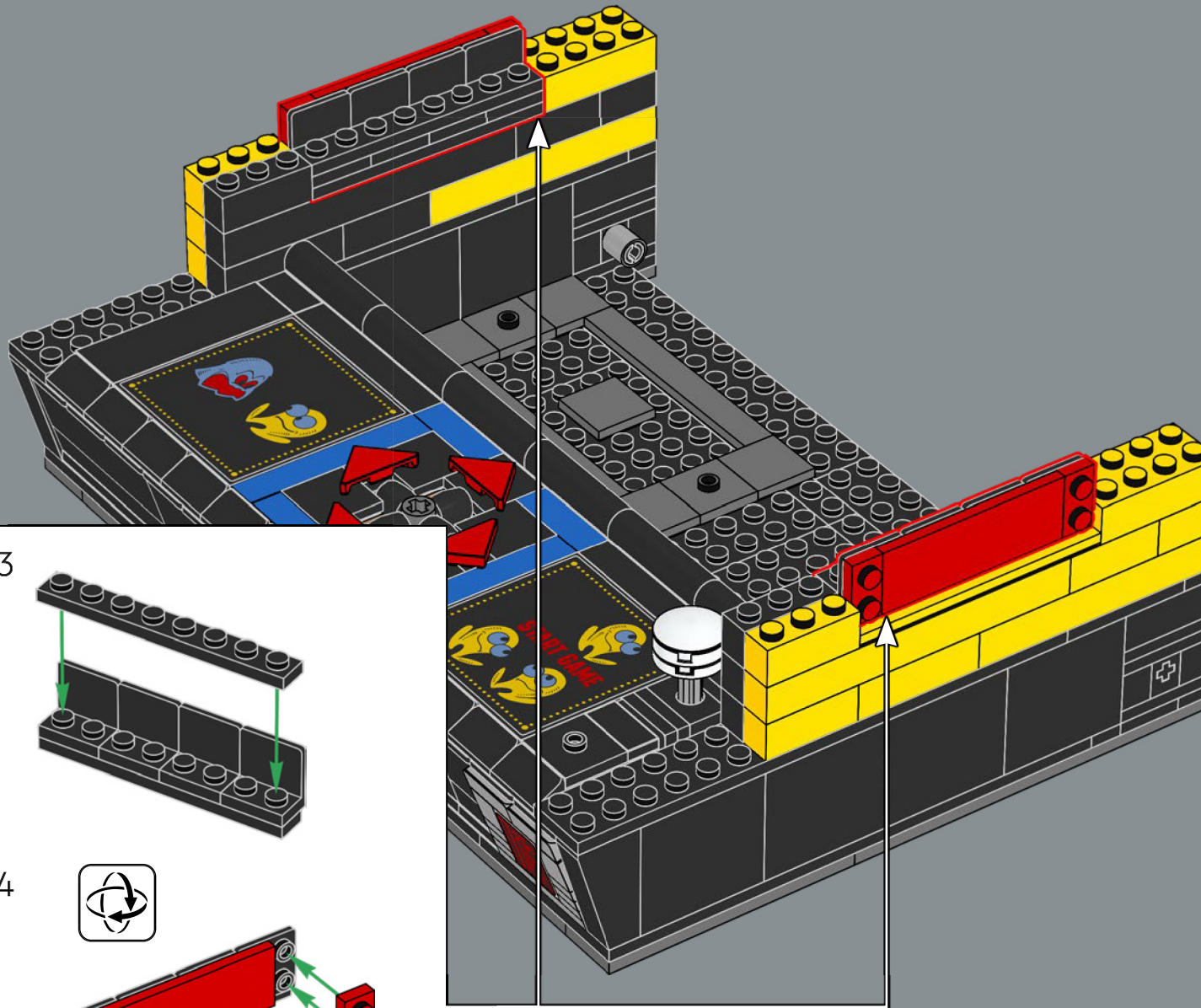

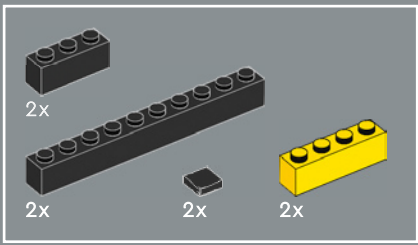

62

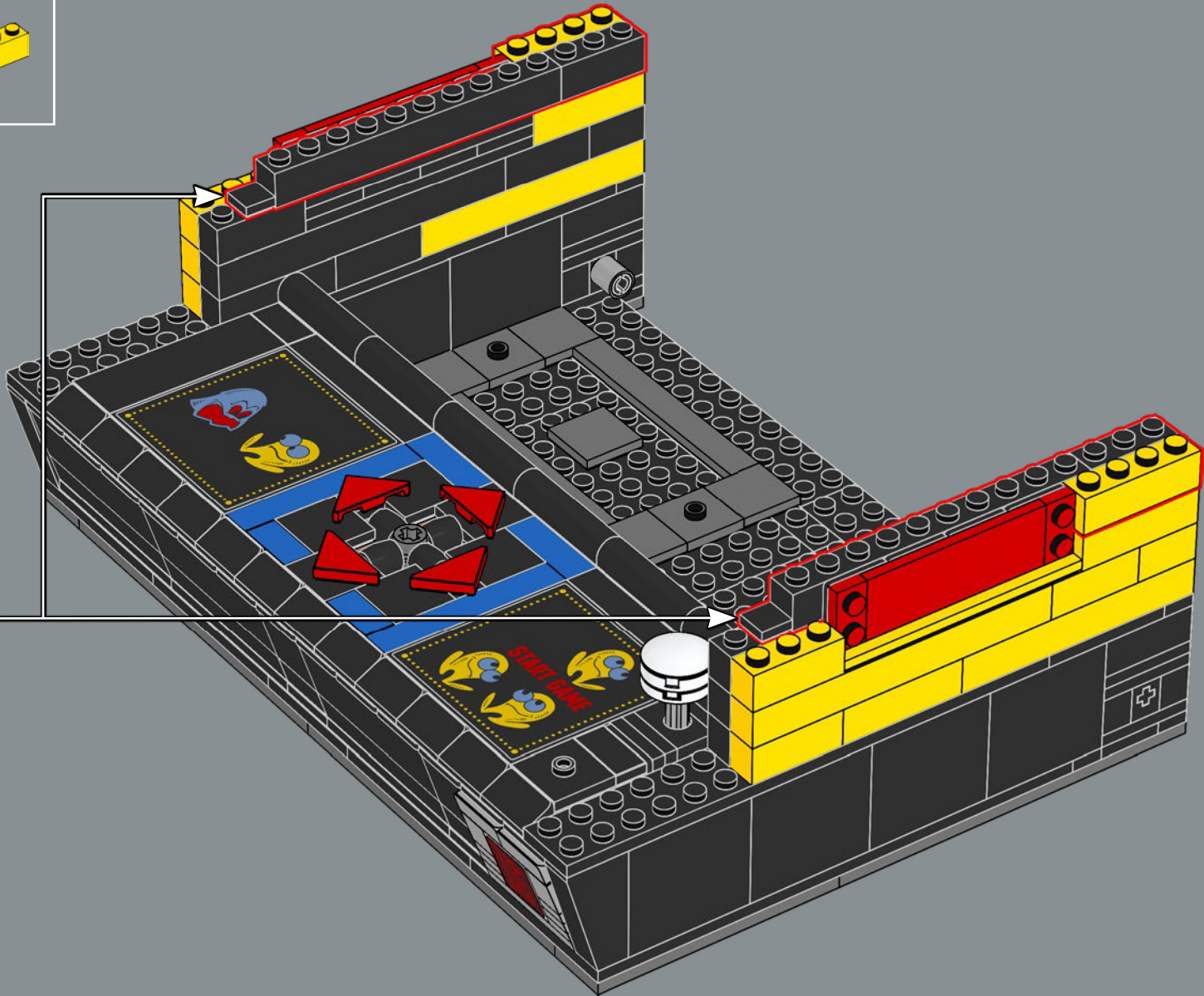

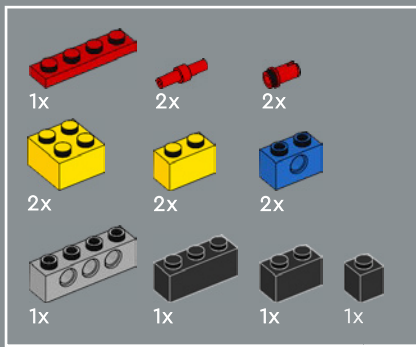

63

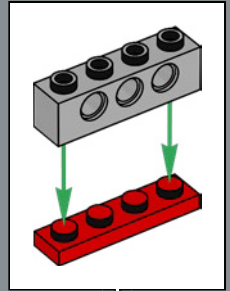
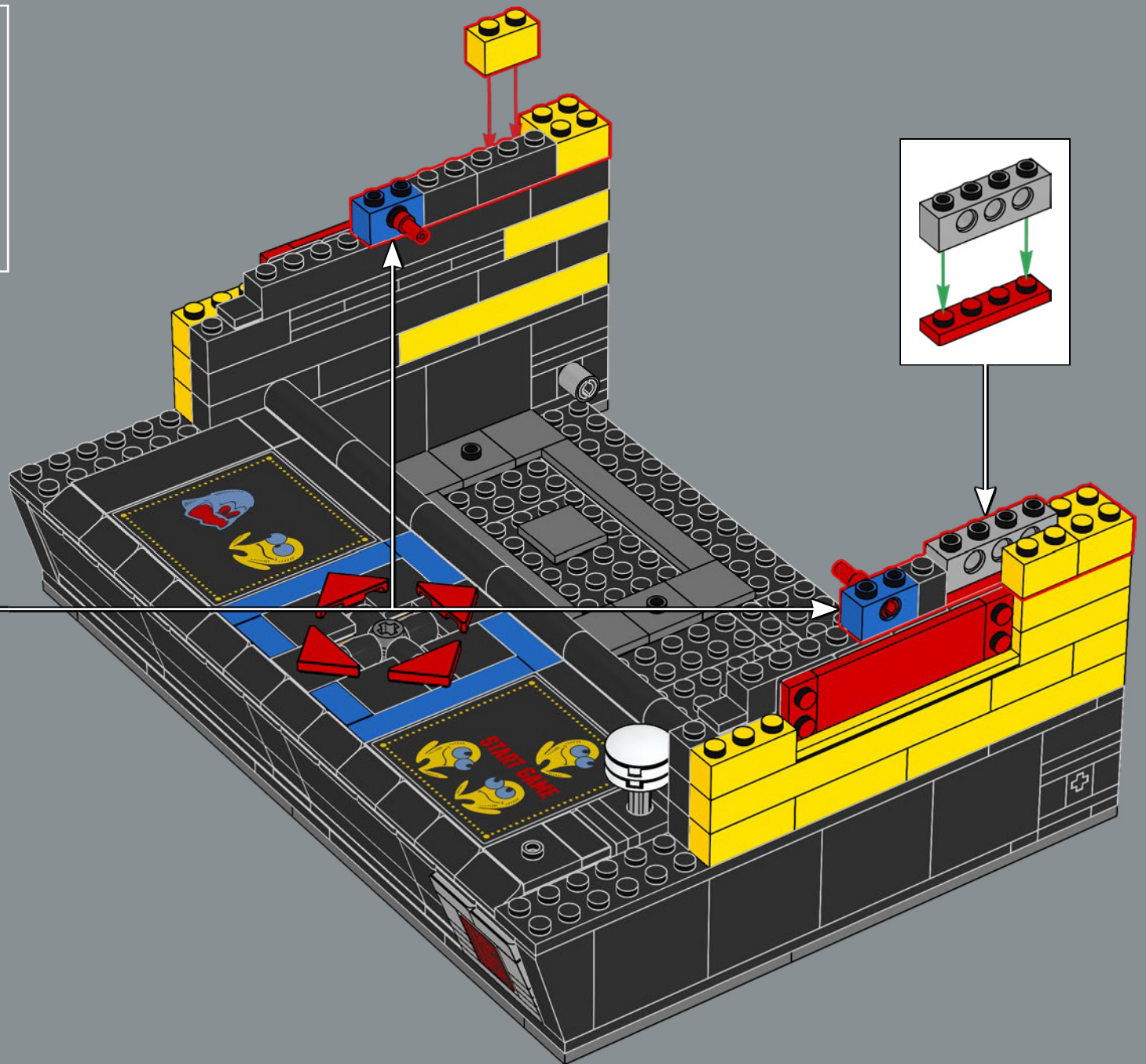
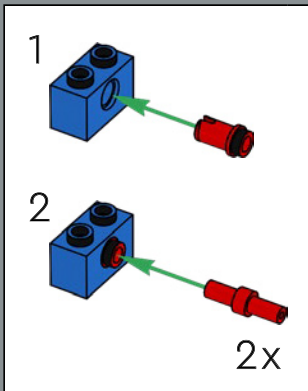

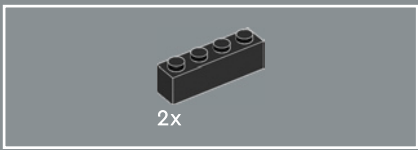

64

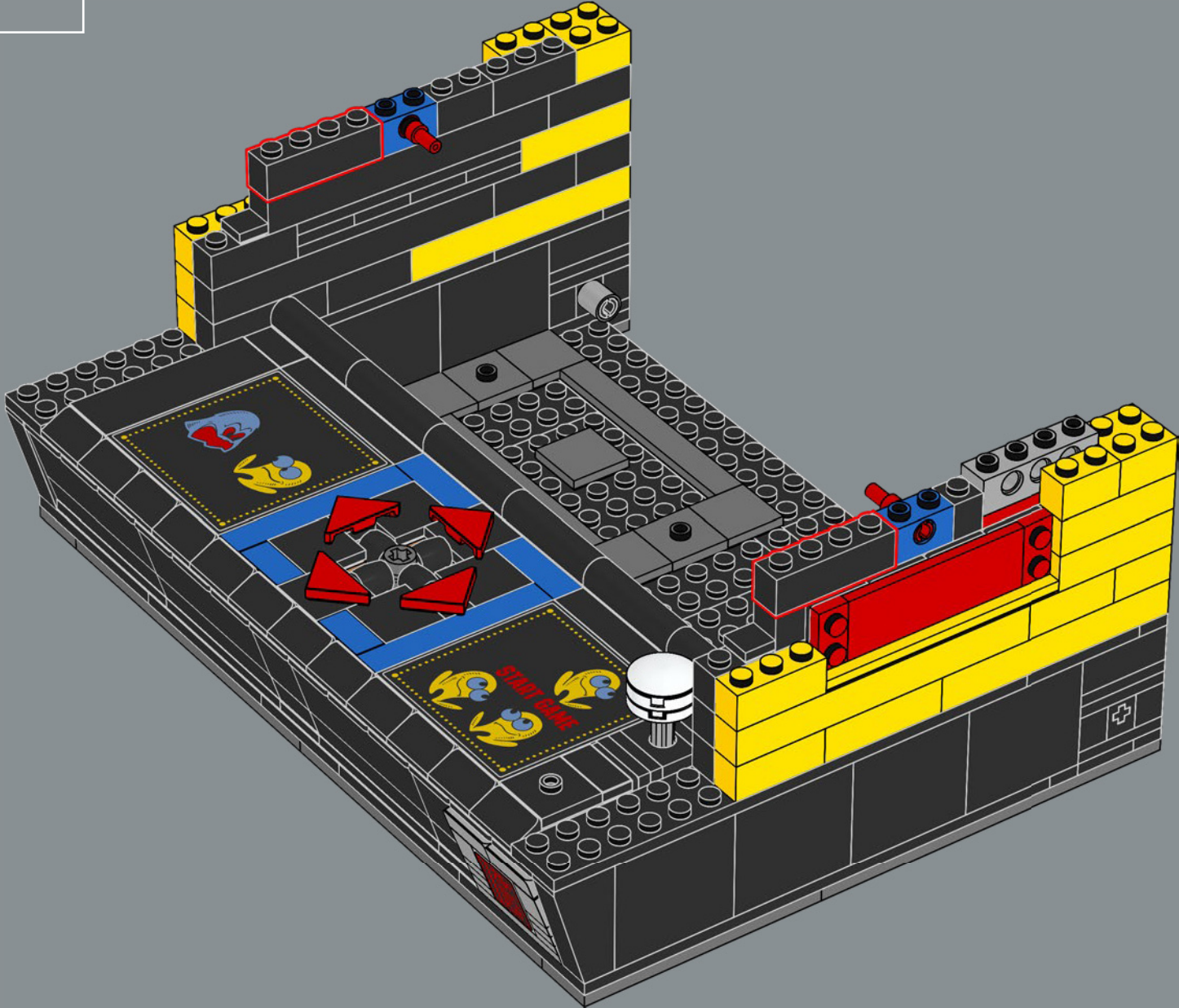

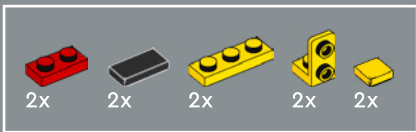

65

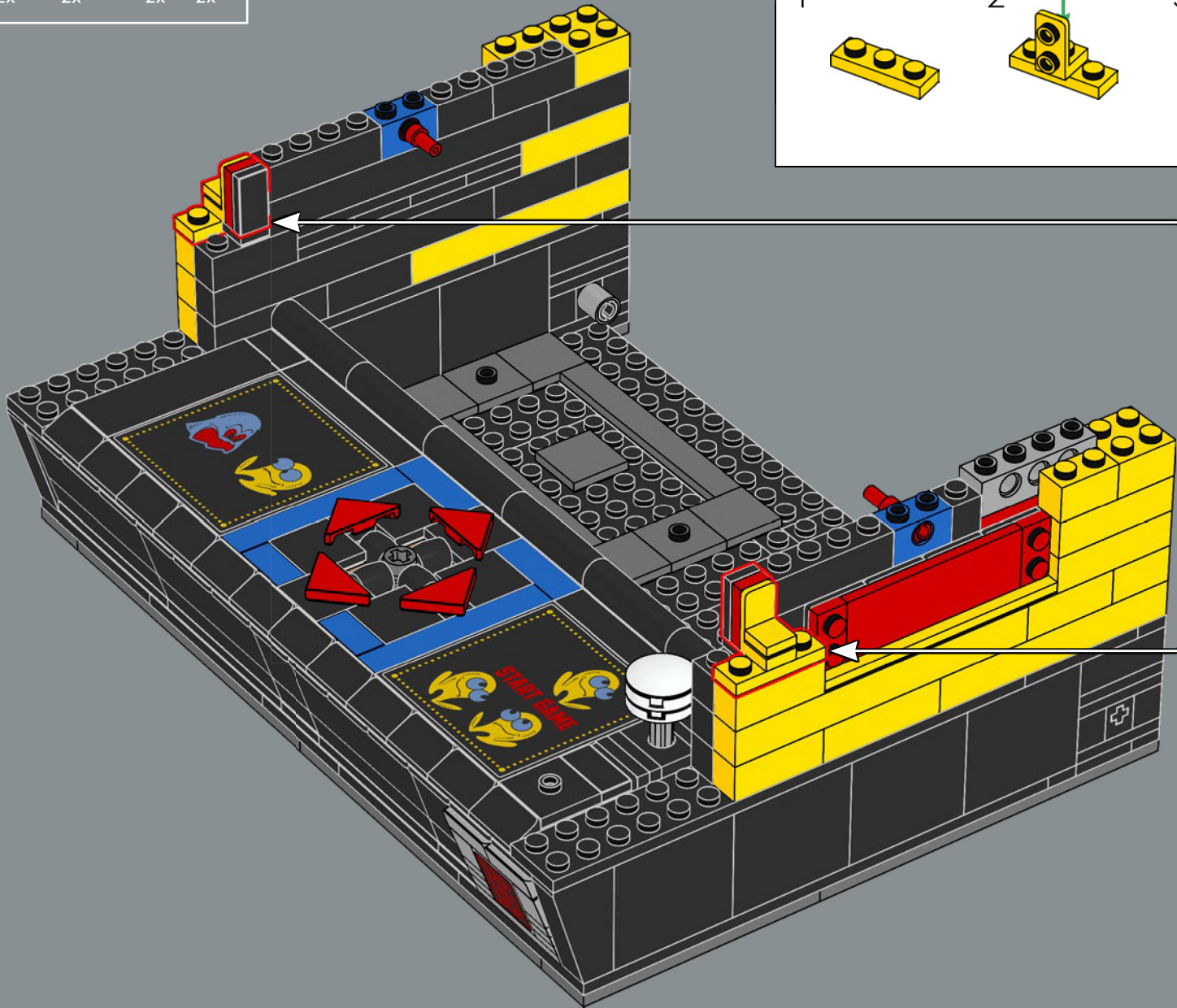
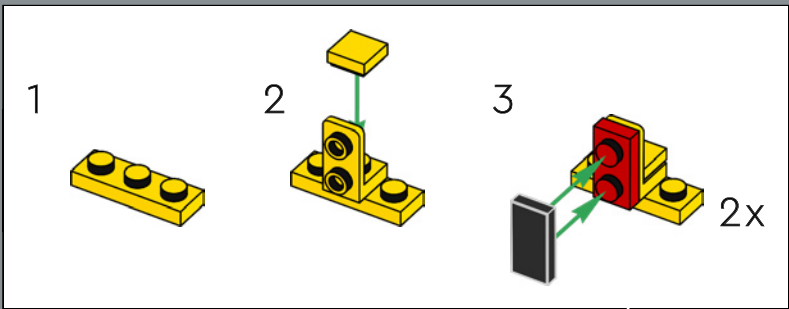



4x

66

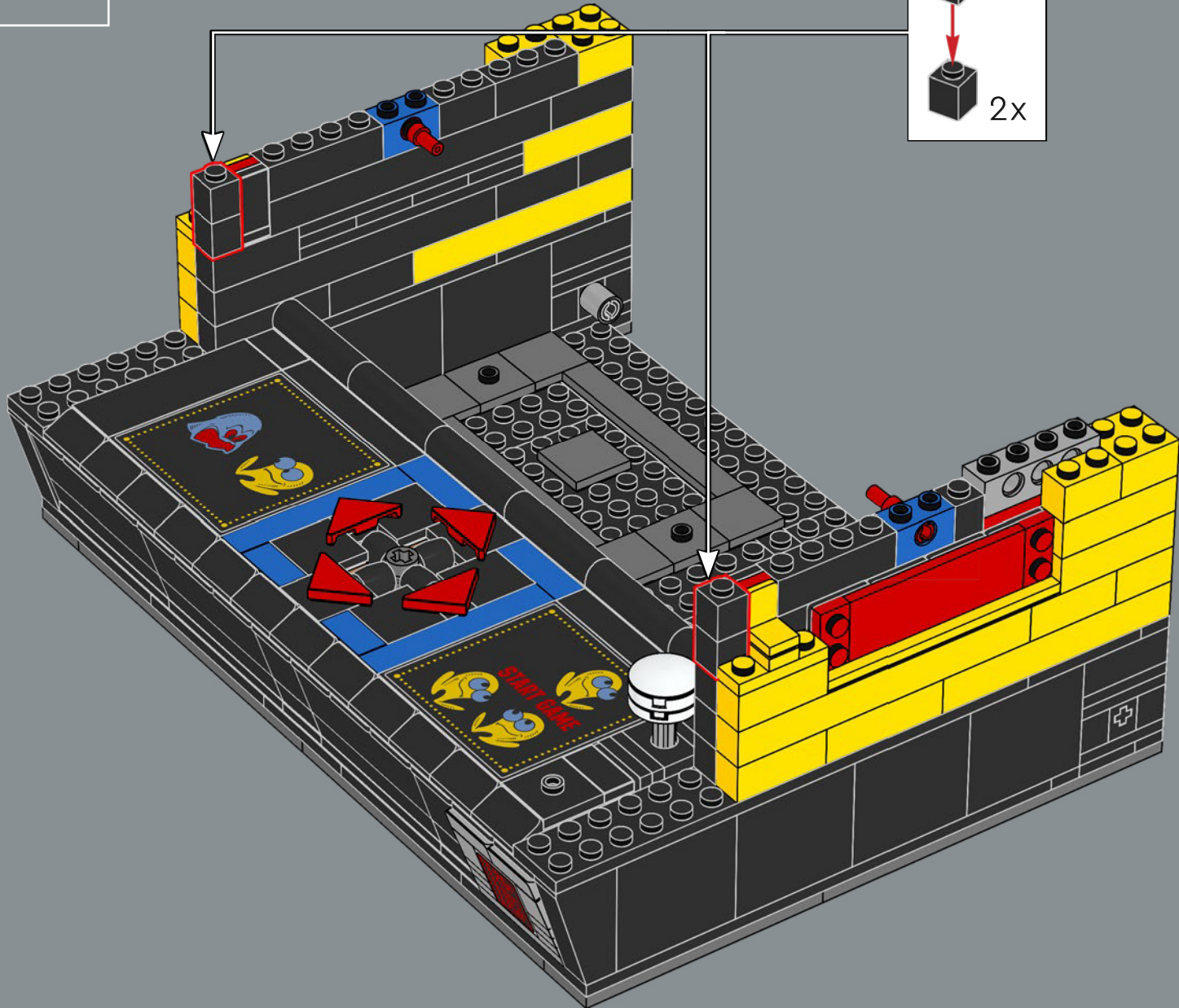

2x





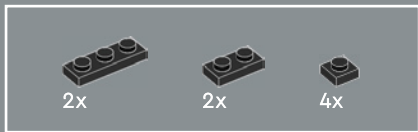

67

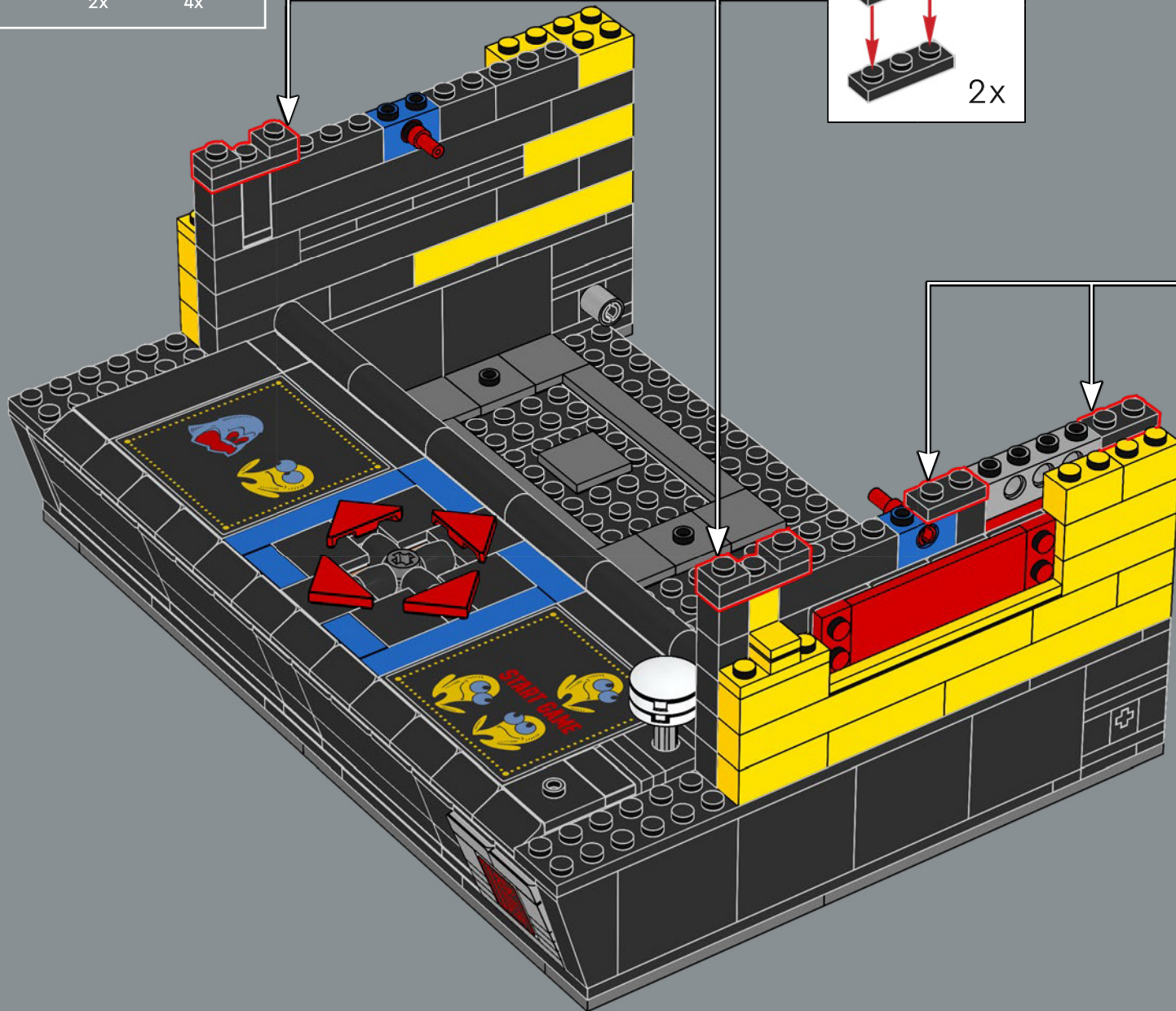
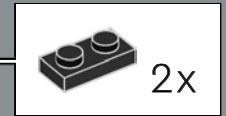
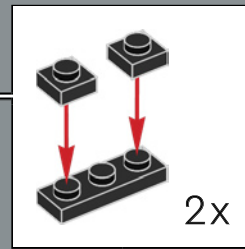

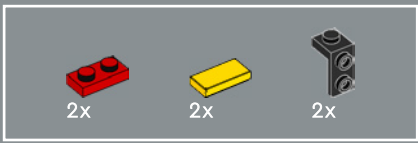

68

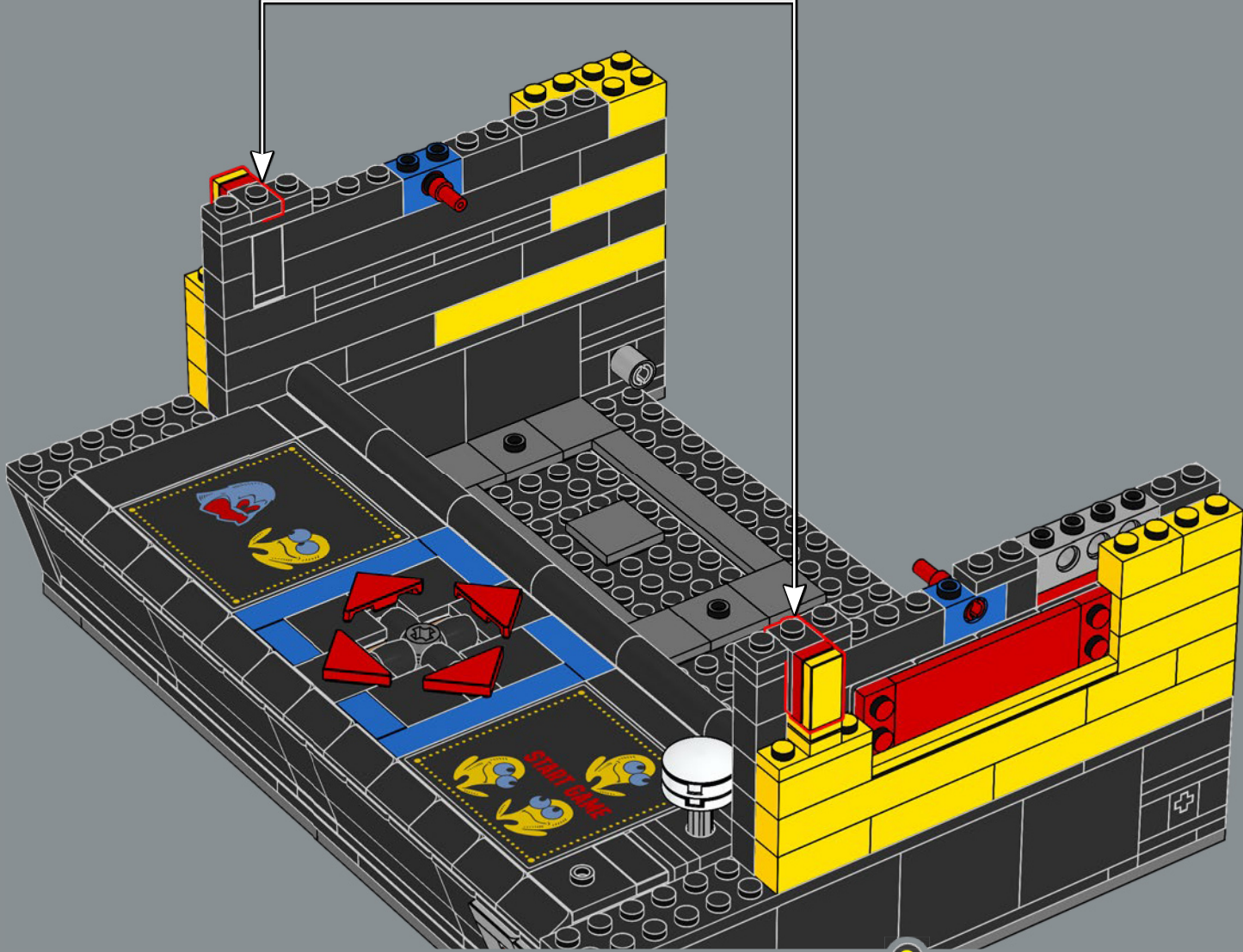
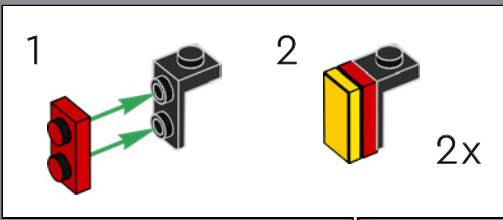

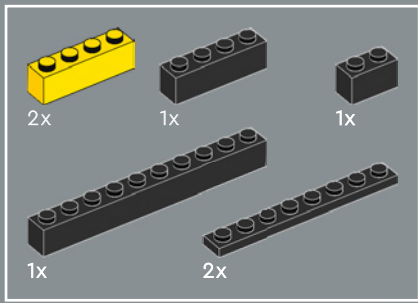

69

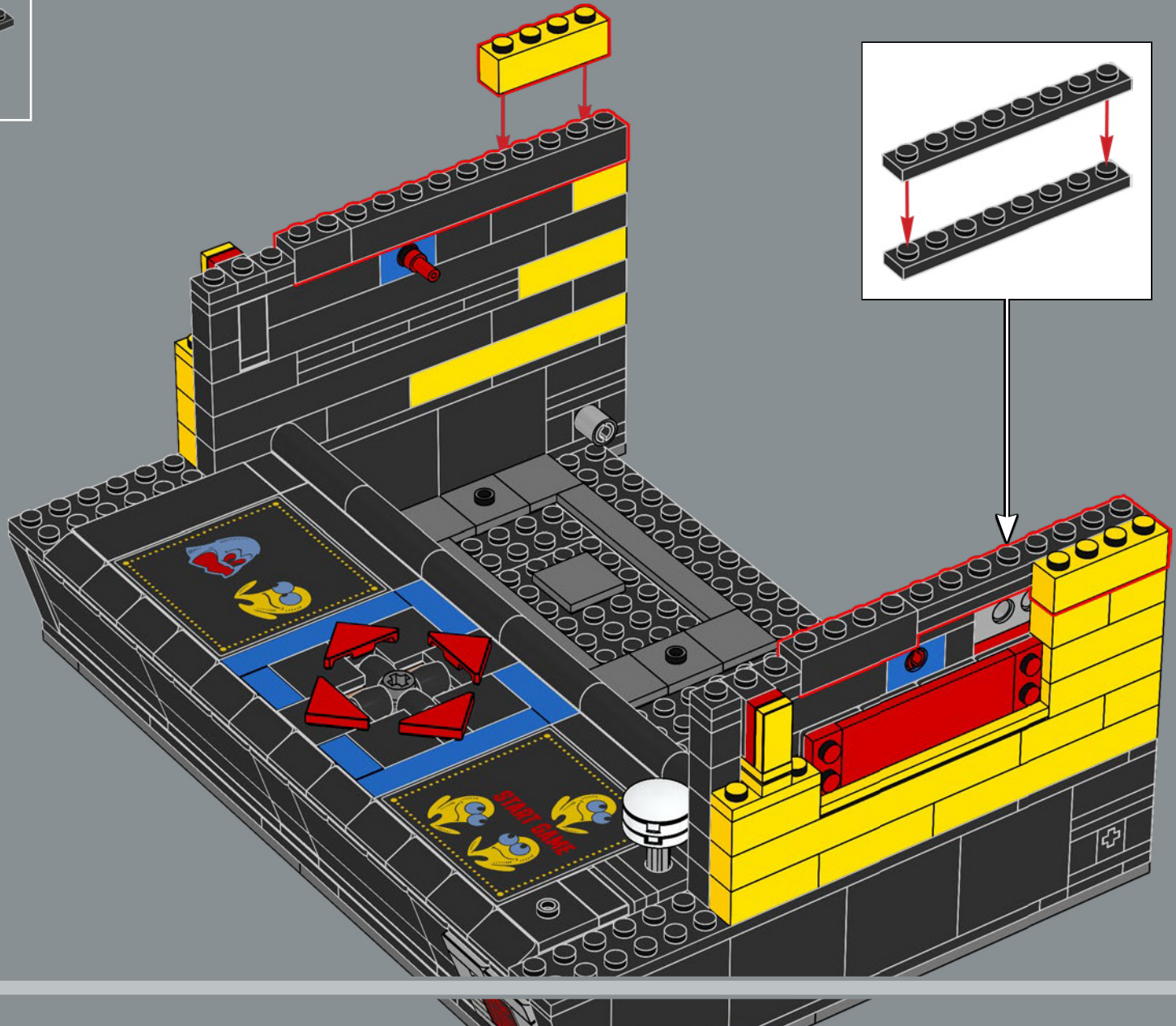

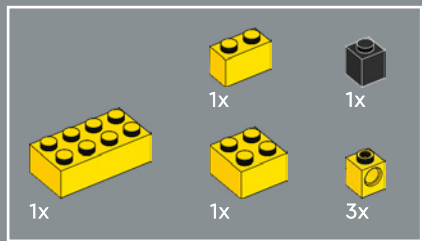

70

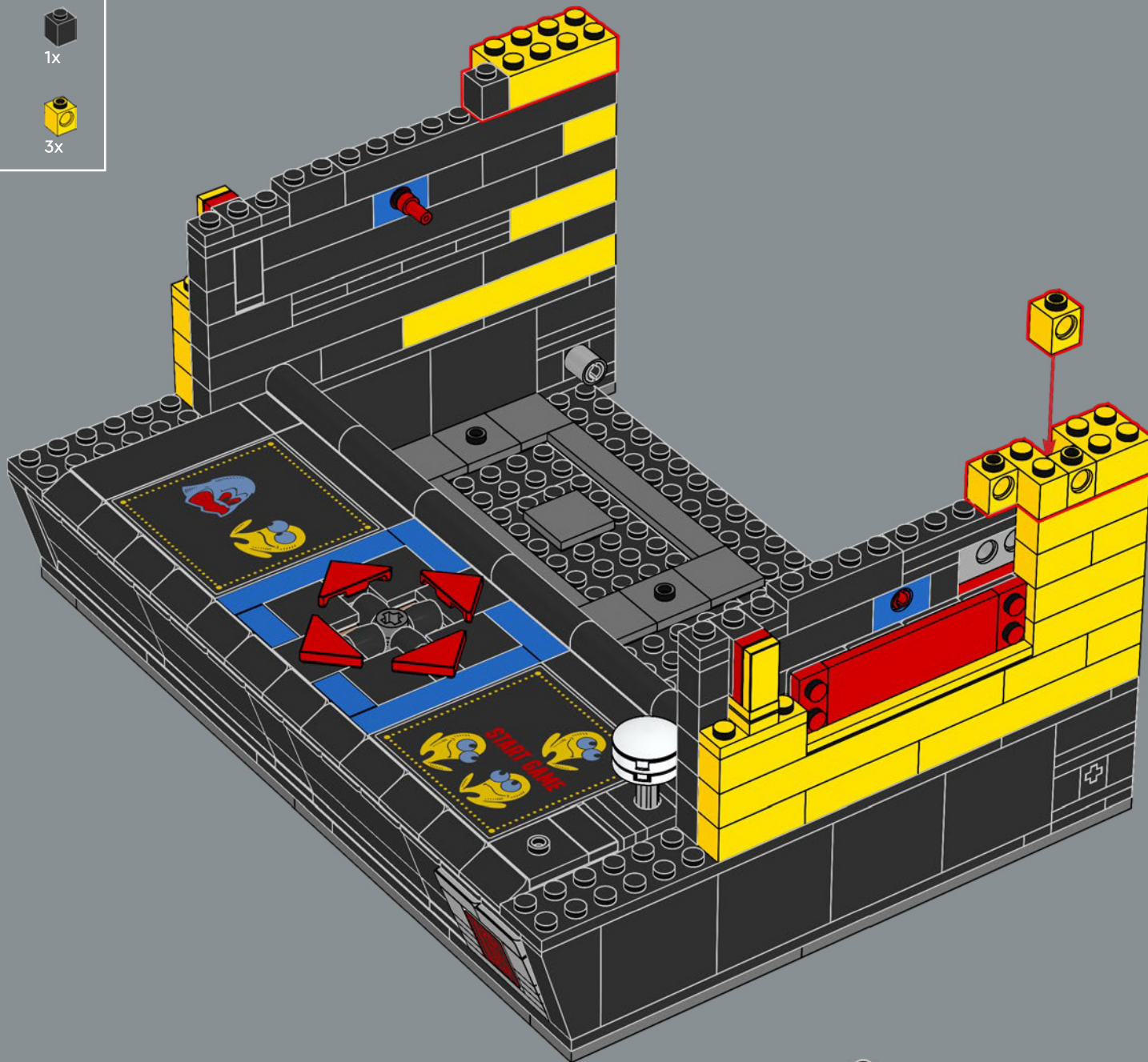

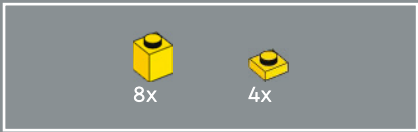

71

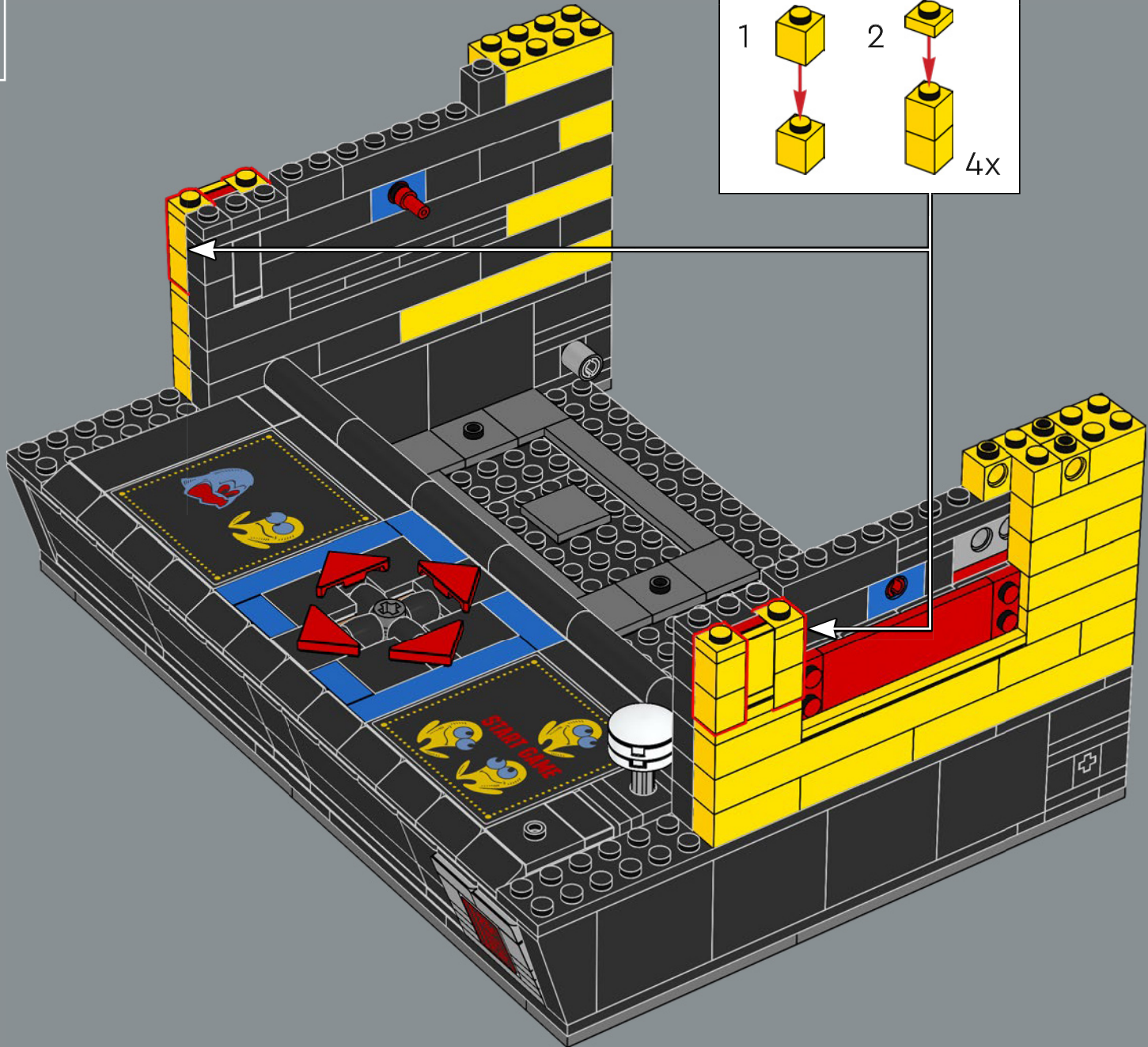
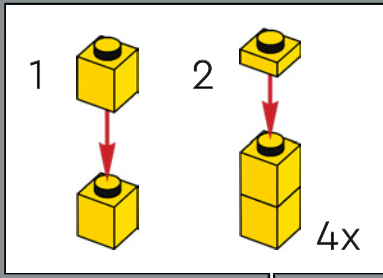



72

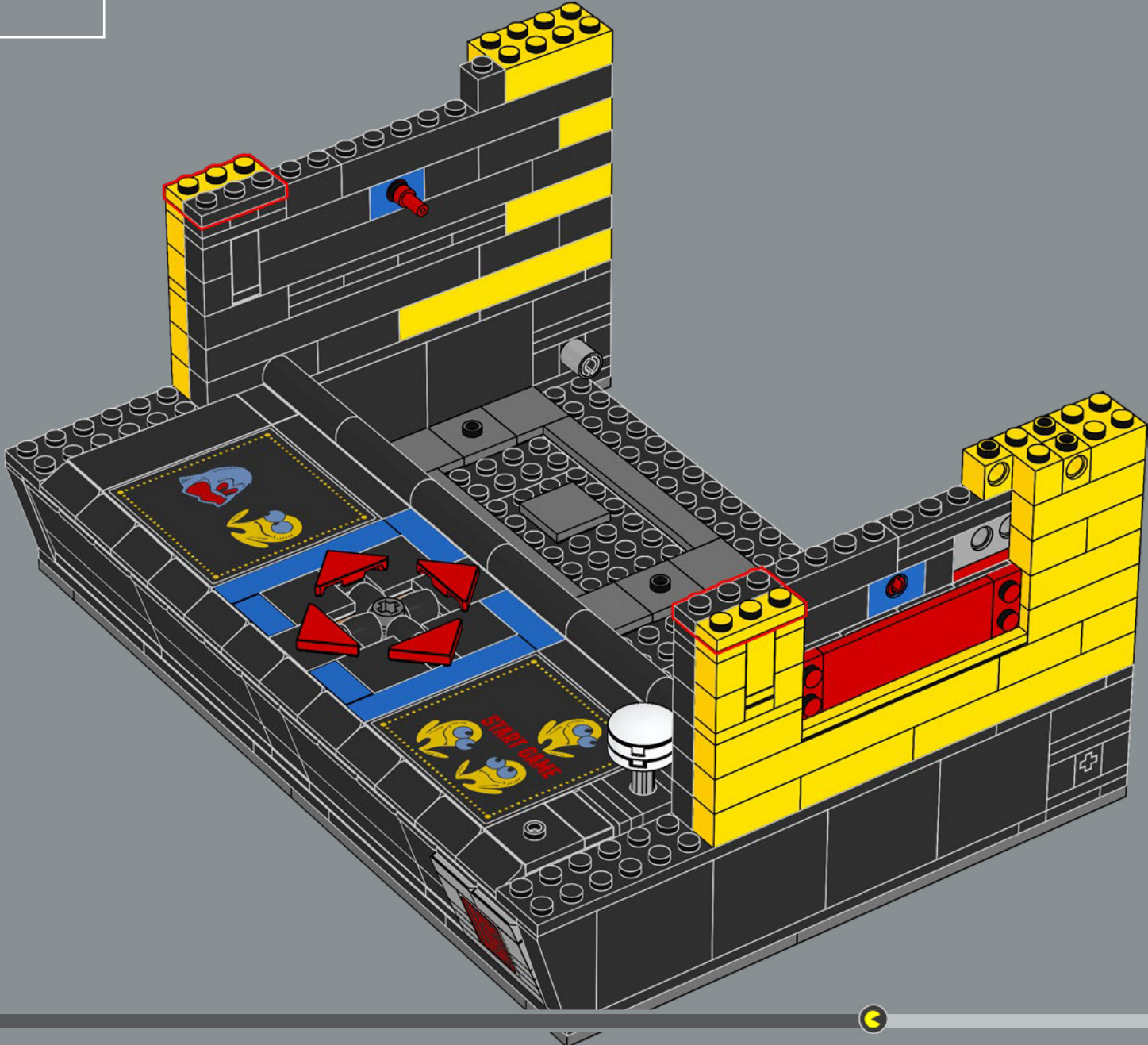

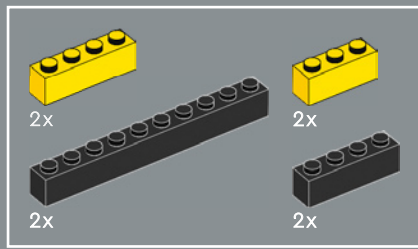

73

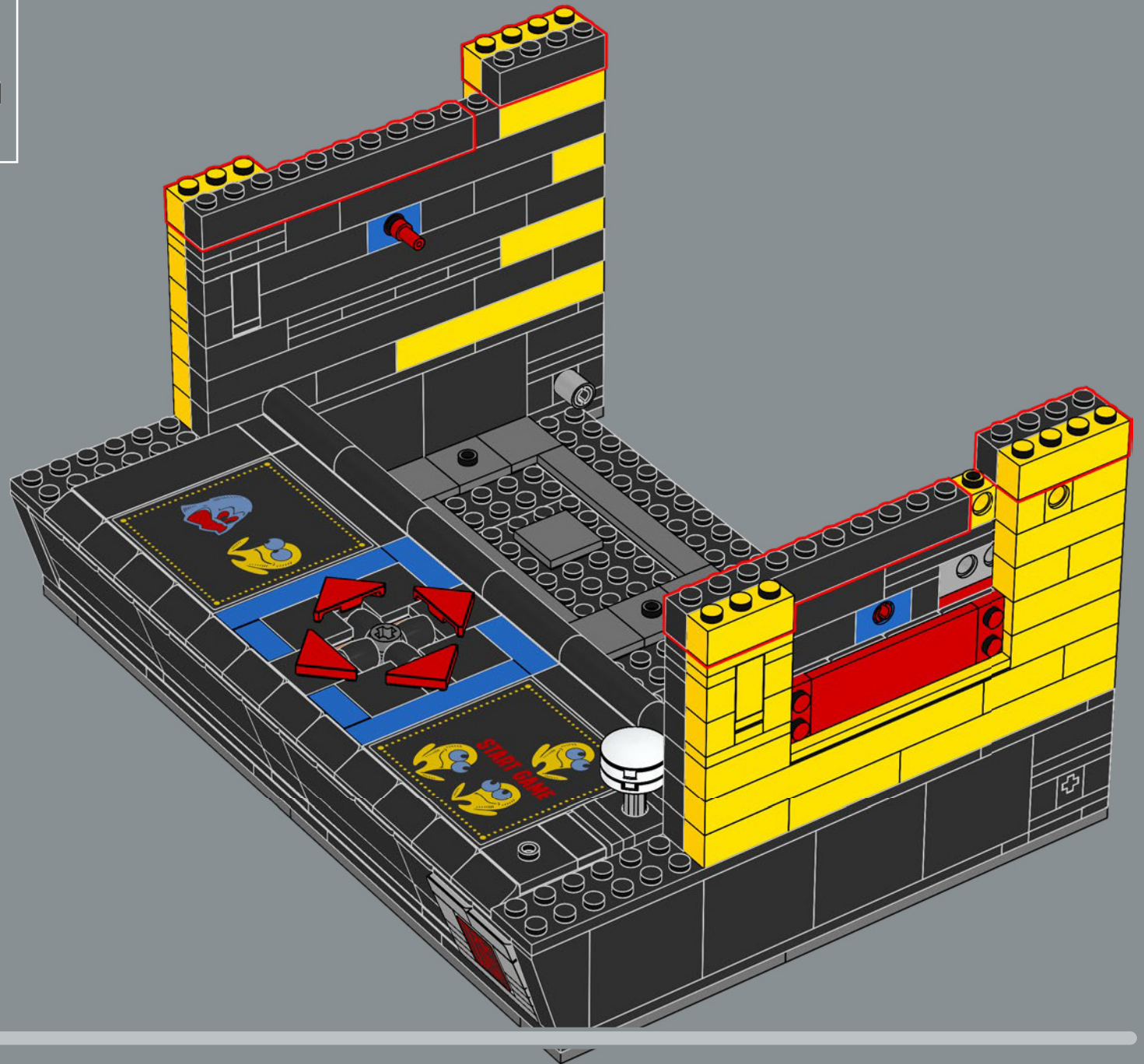

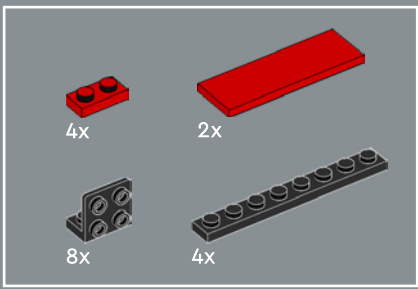

74

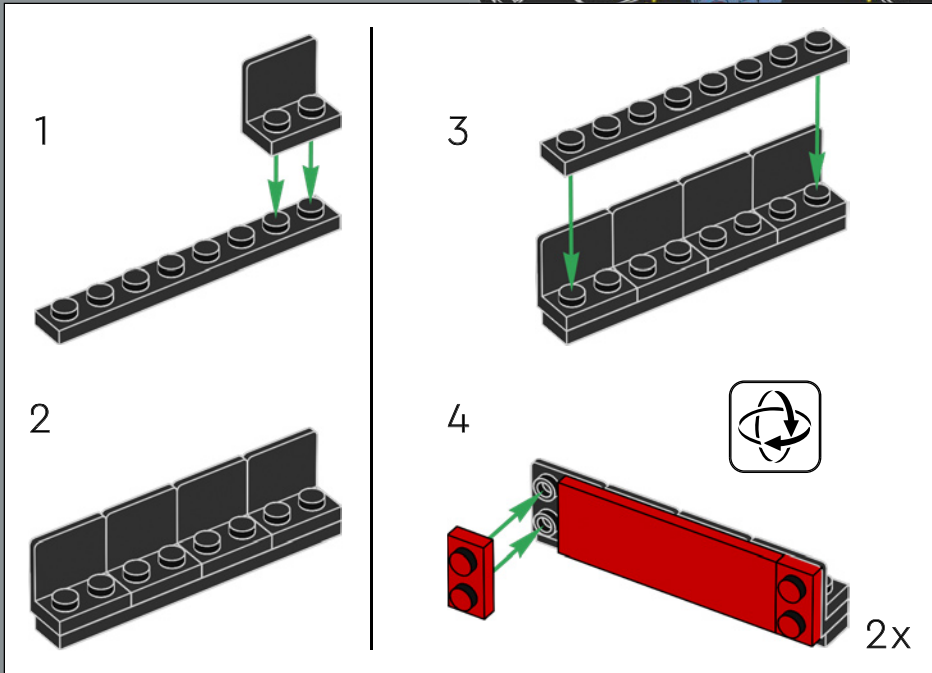
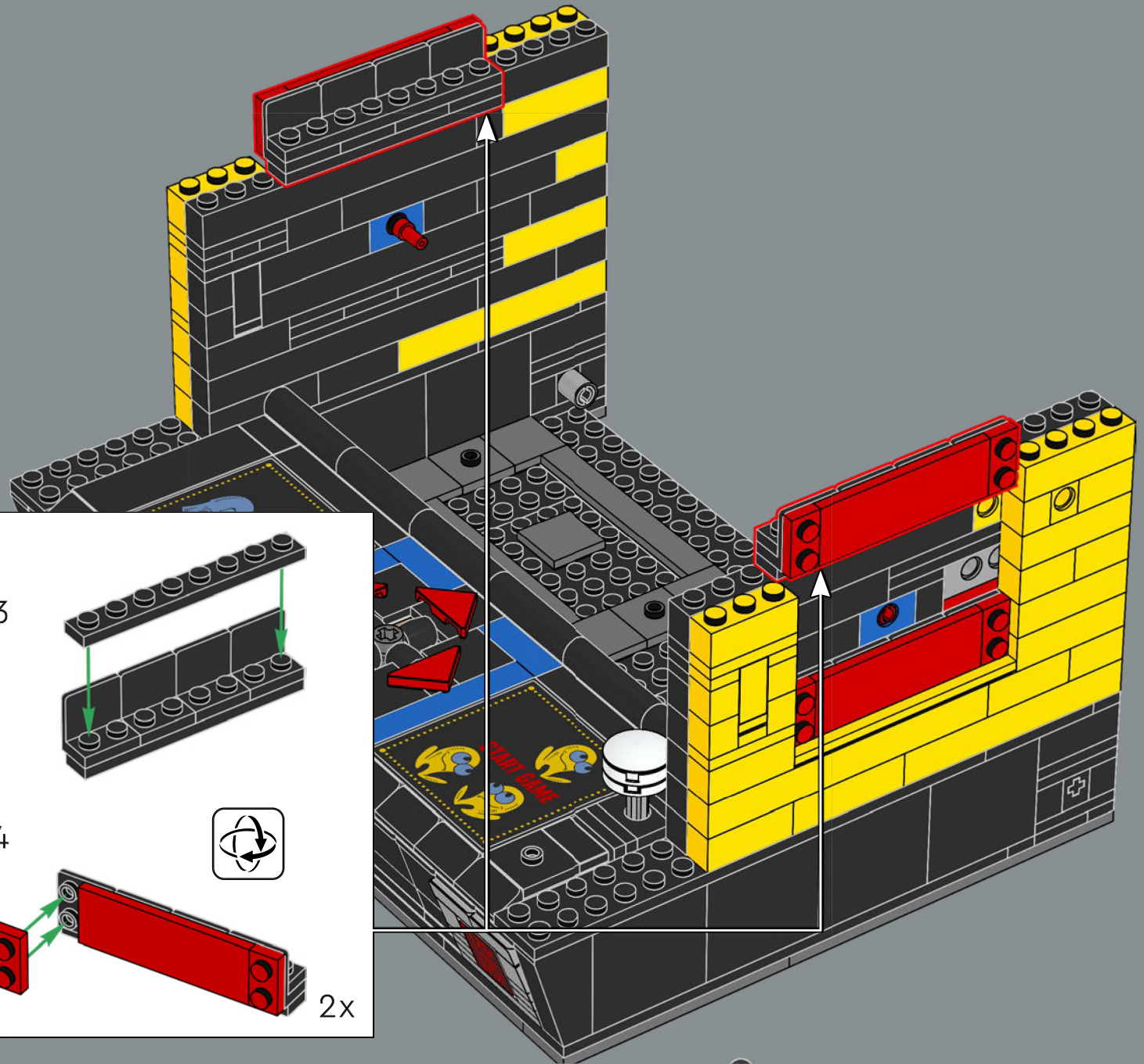





2x



2x

75

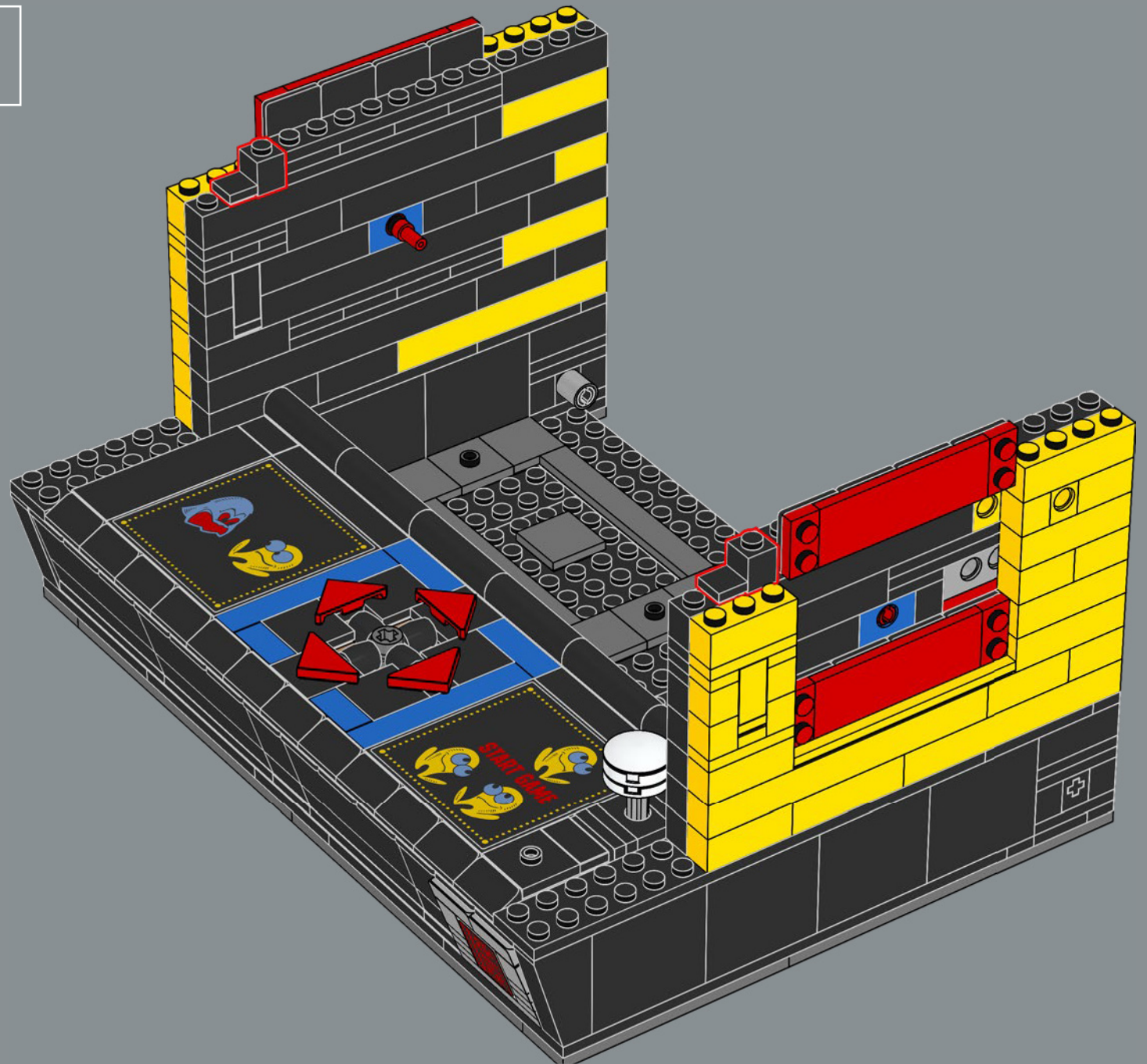

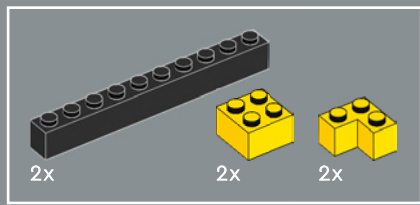

76

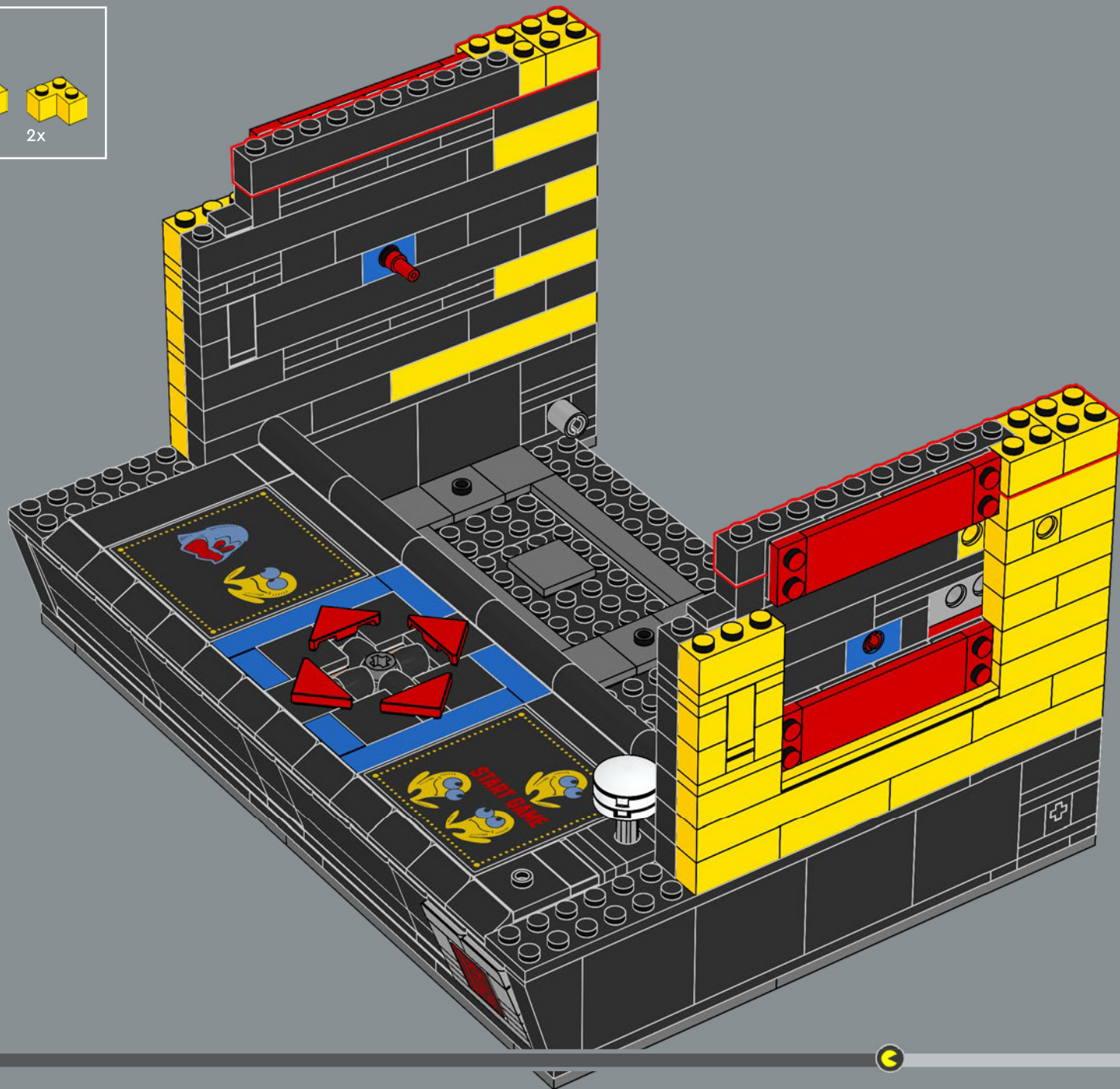

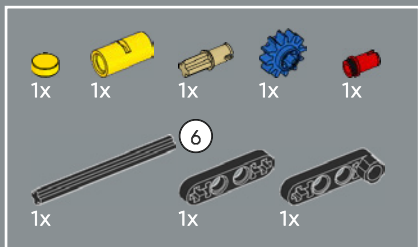

77

1



2

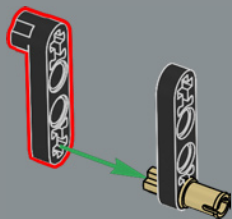

3

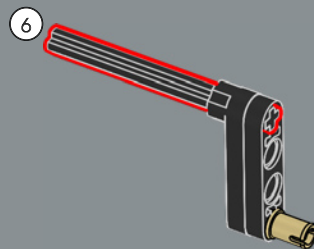

4

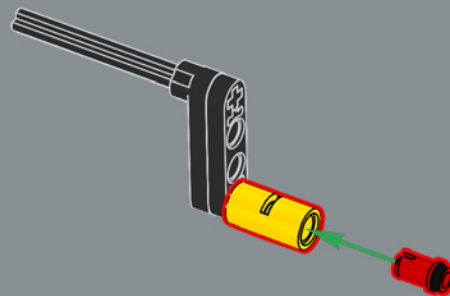

5

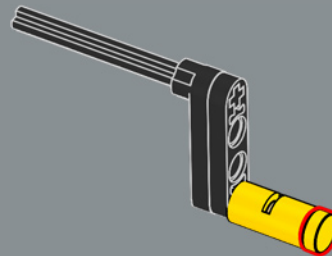

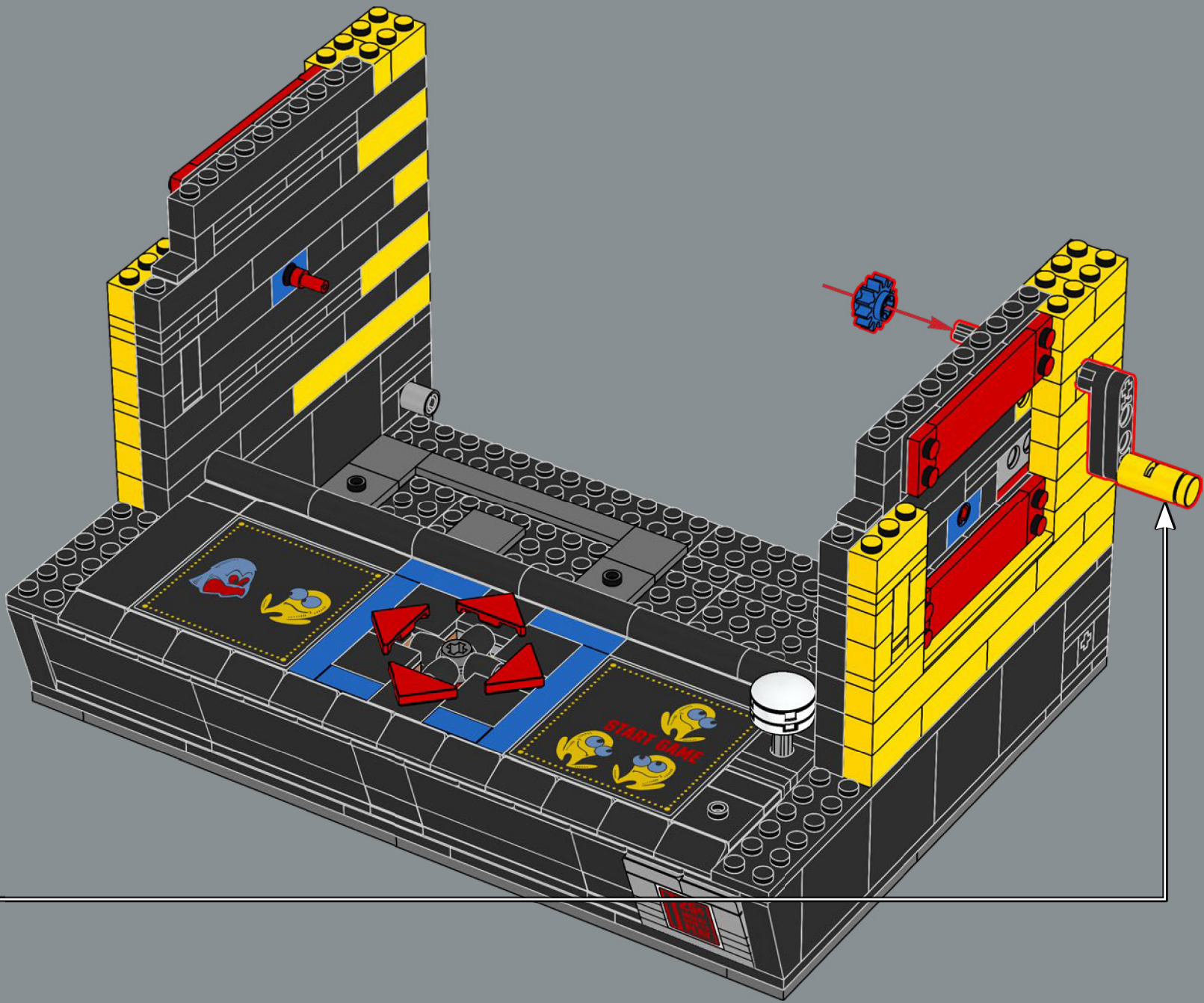

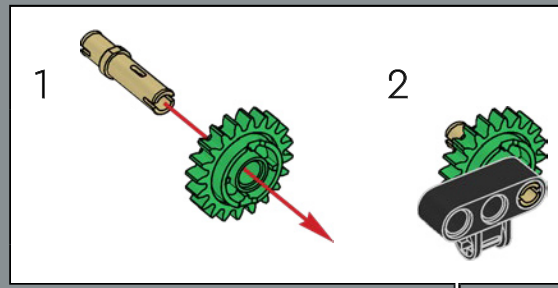
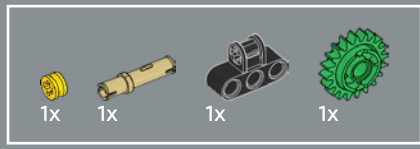

78

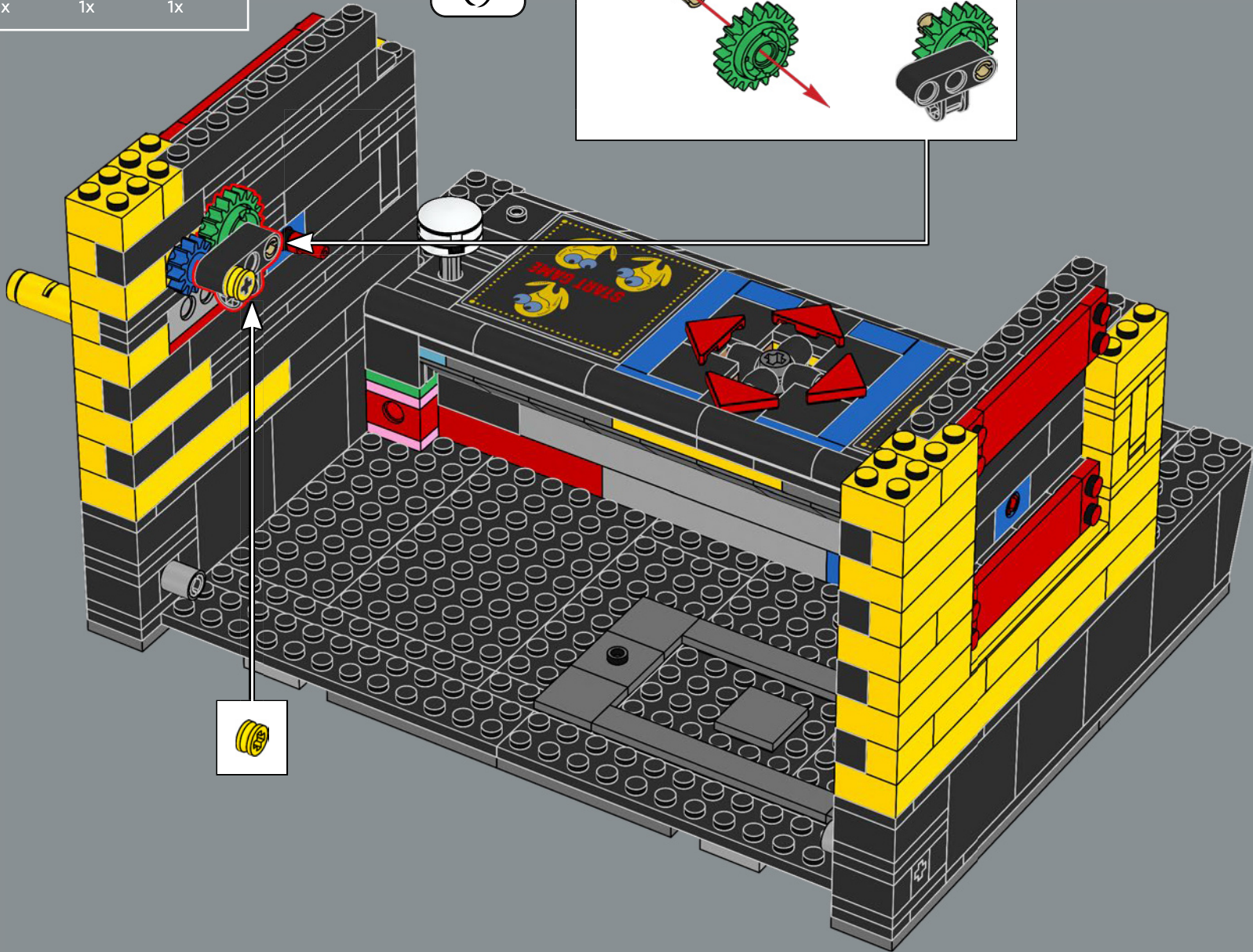

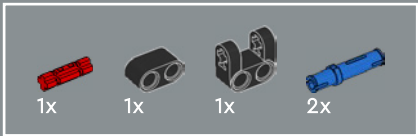

79

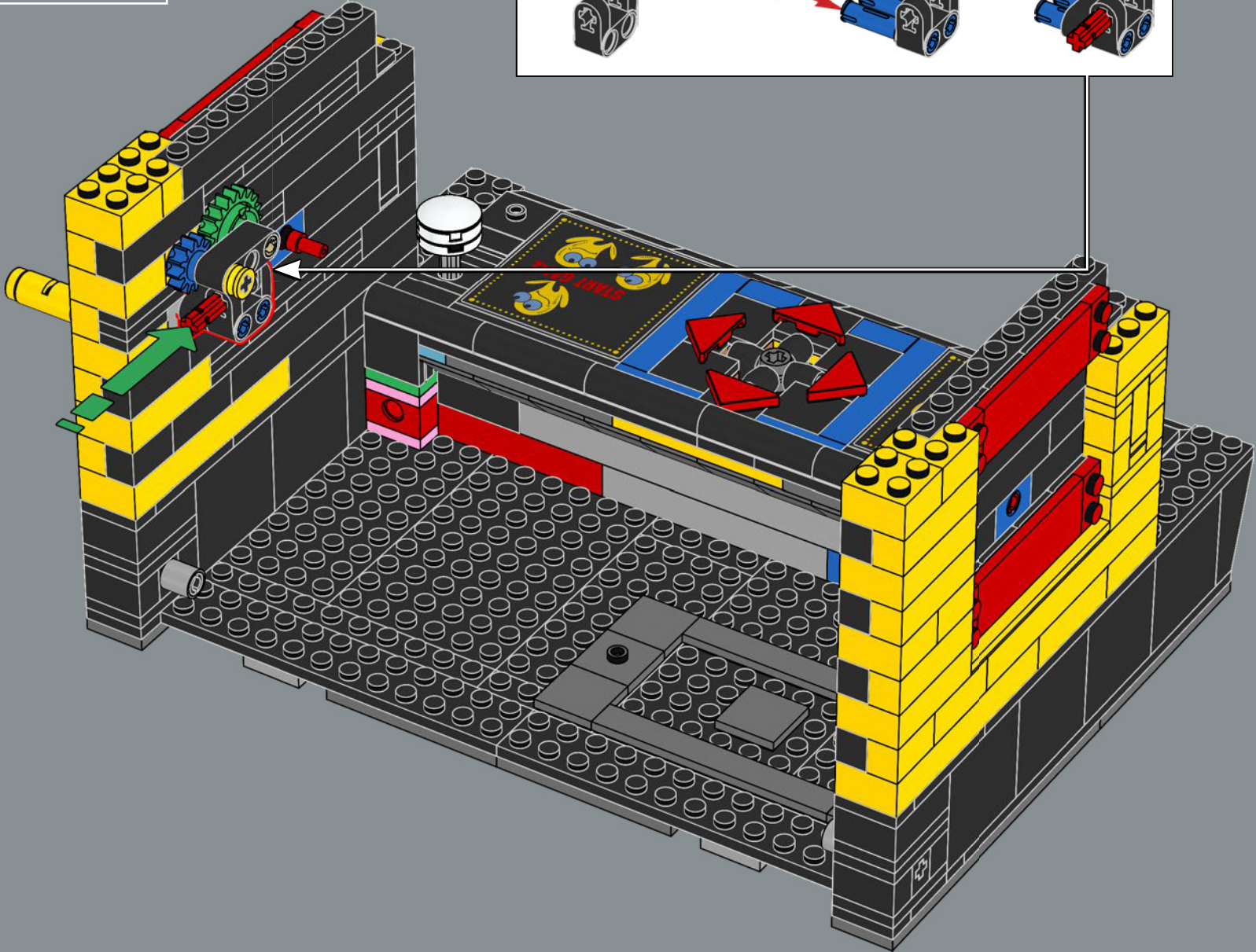
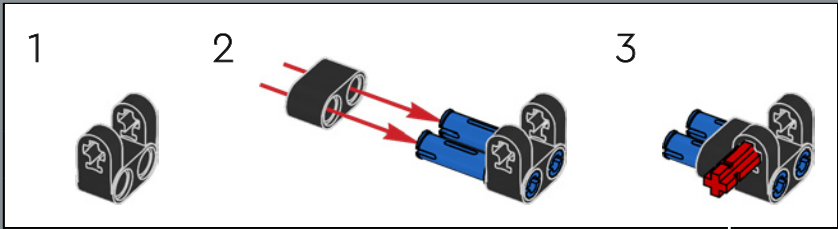

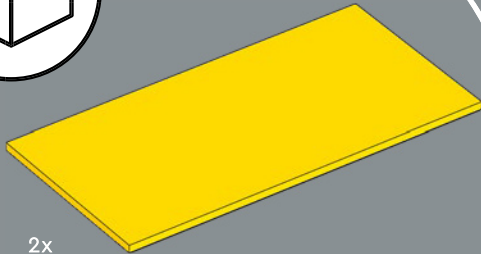
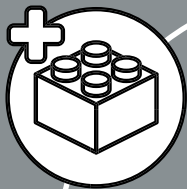

2x



6

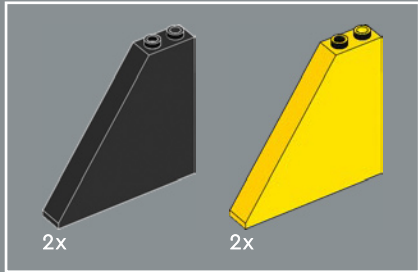
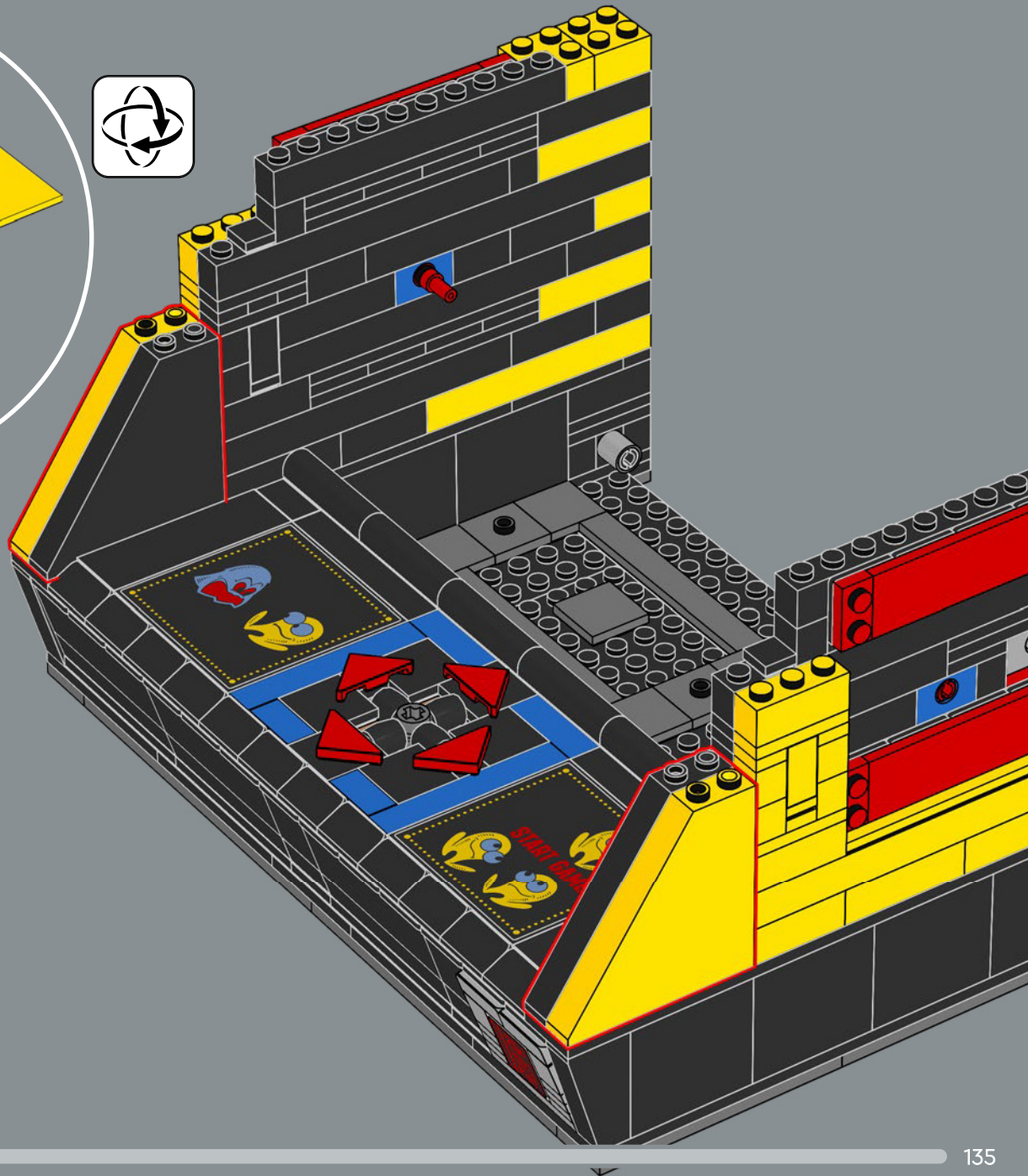

2x

2x

80

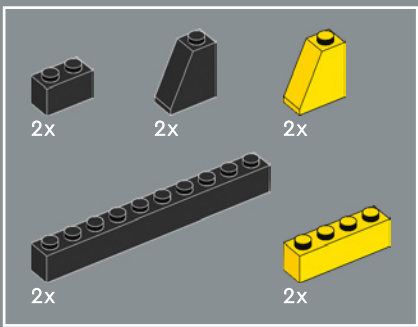

81

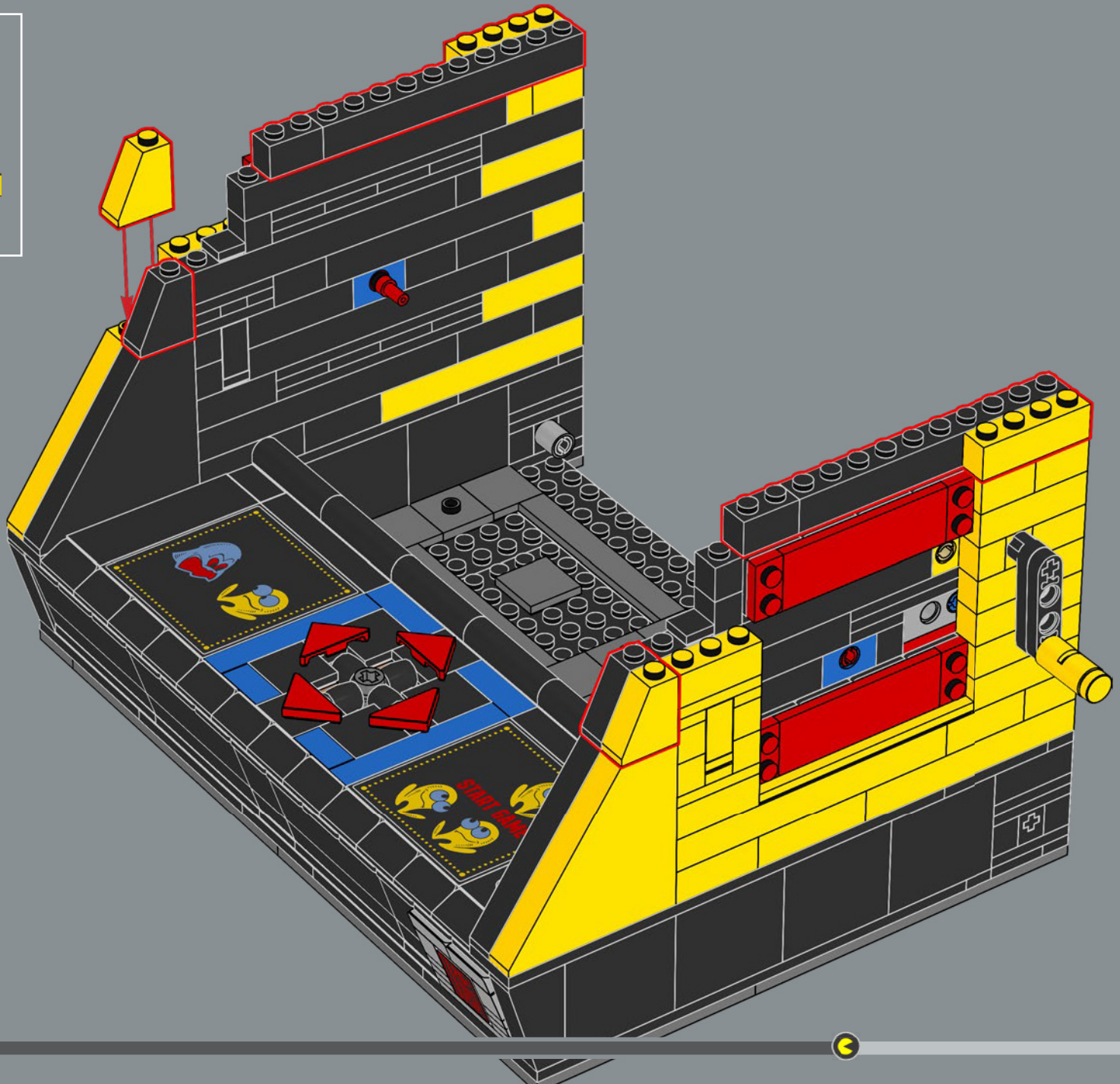





82

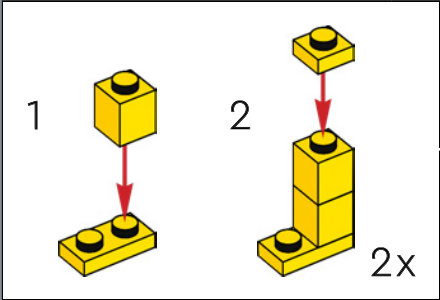
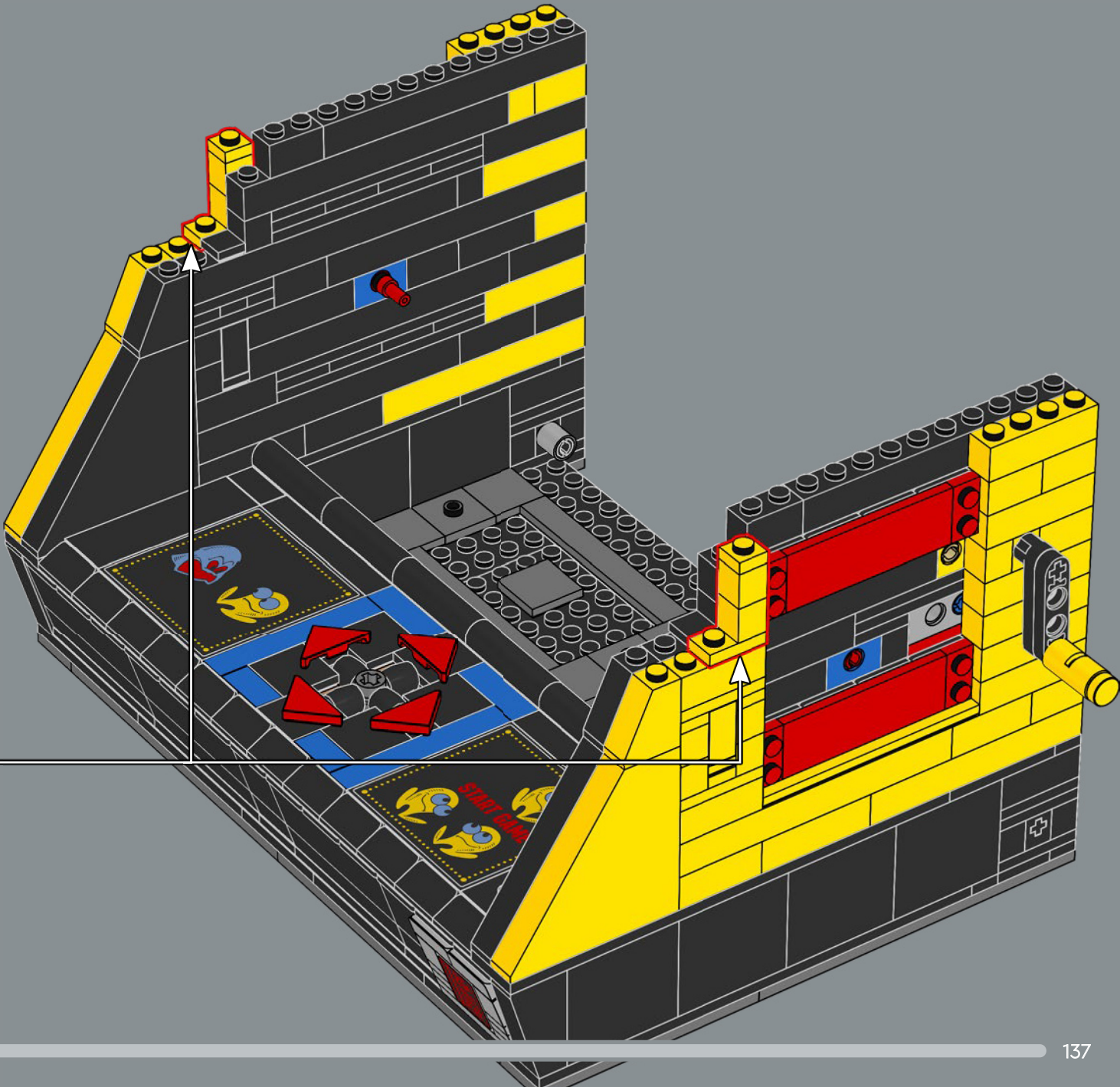

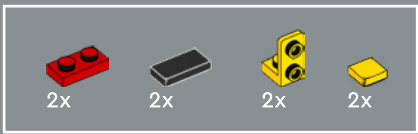

83

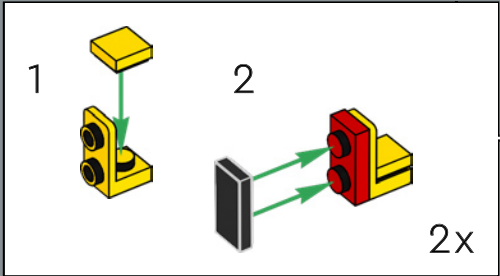
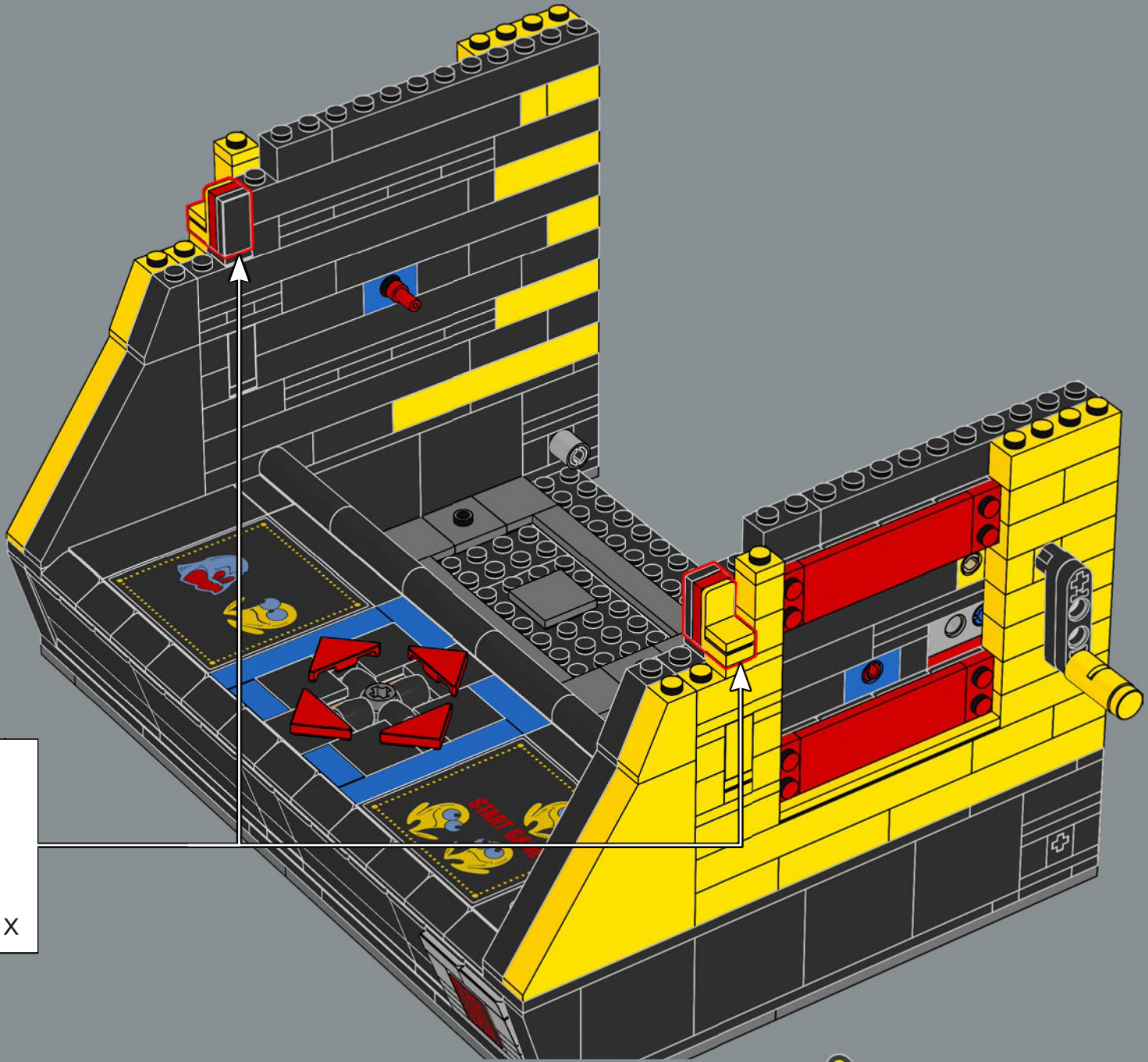

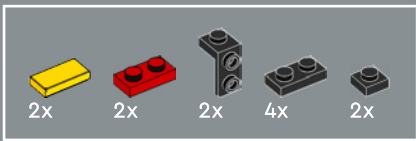

84

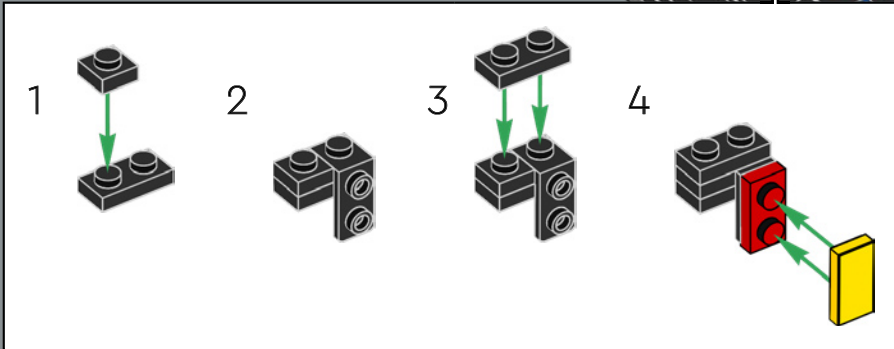
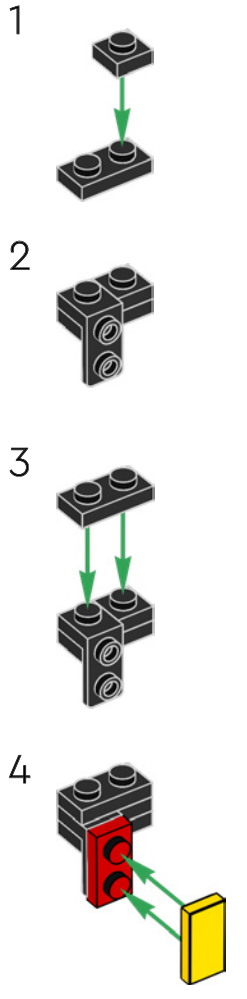
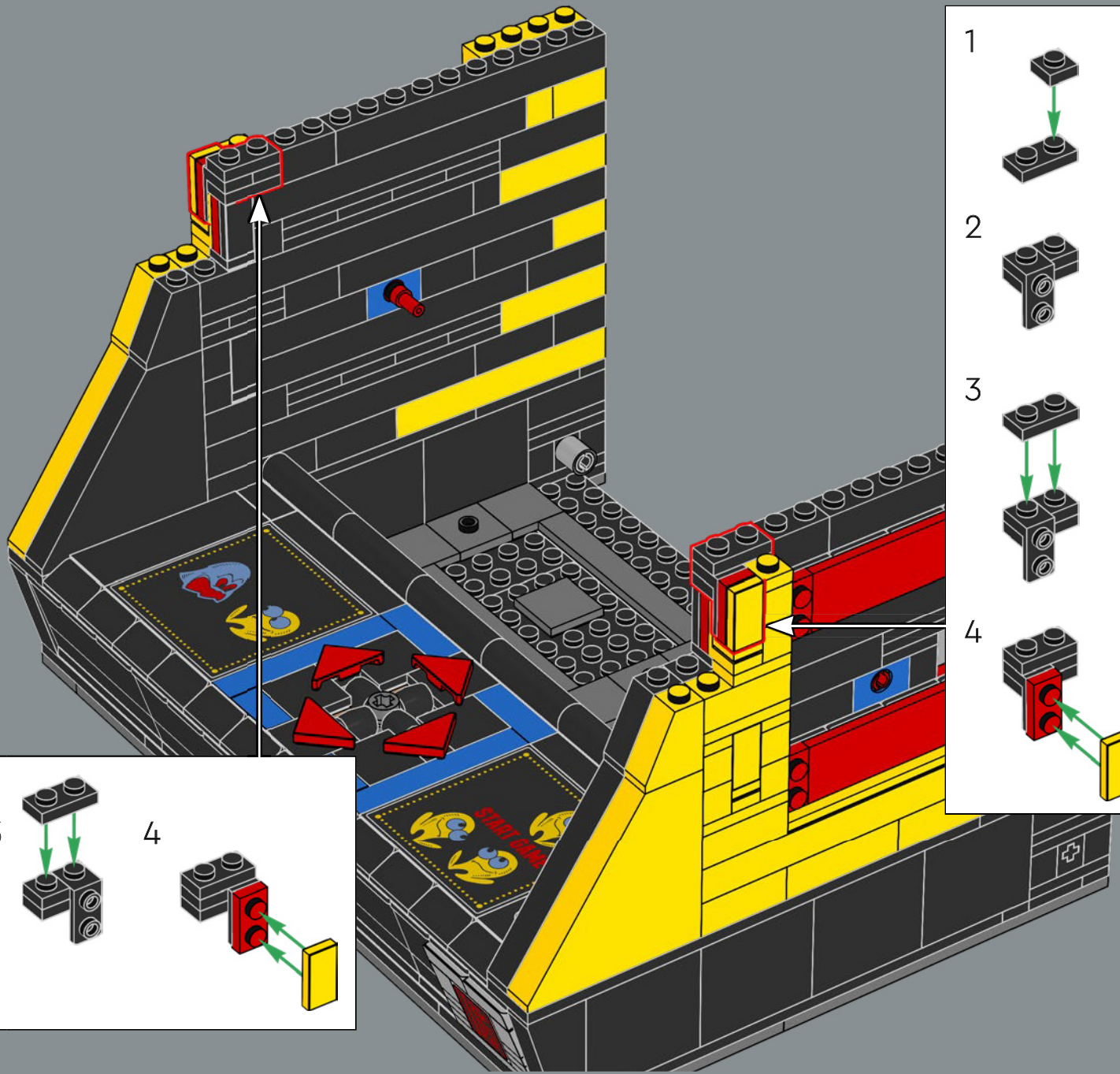

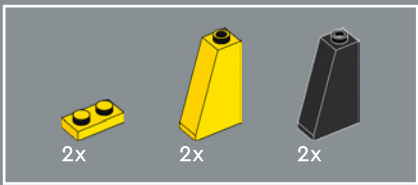

85

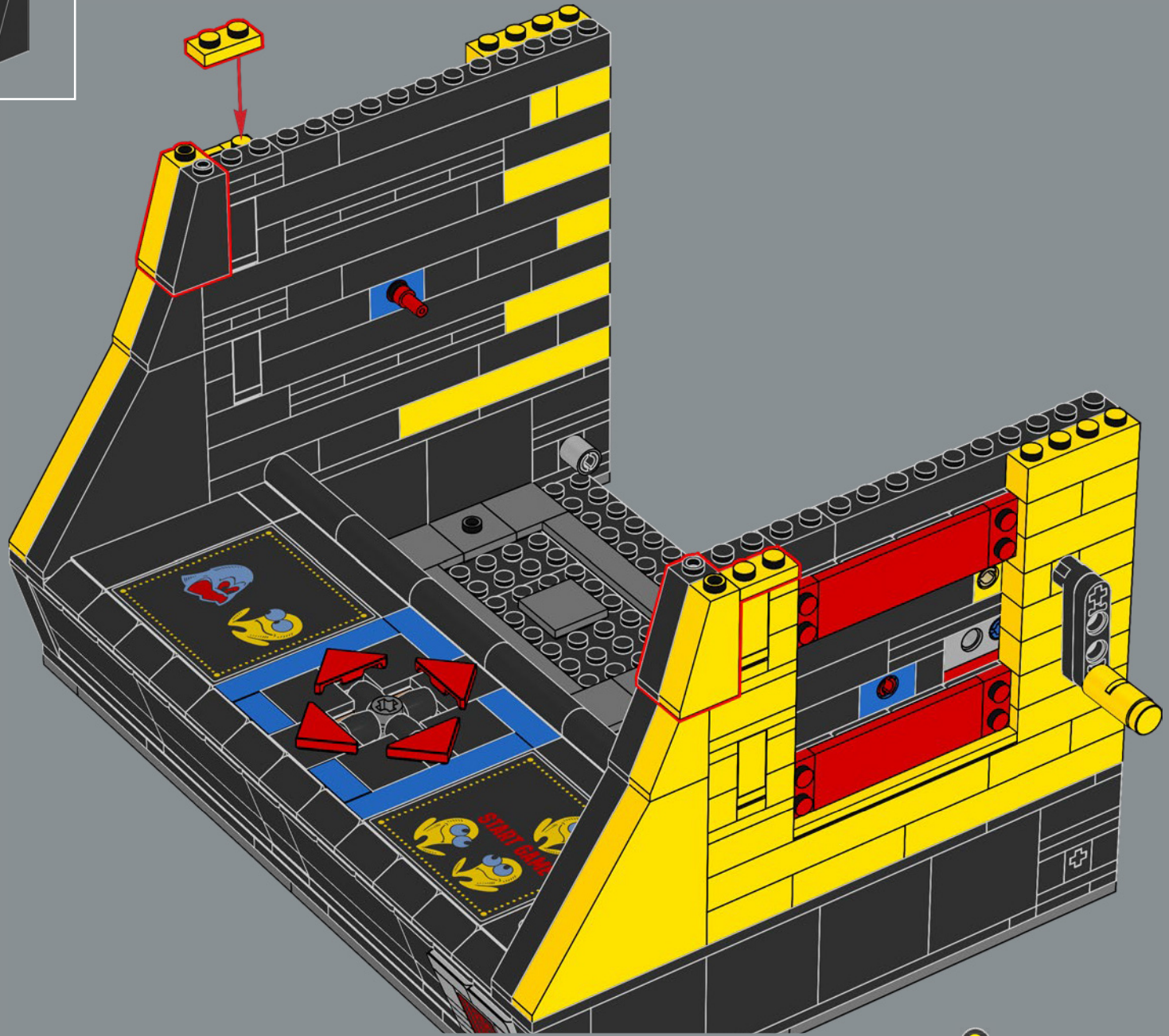

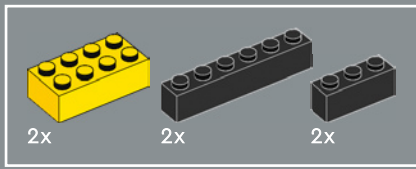

86

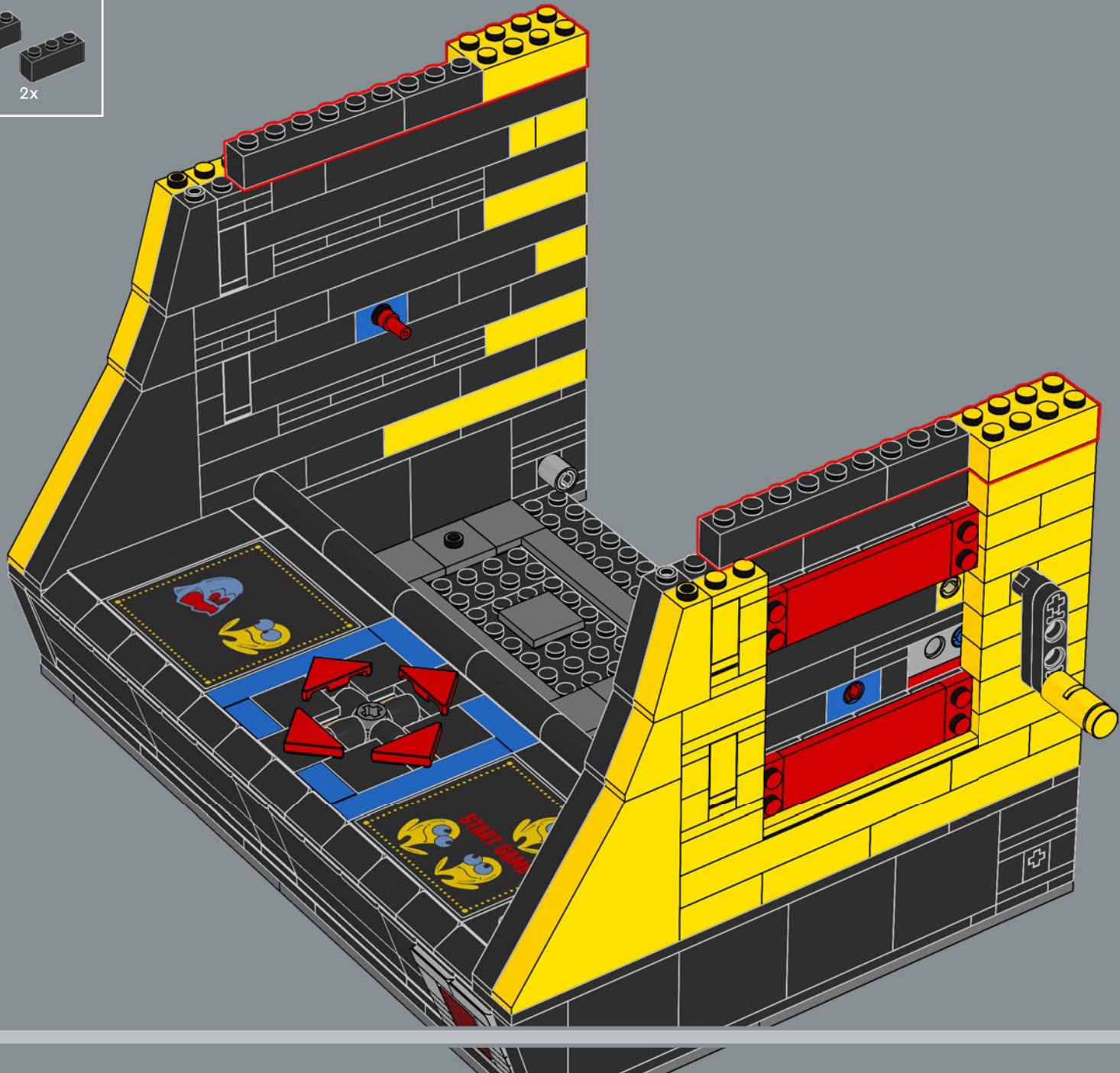

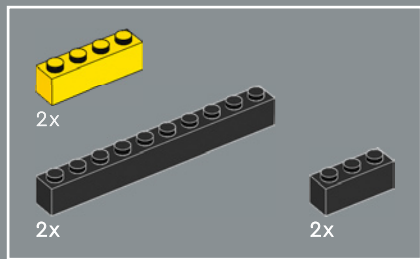

87

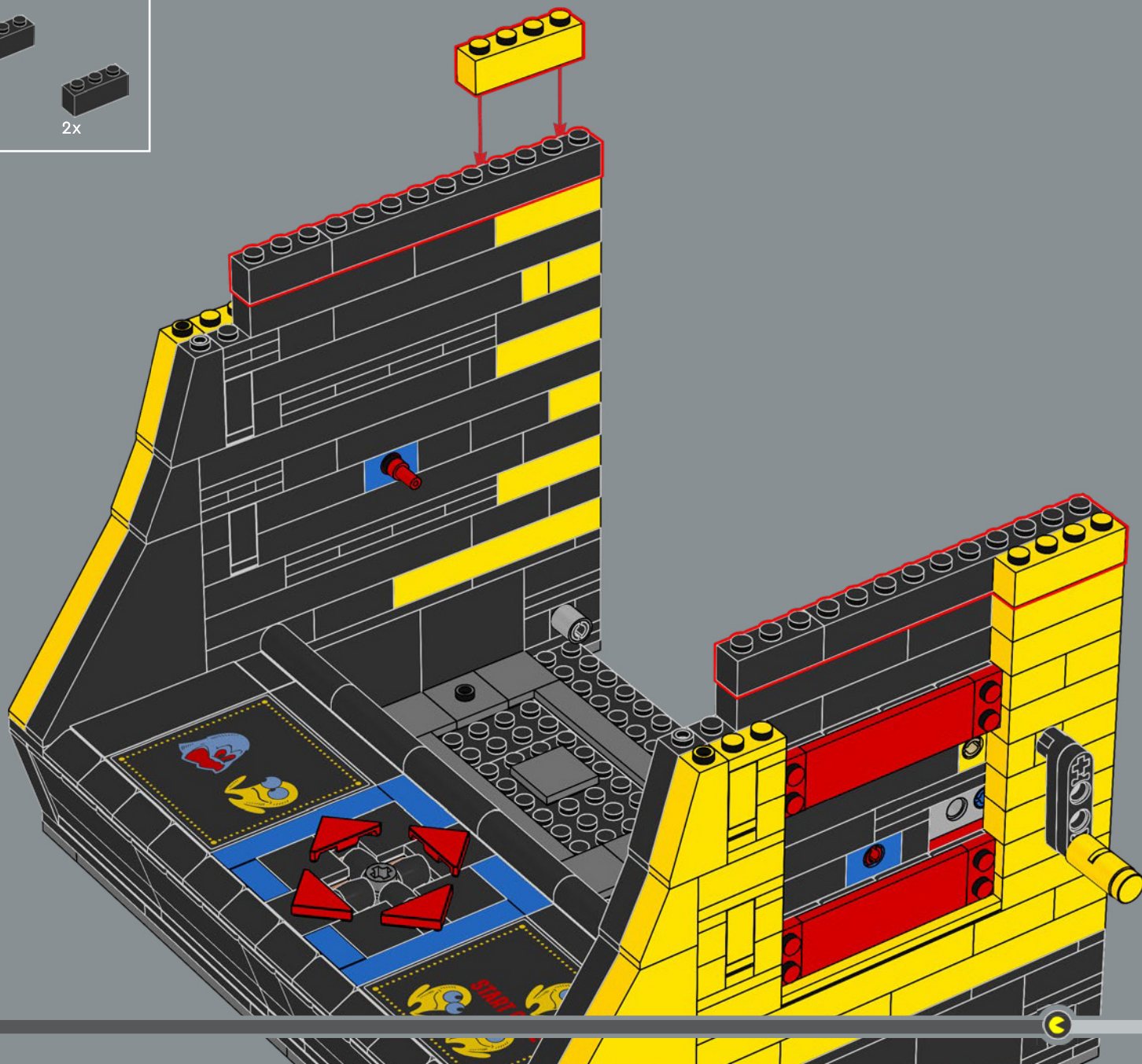

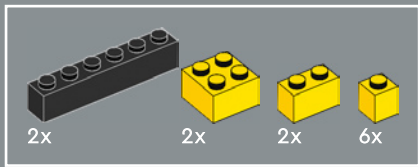

88

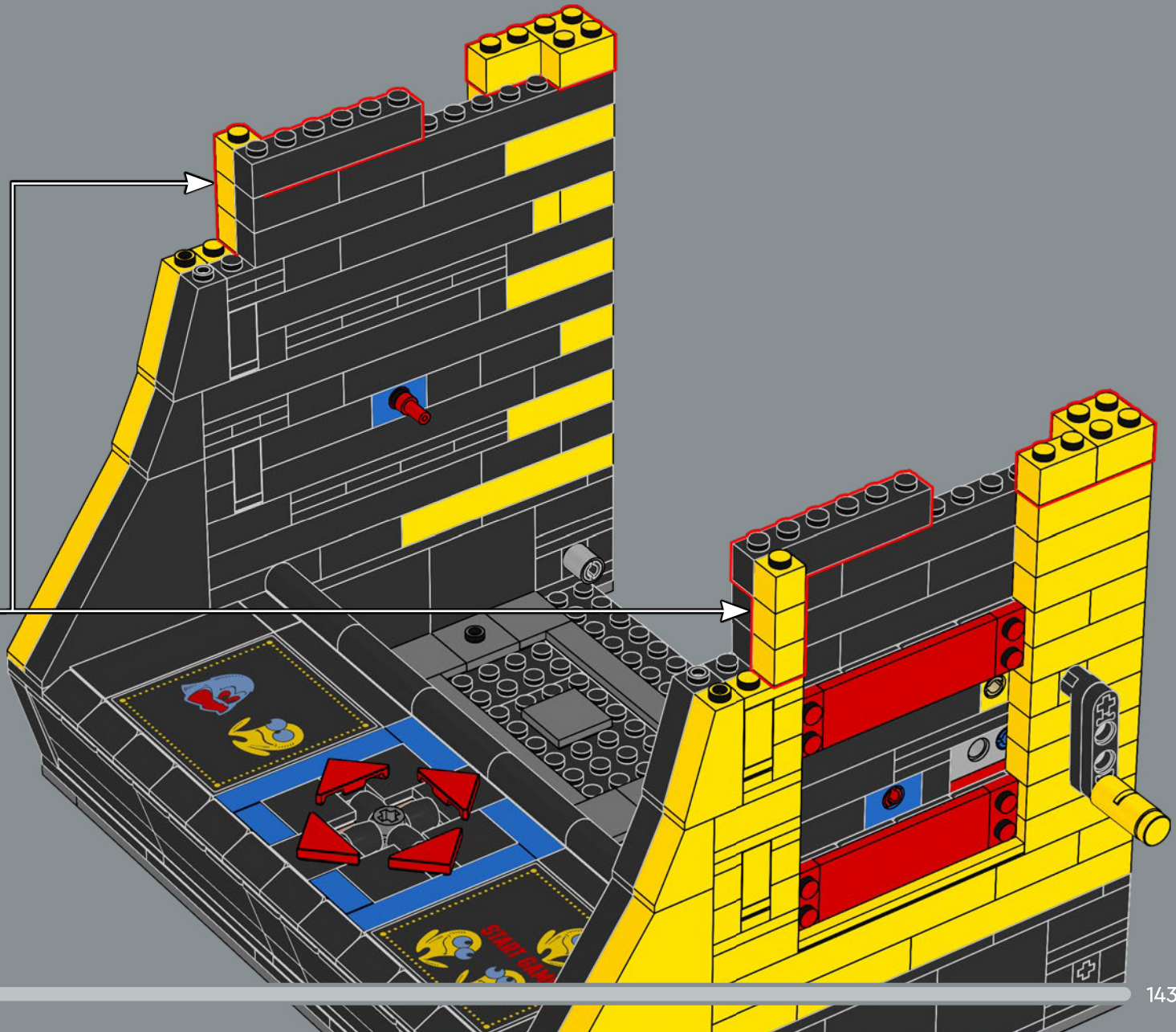
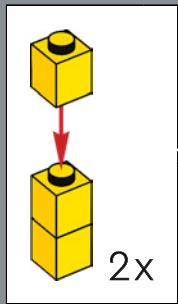

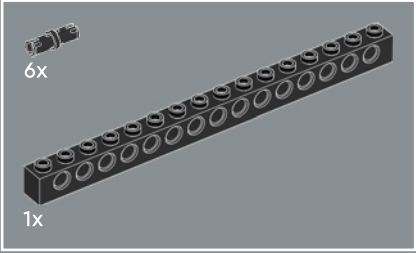
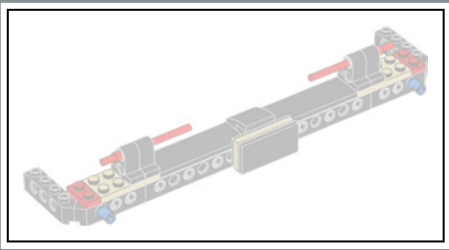

89

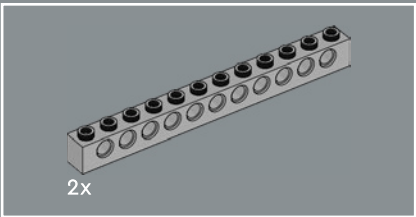
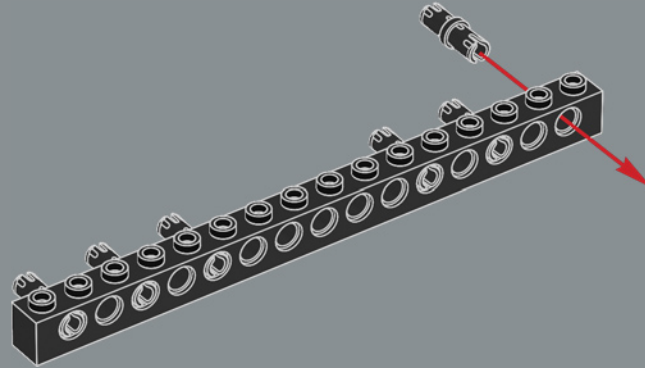

90

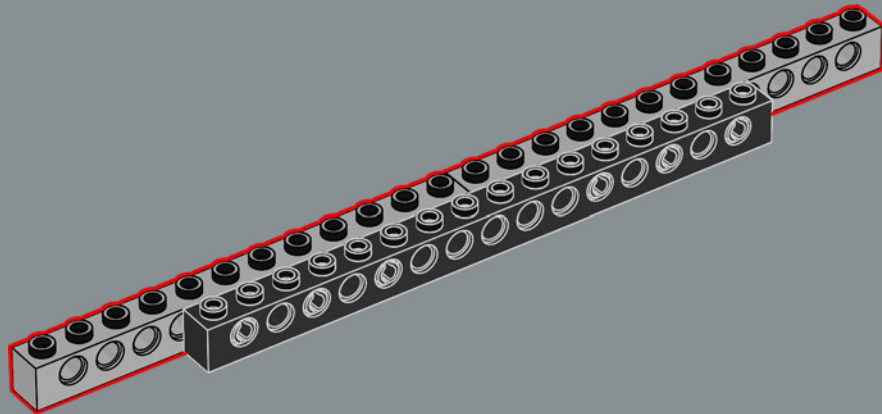





91

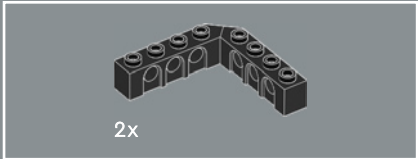
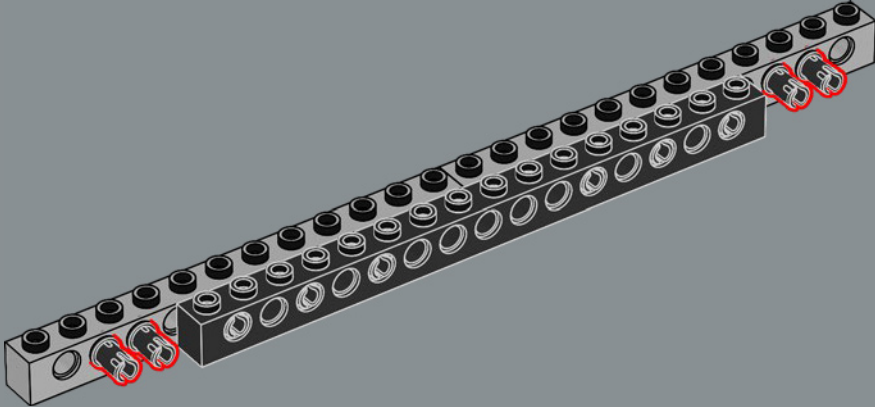

92

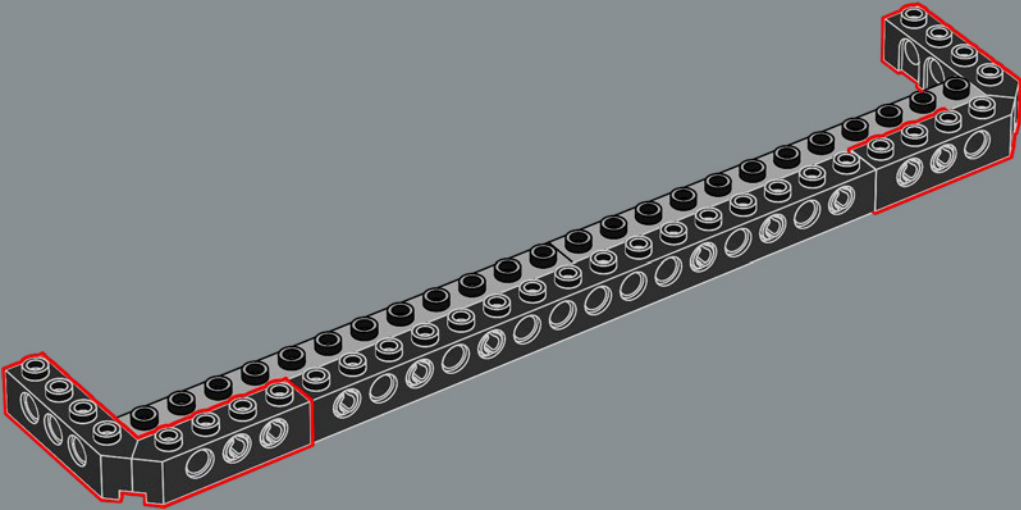



93

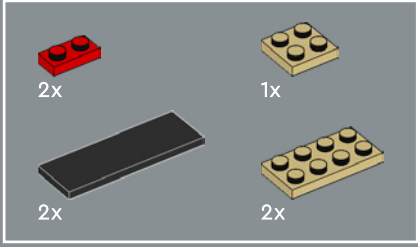
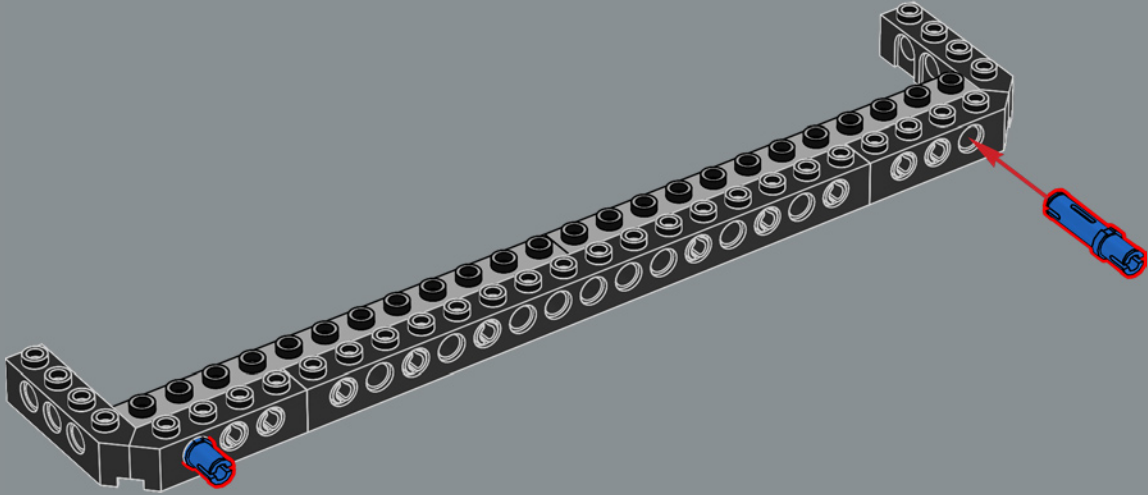

94

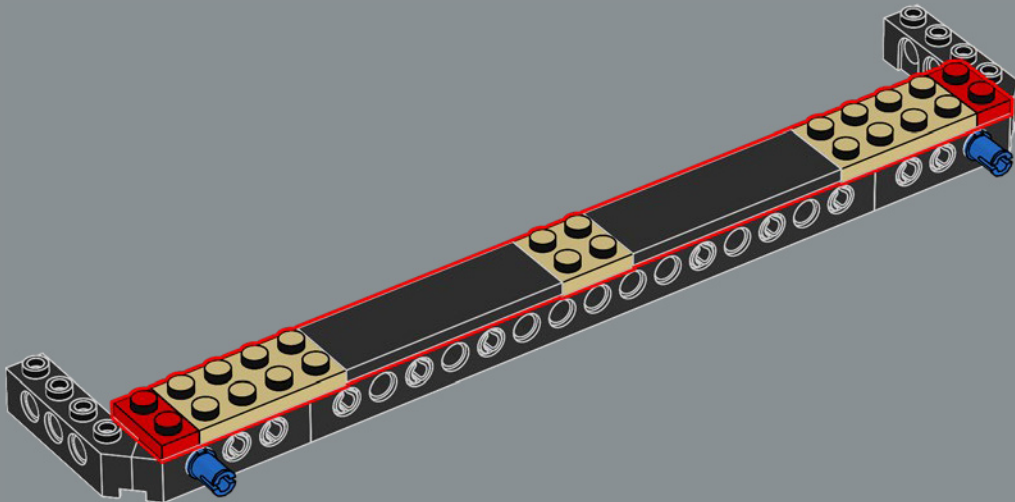

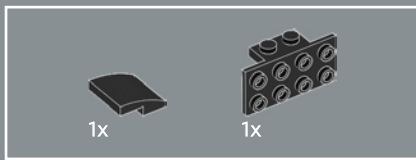

95

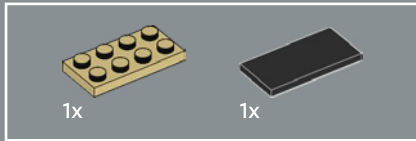
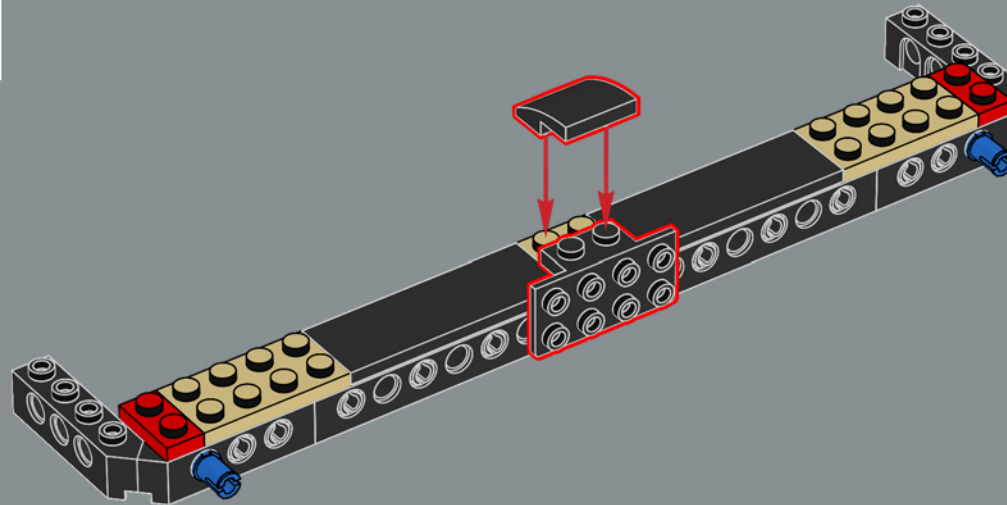

96

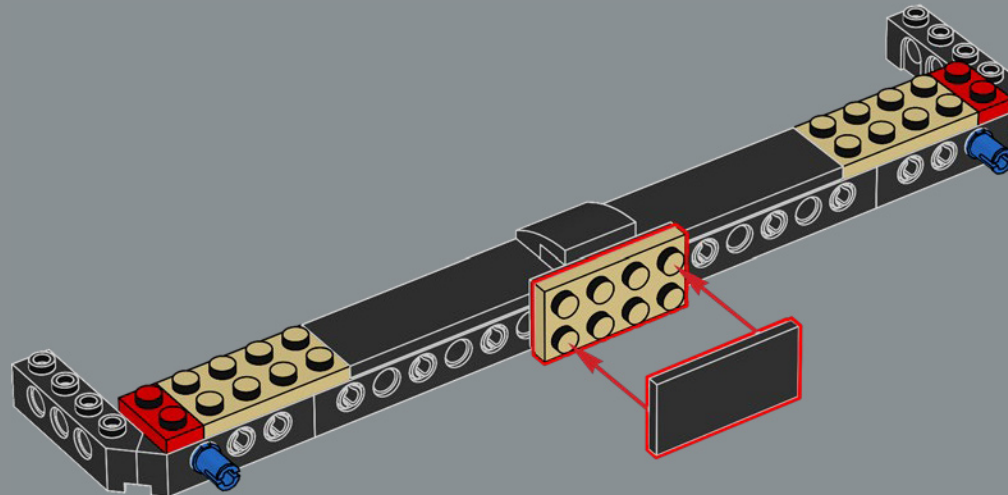

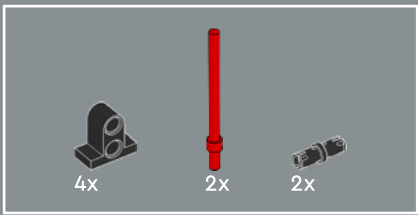

97

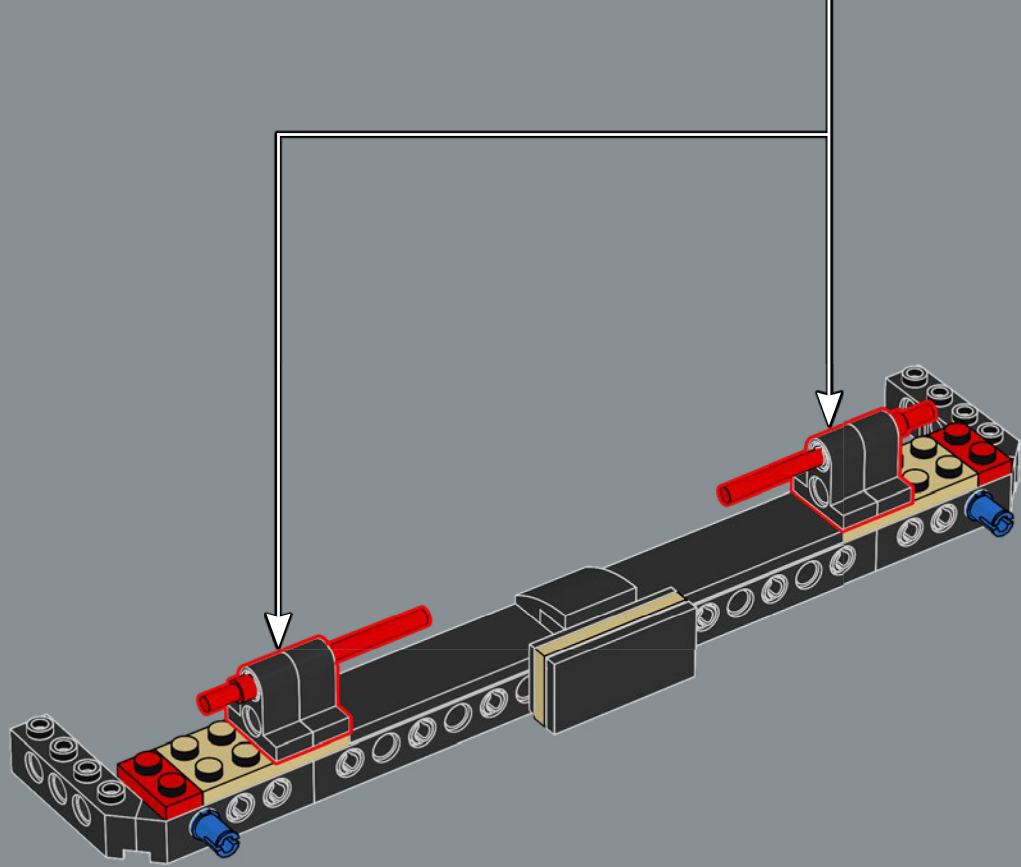
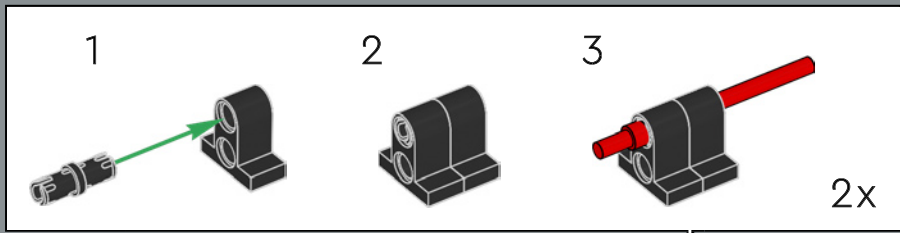

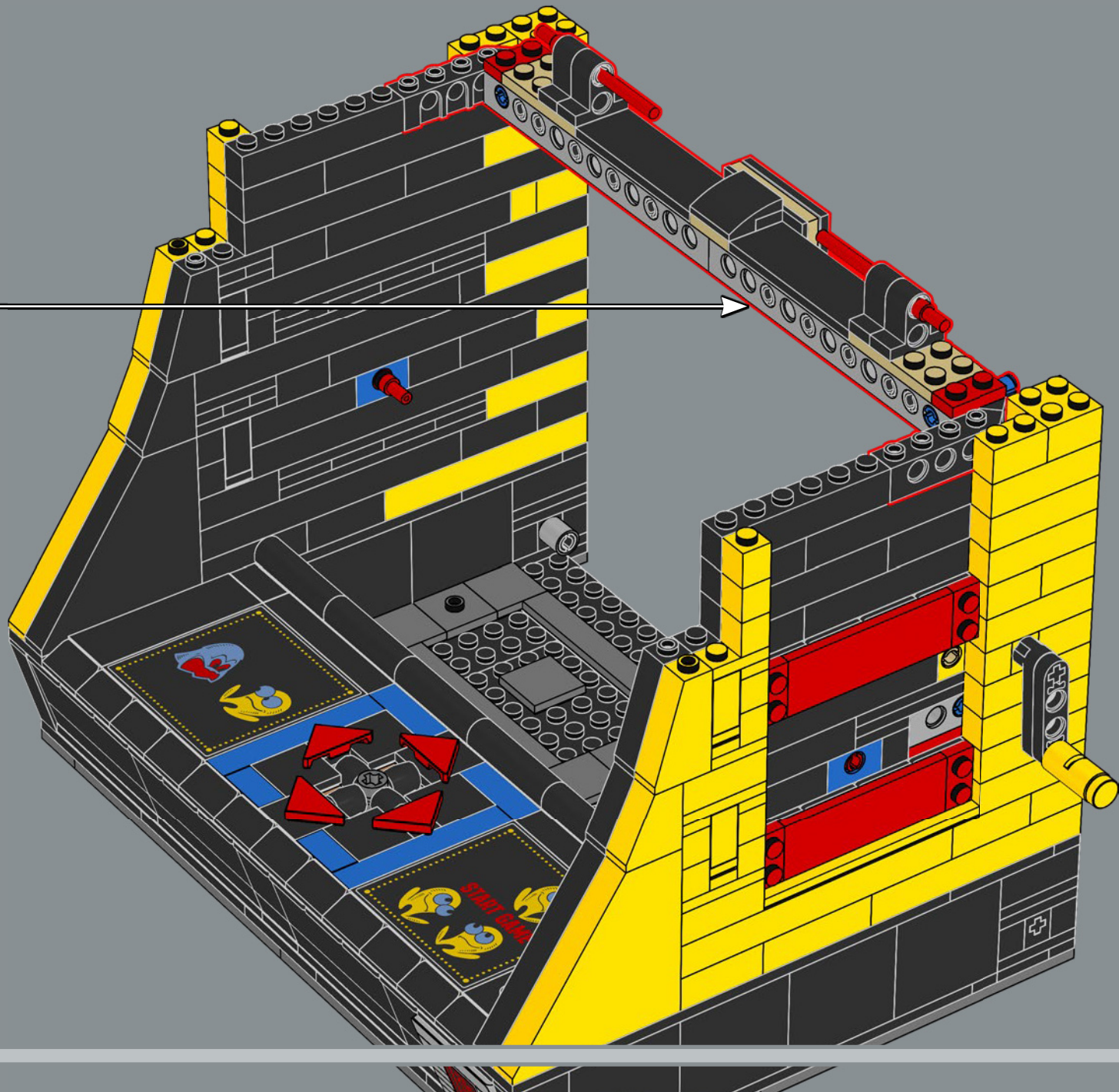

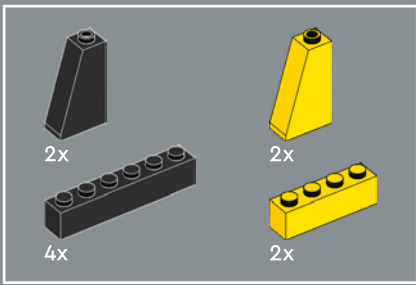

99

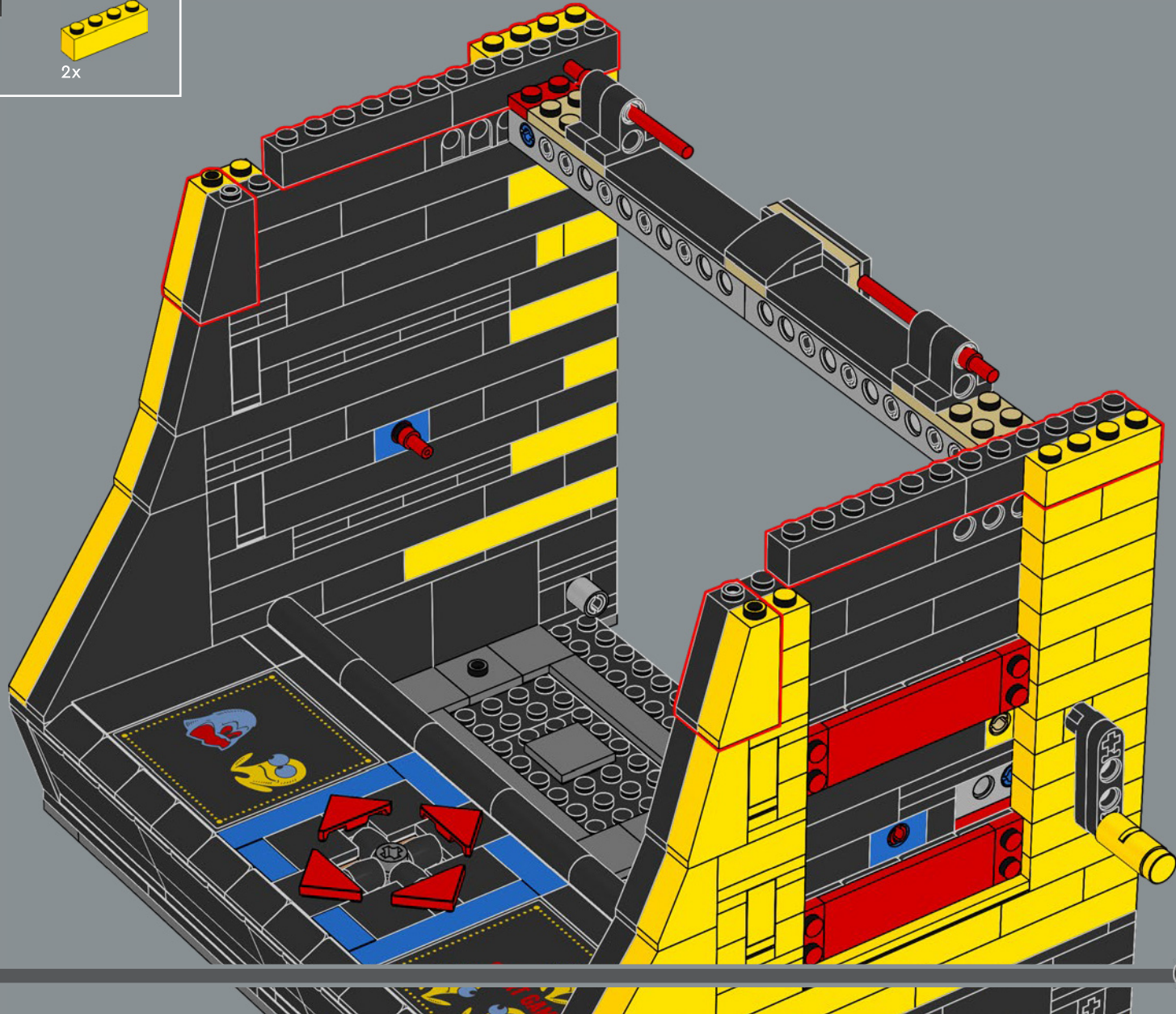

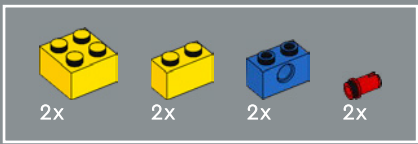

100

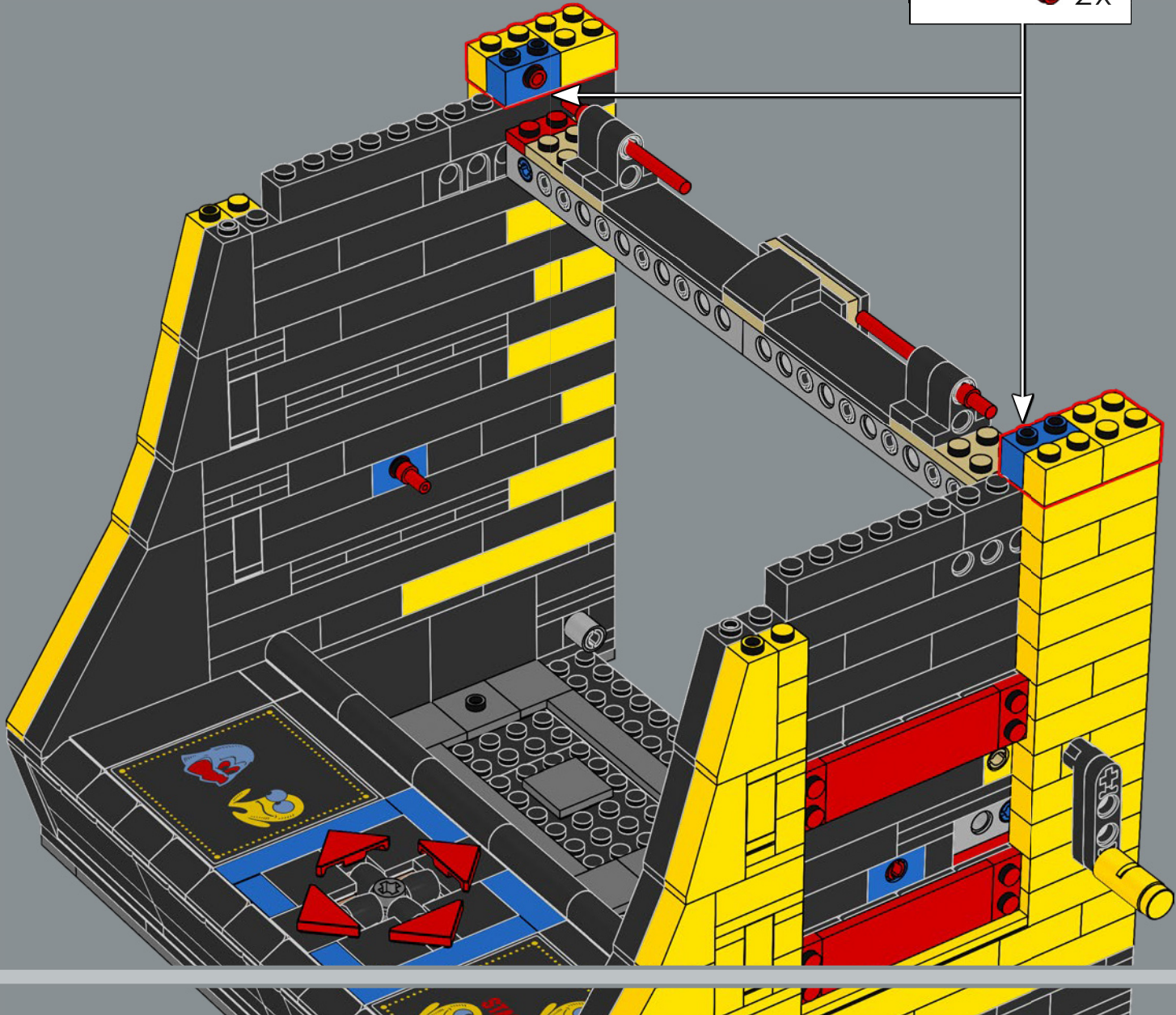
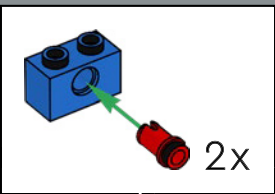

101

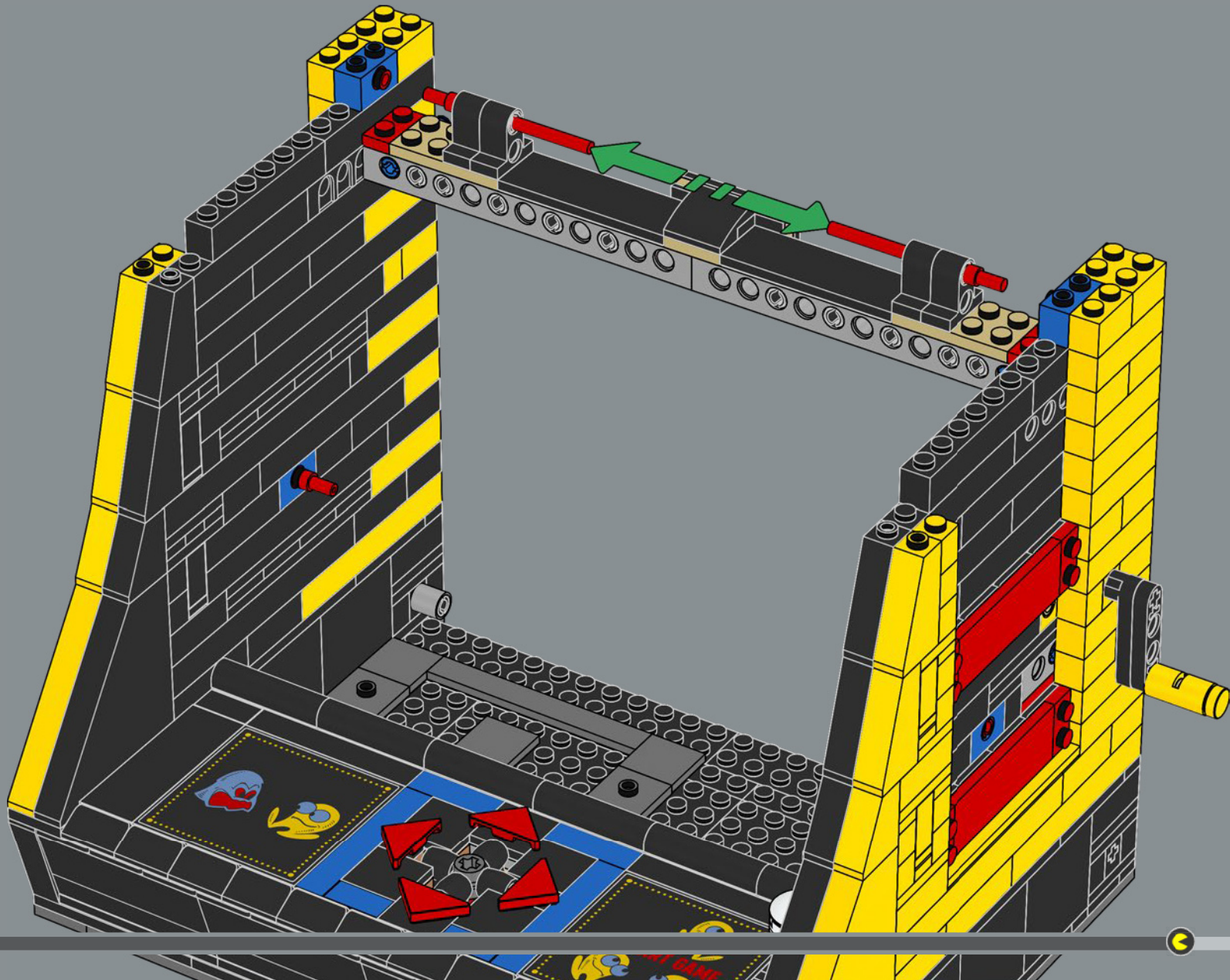



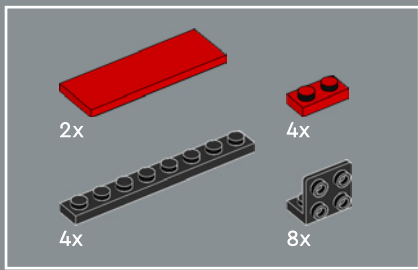

102

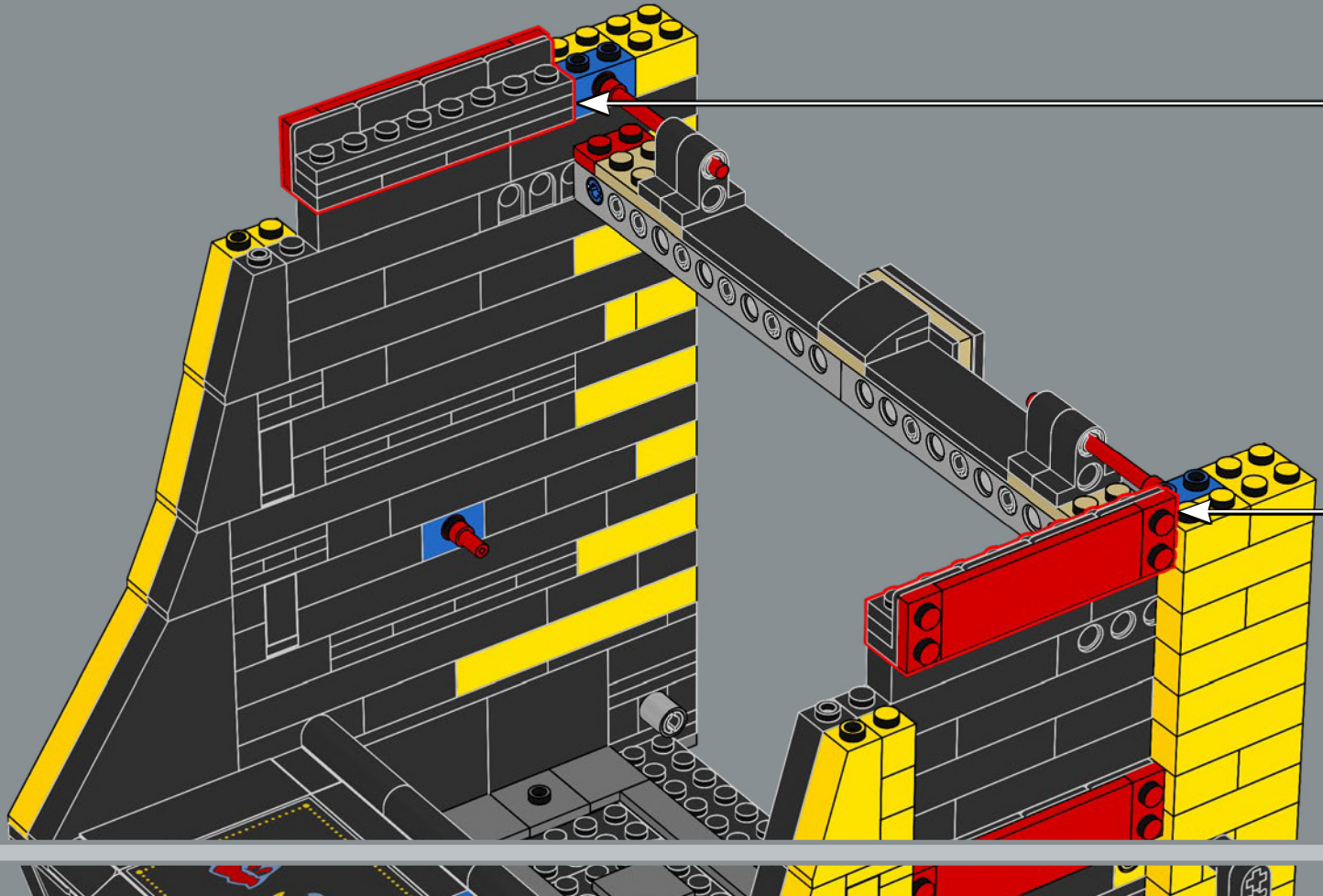
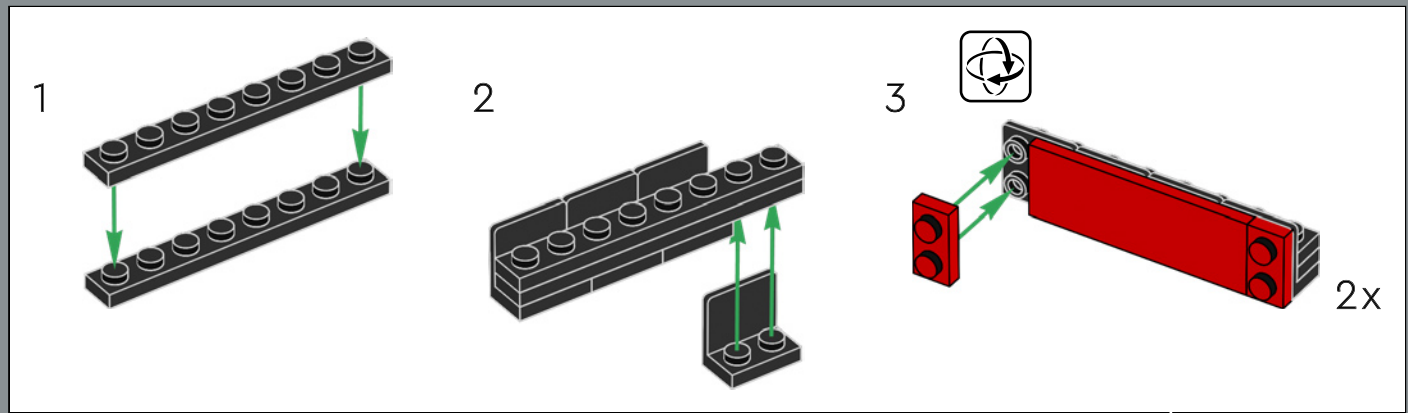

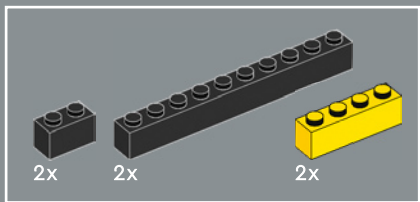

103

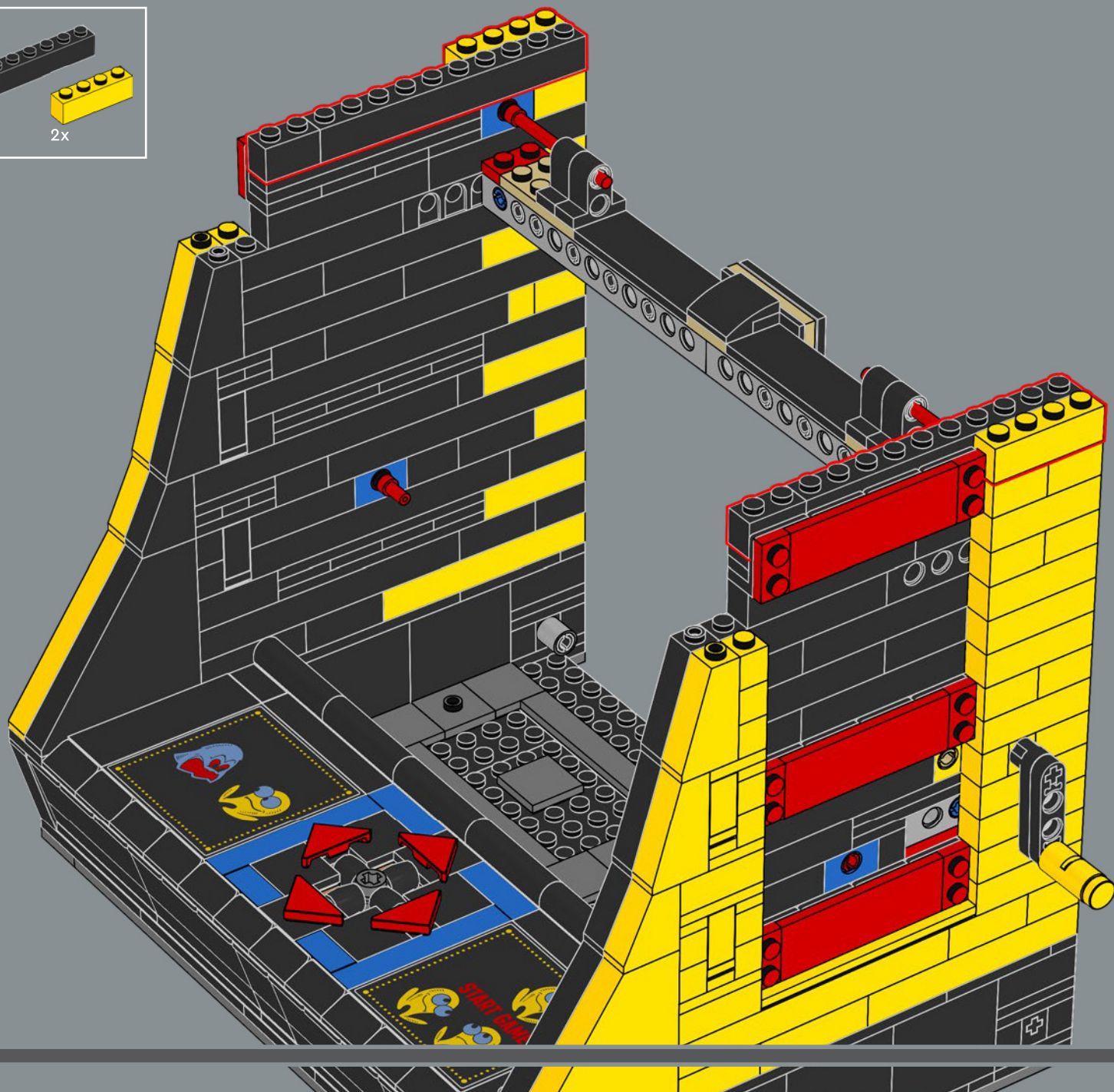

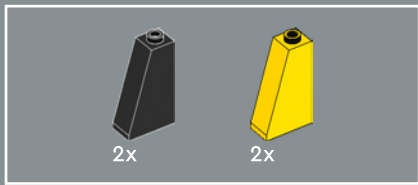

104

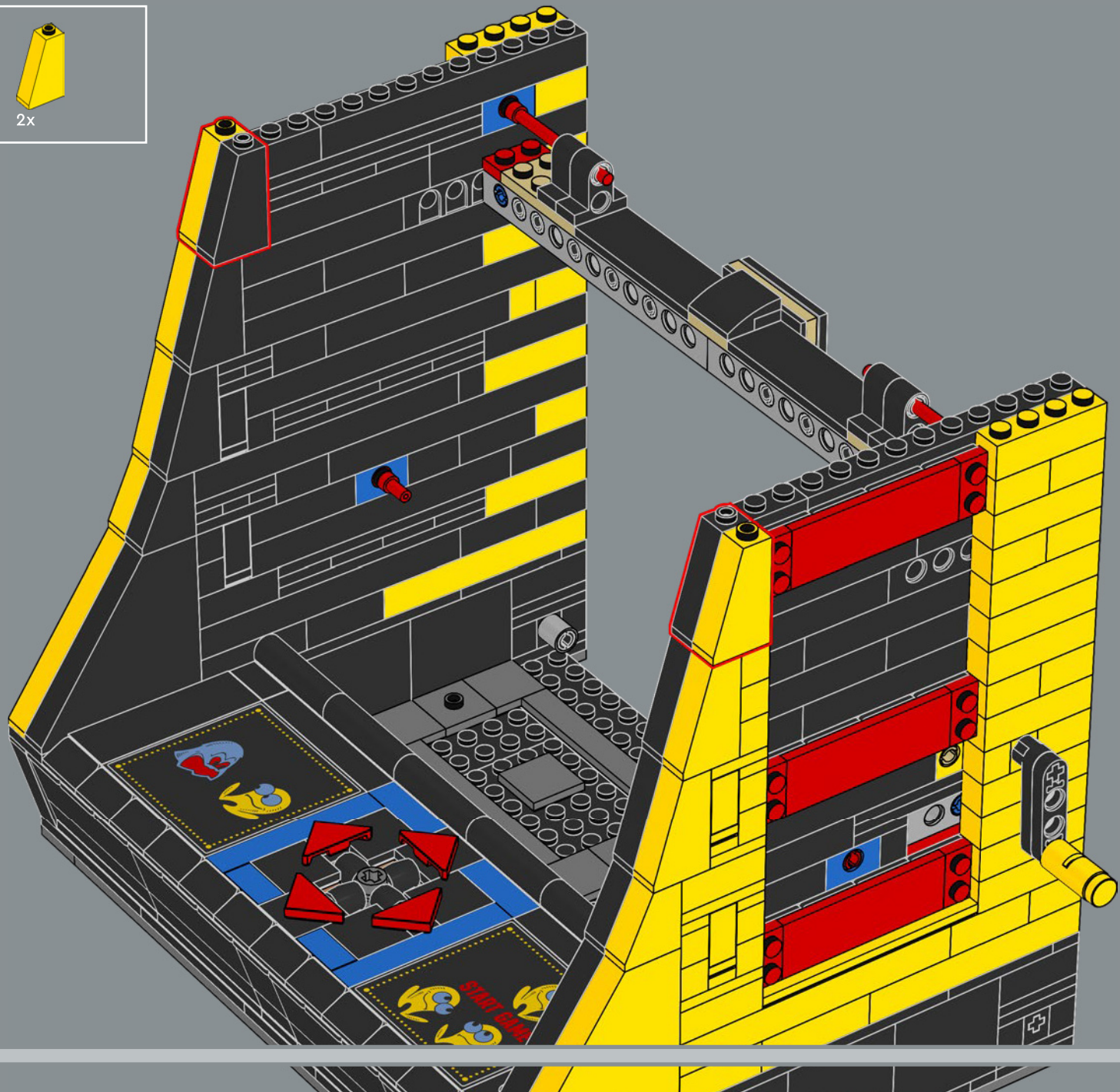

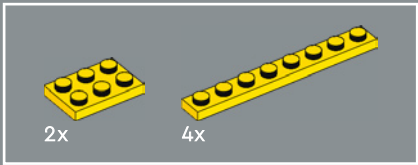

105

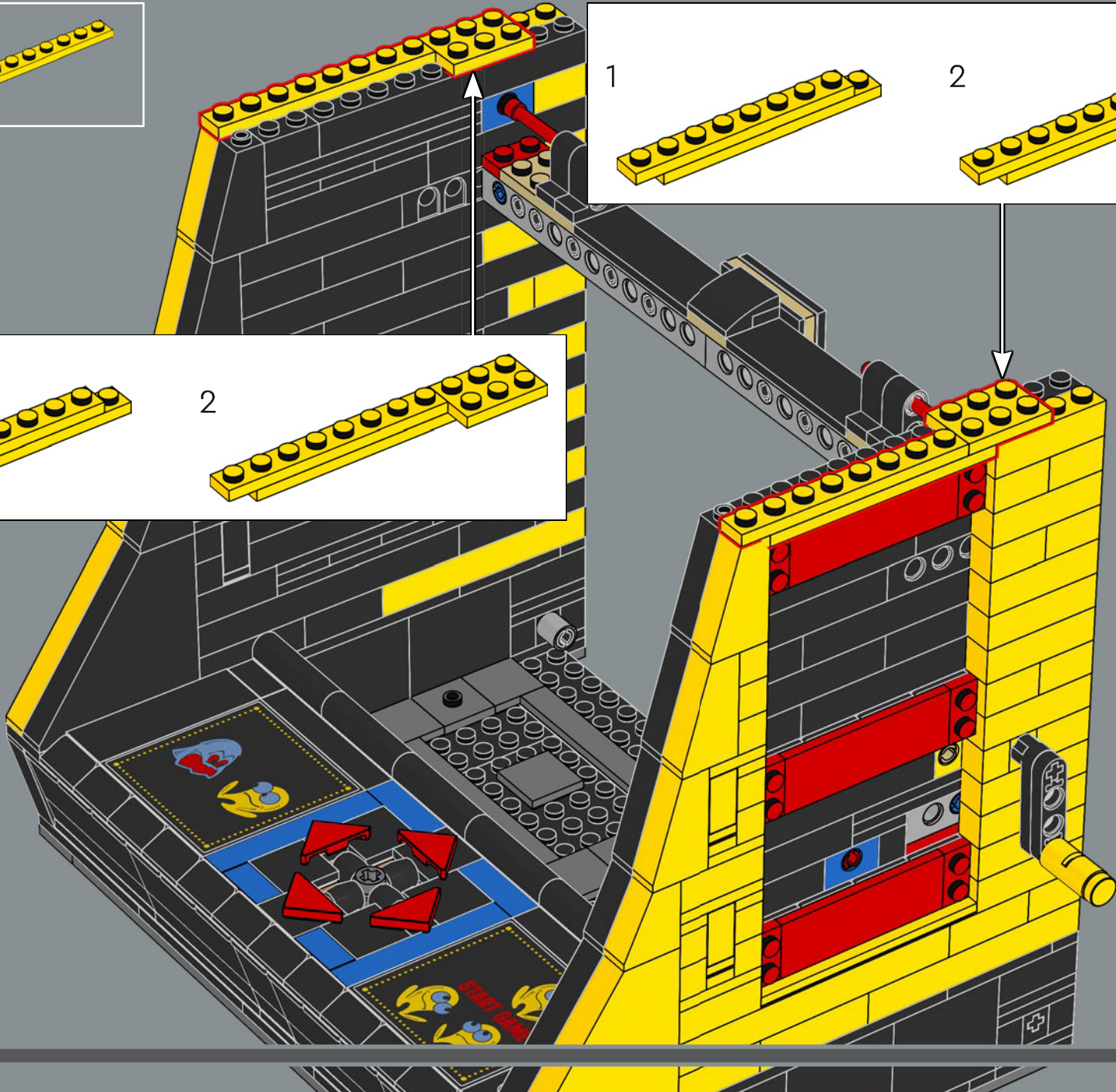
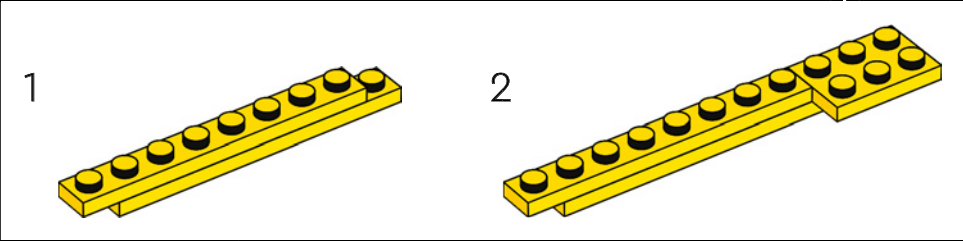
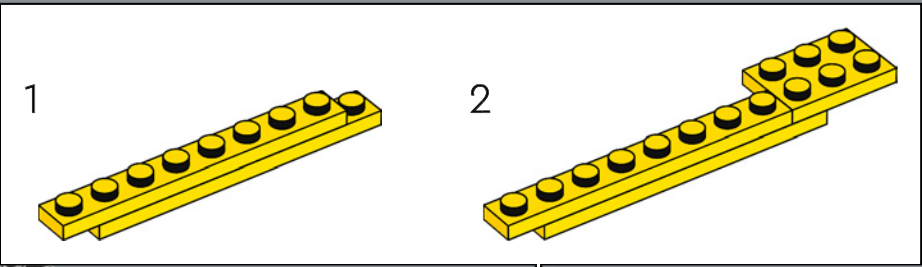

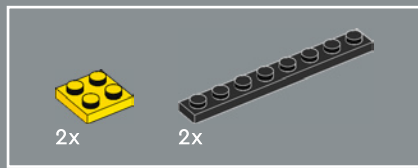

106

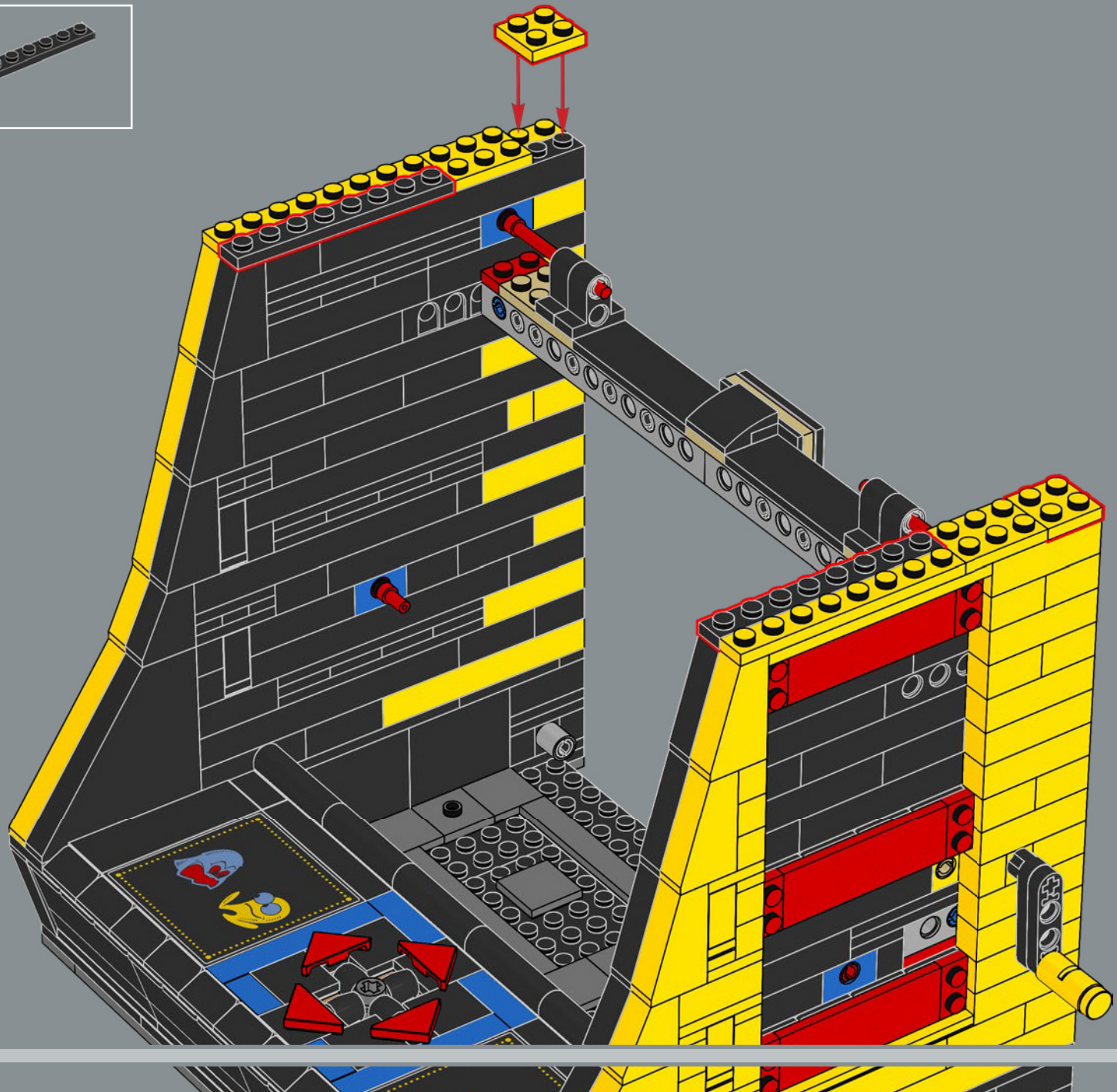

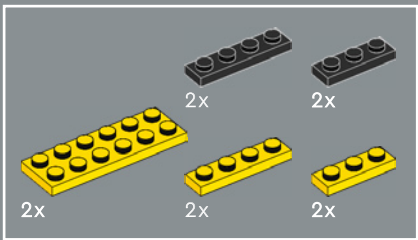

107

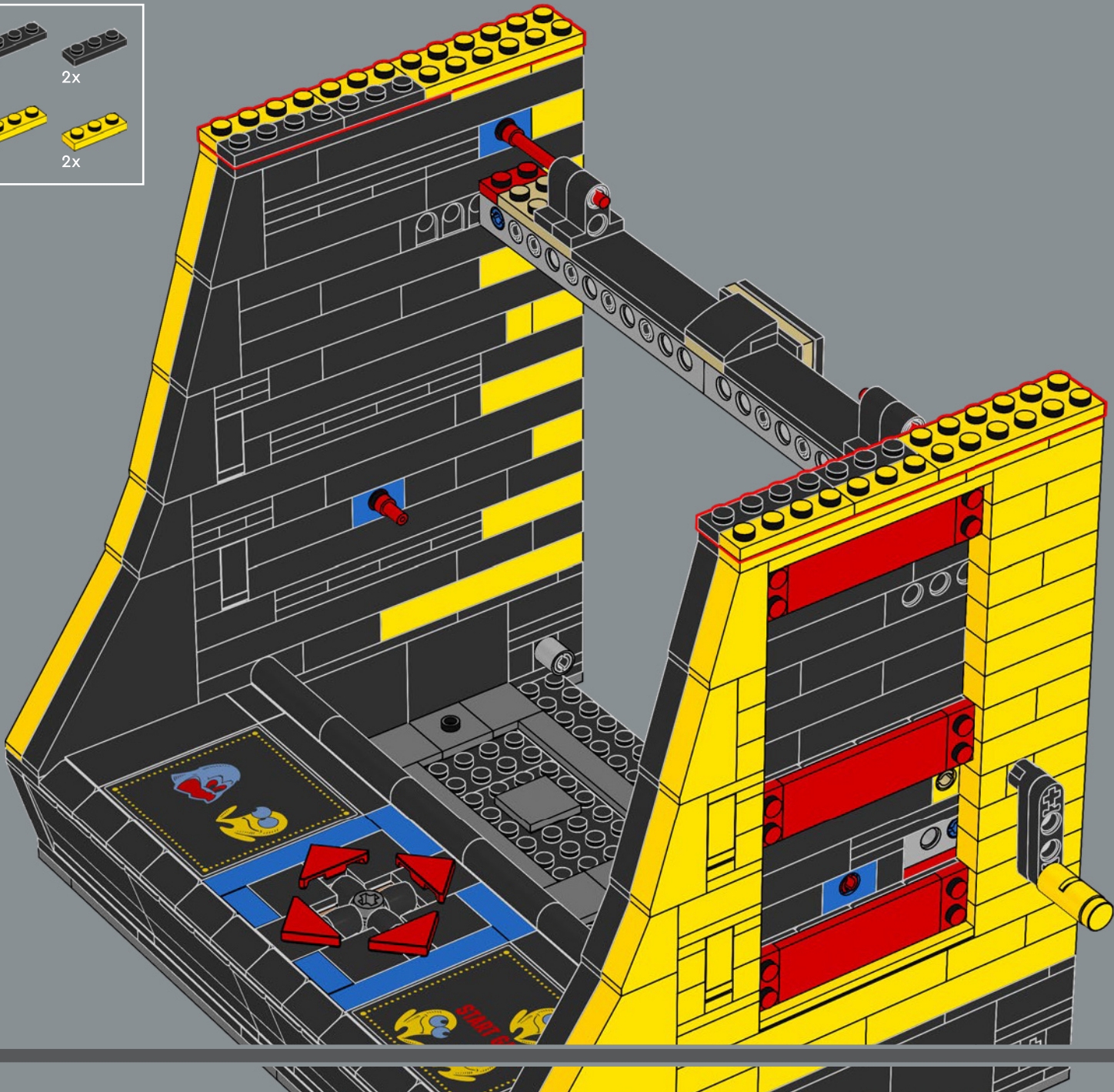



PAC-MAN the character was designed to look cheery and carefree, and spread joy to players.

Le personnage de PAC-MAN a été conçu pour avoir l'air jovial et insouciant, et pour être source de joie pour les joueurs.

El personaje de PAC-MAN se diseñó para que tuviera un aspecto jovial y despreocupado, y para que contagiara de alegría a los jugadores.

108

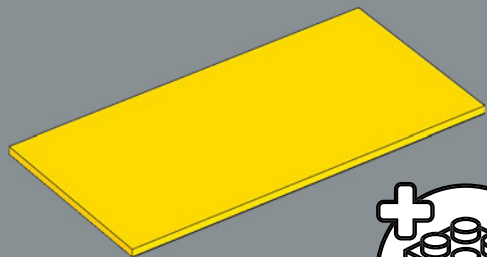

2x

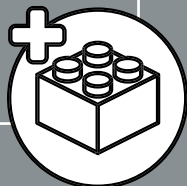

2

2x

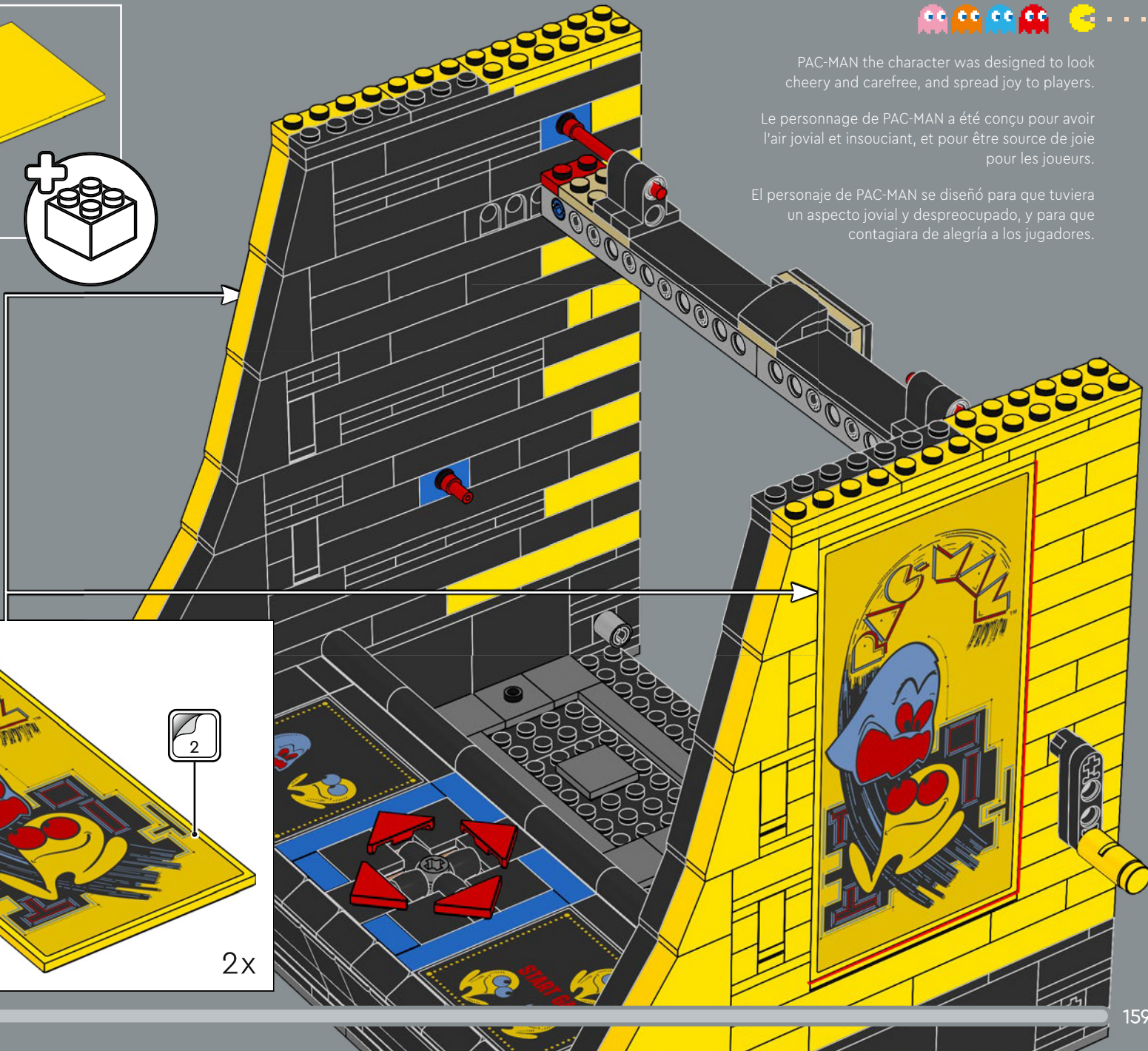

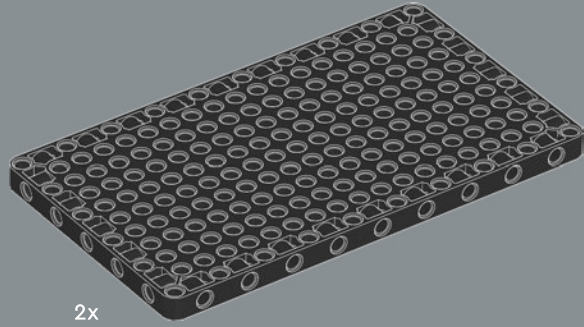
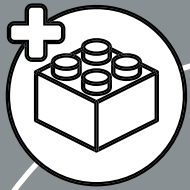

2x

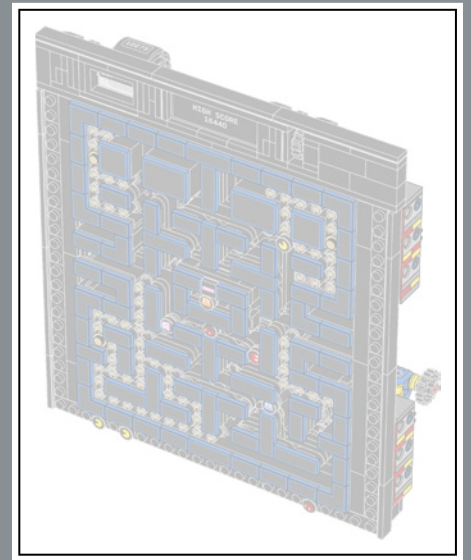



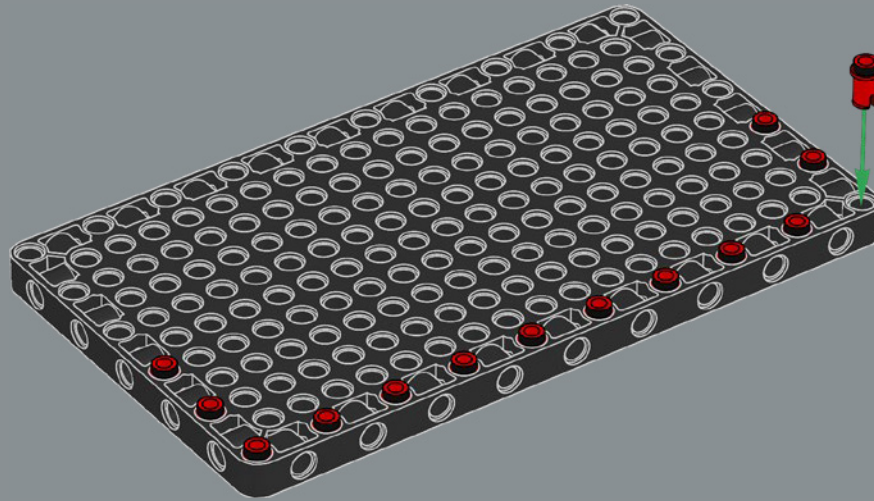
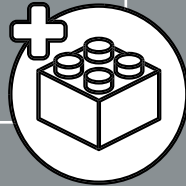
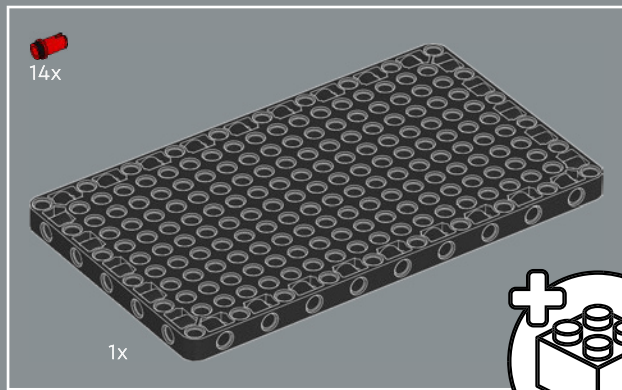

109

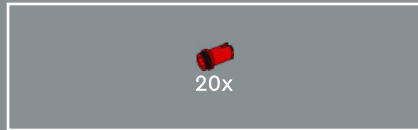

110

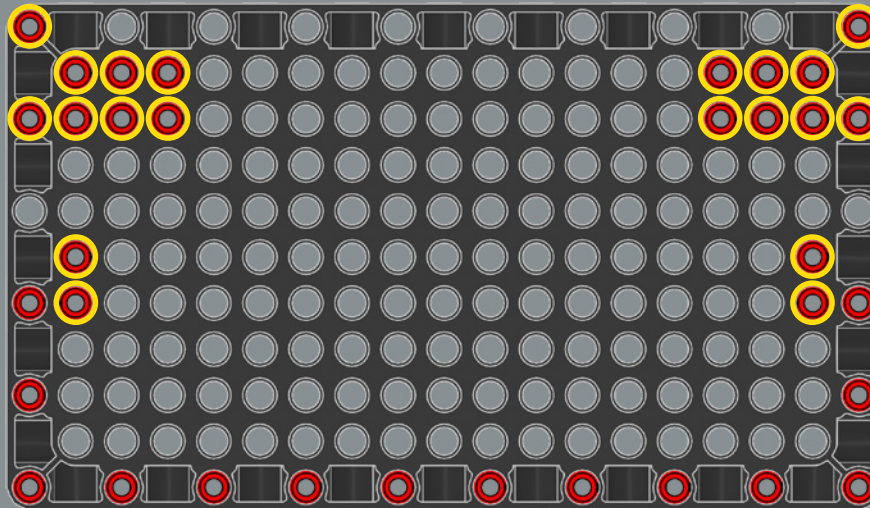

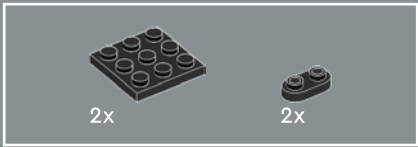

111

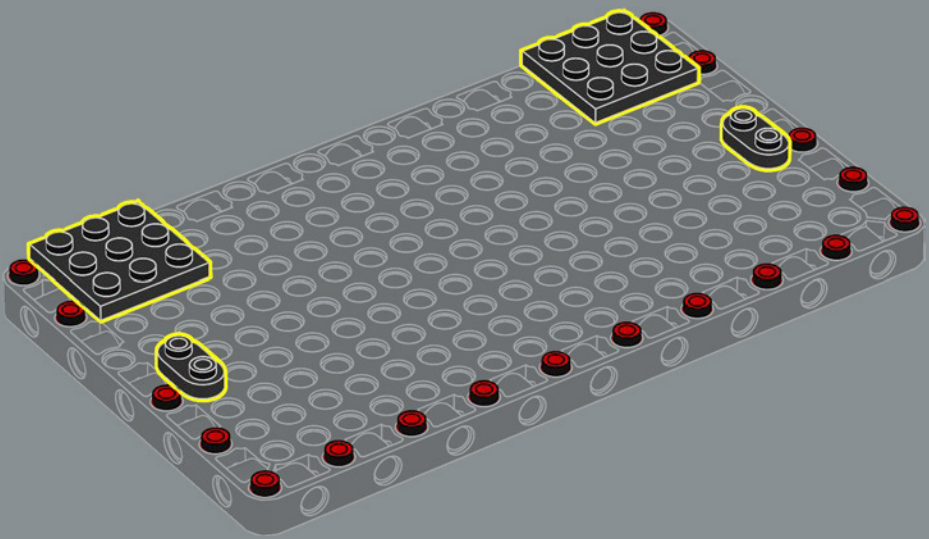

112

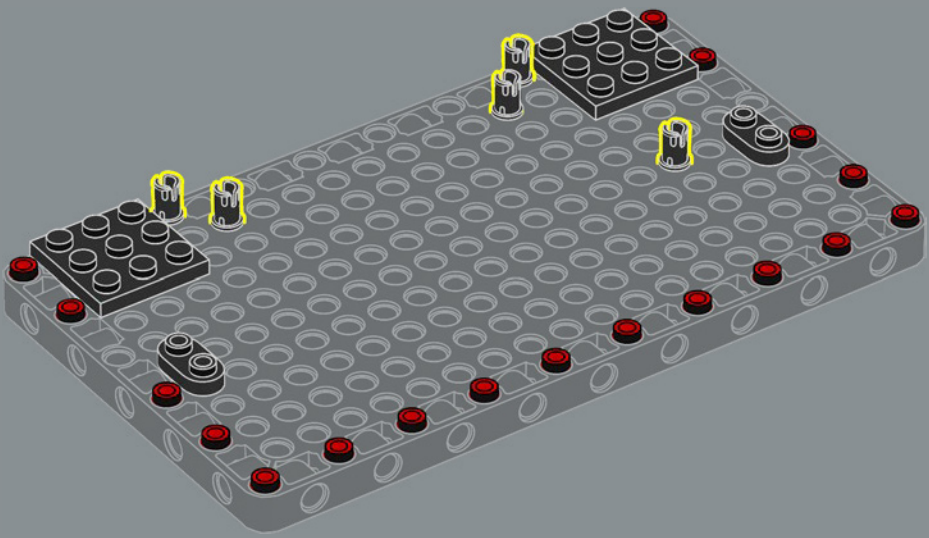



113

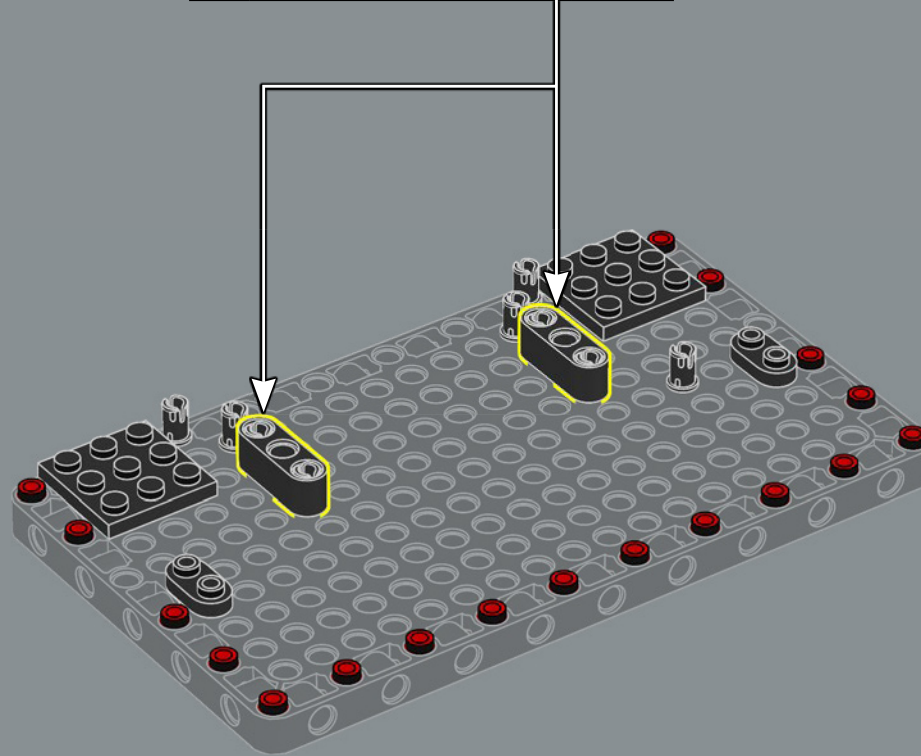
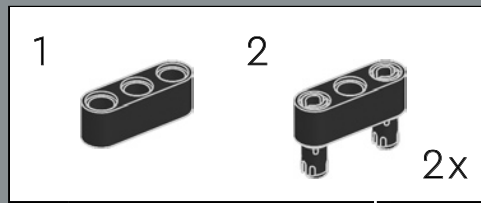

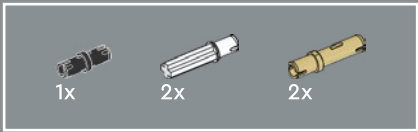

114

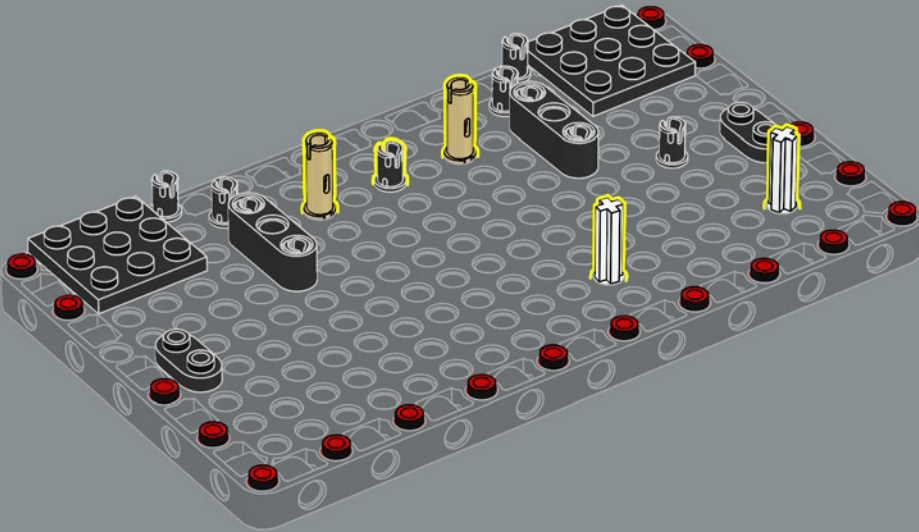
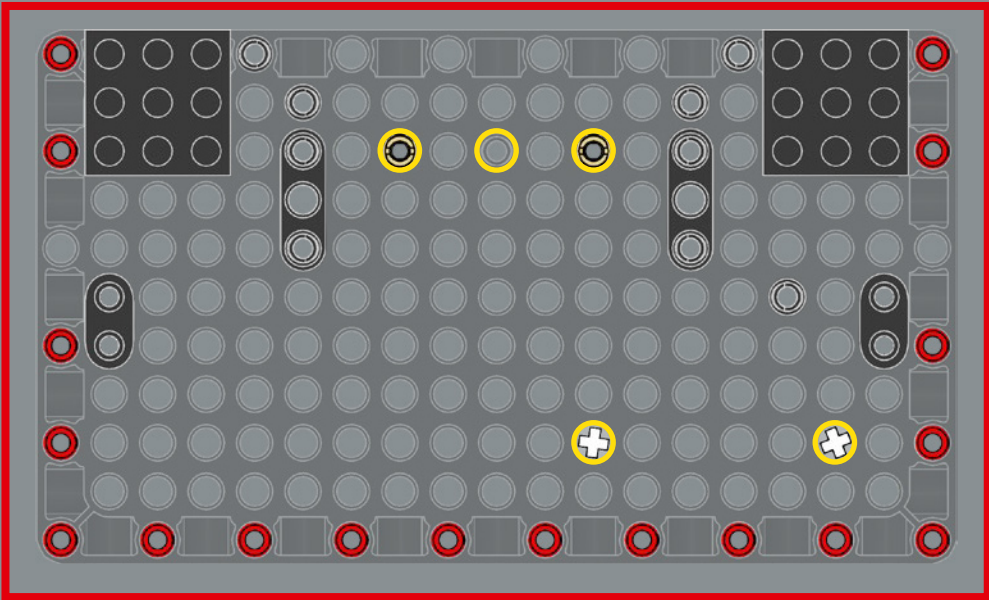



115

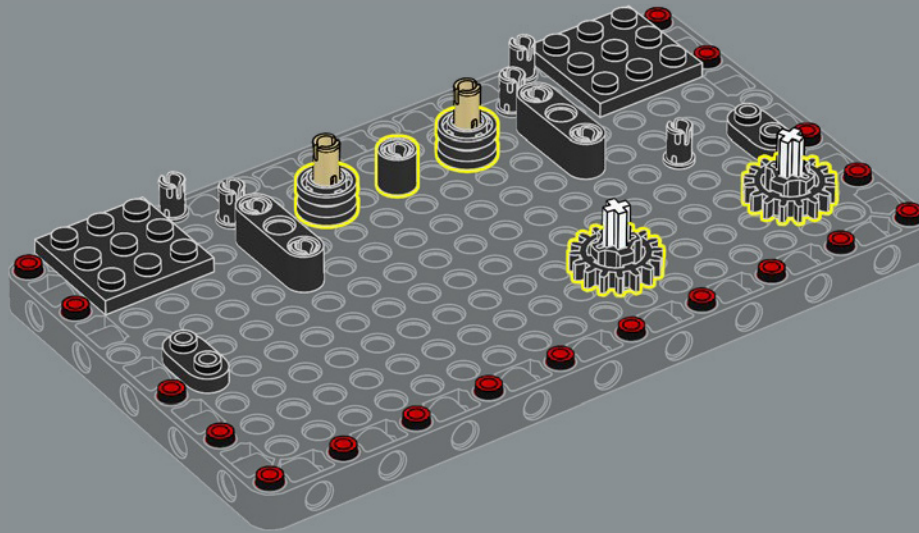

116

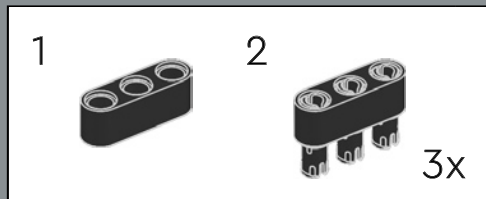
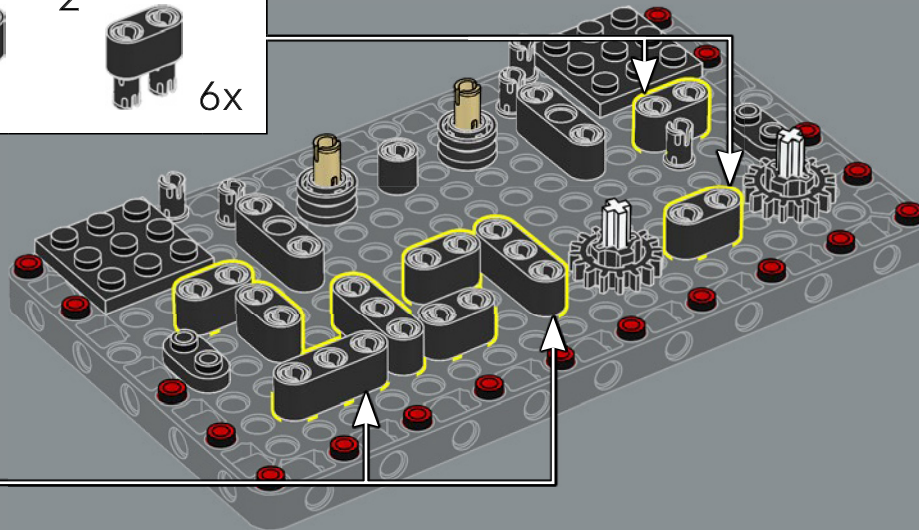
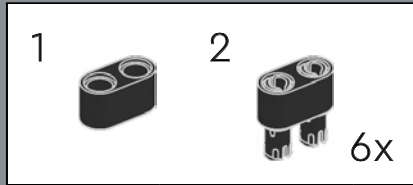



117

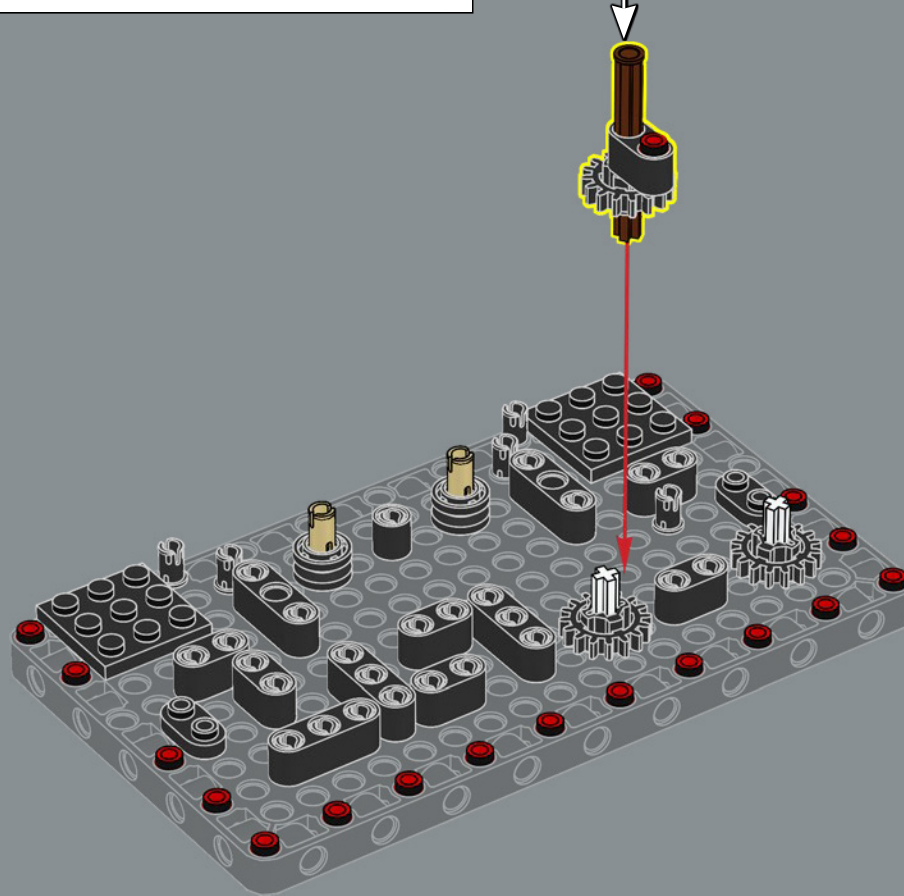
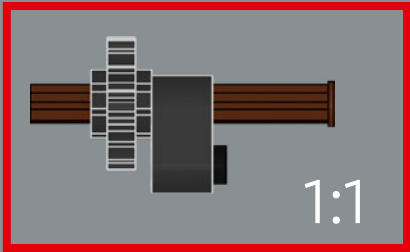
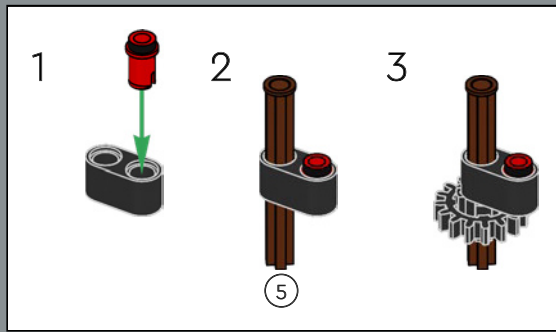

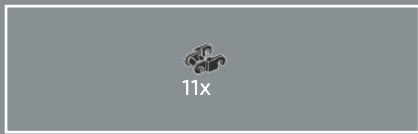

118

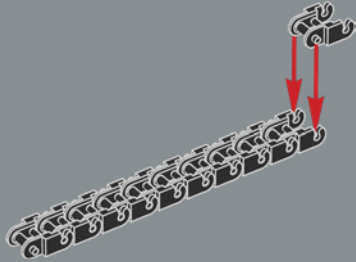

119

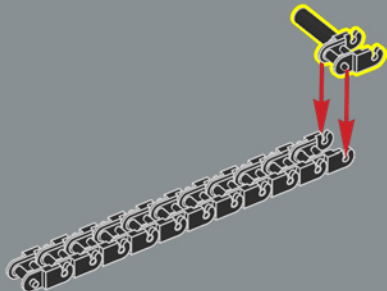

120

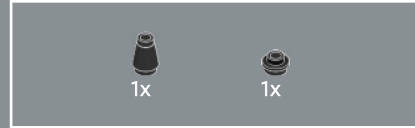
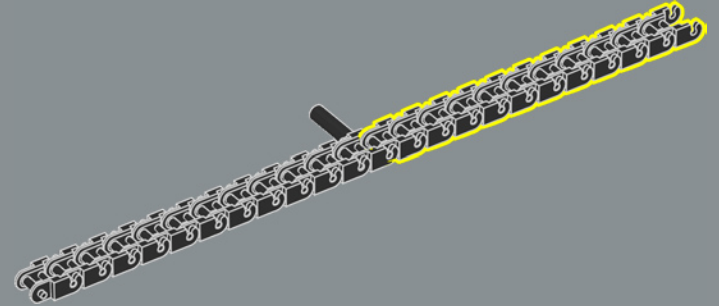

121

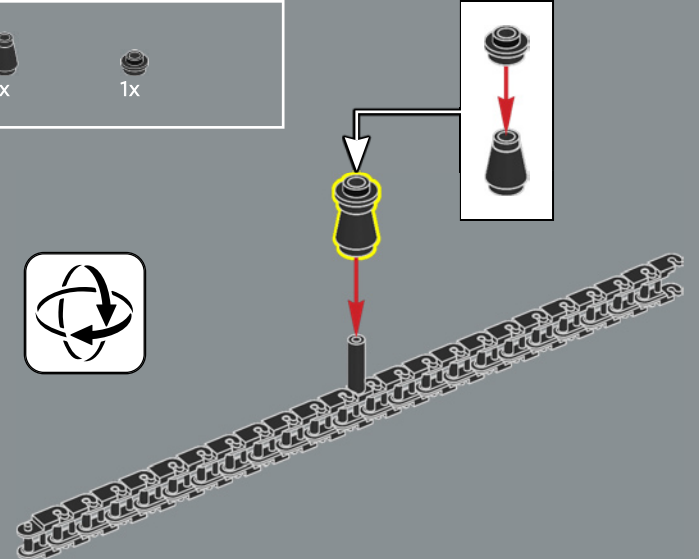



1x



122

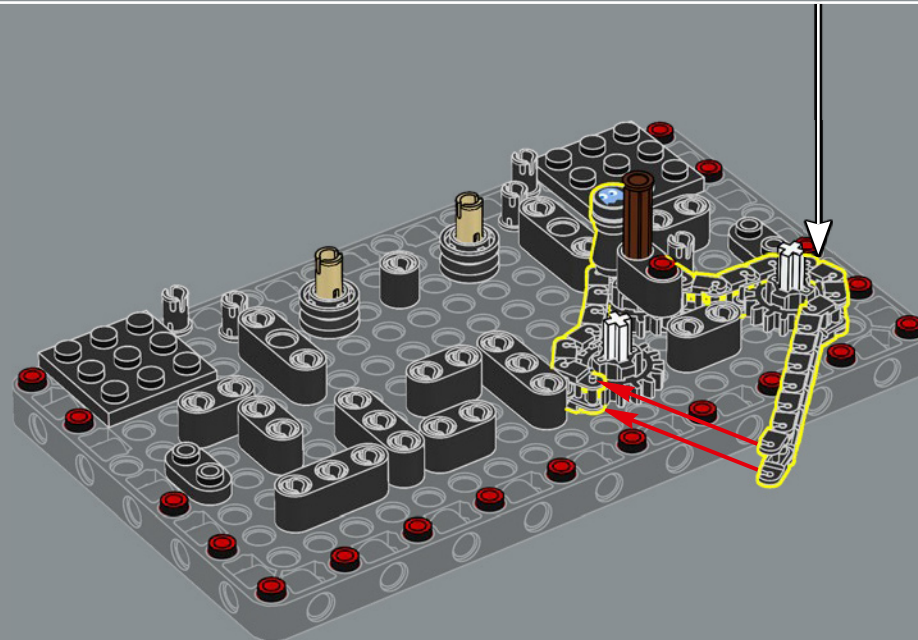
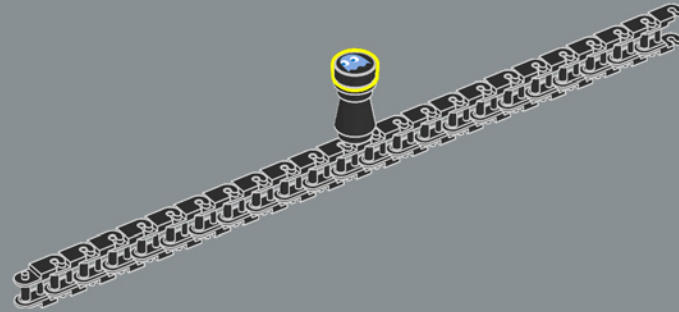



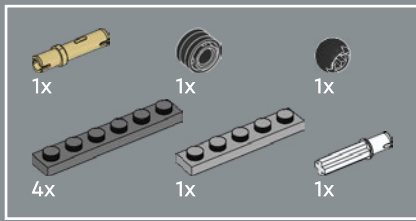

123

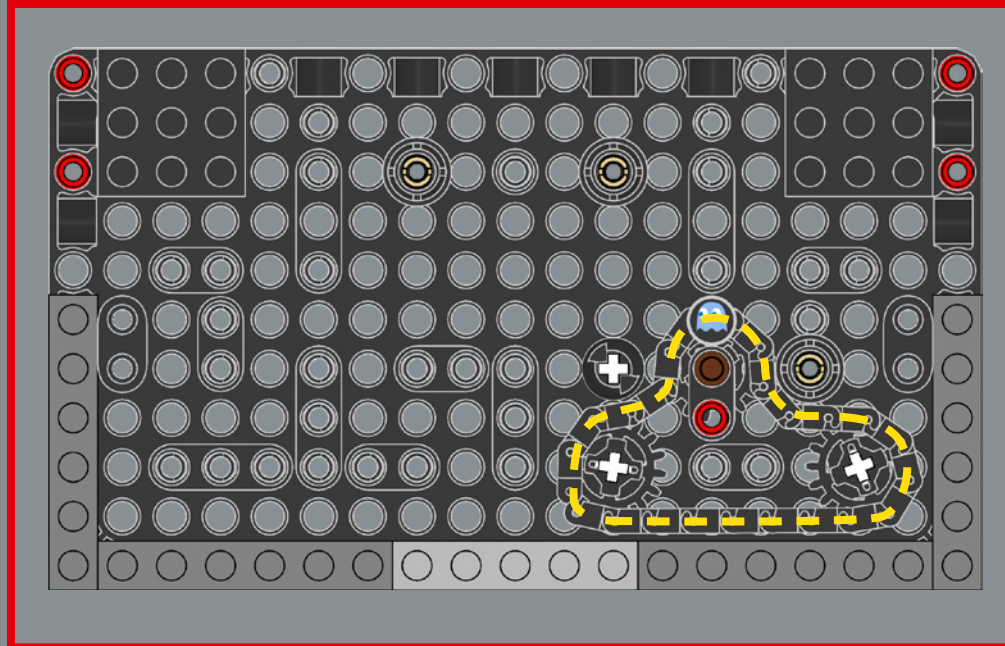
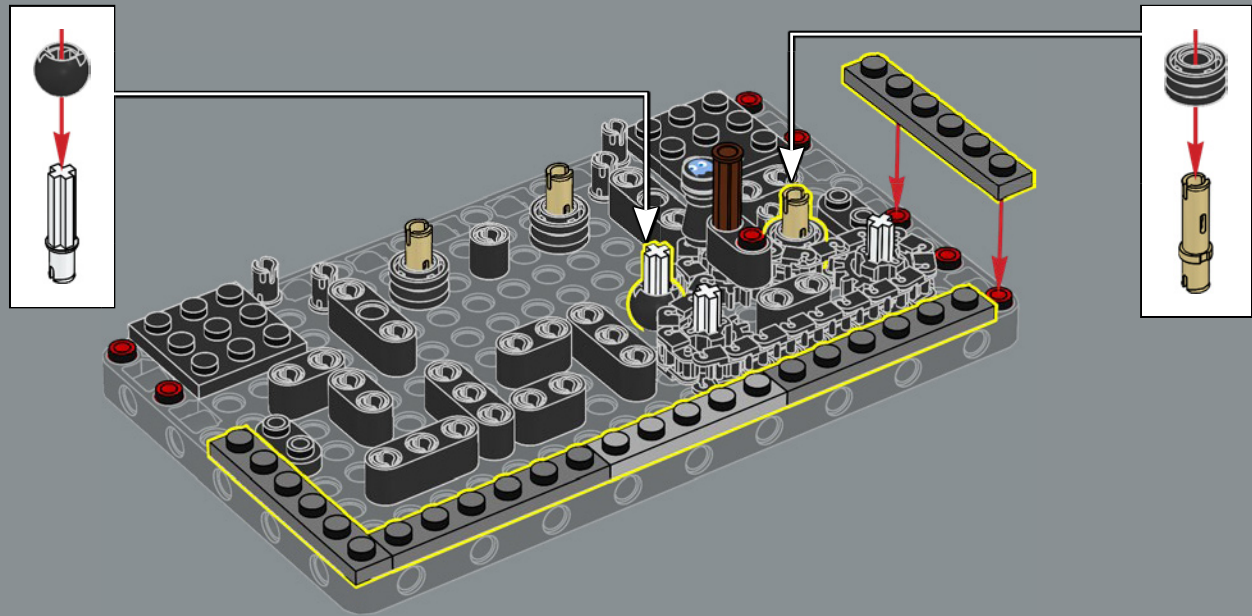

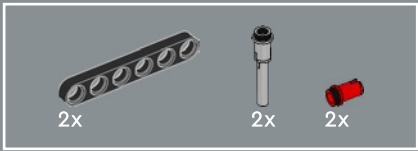

124

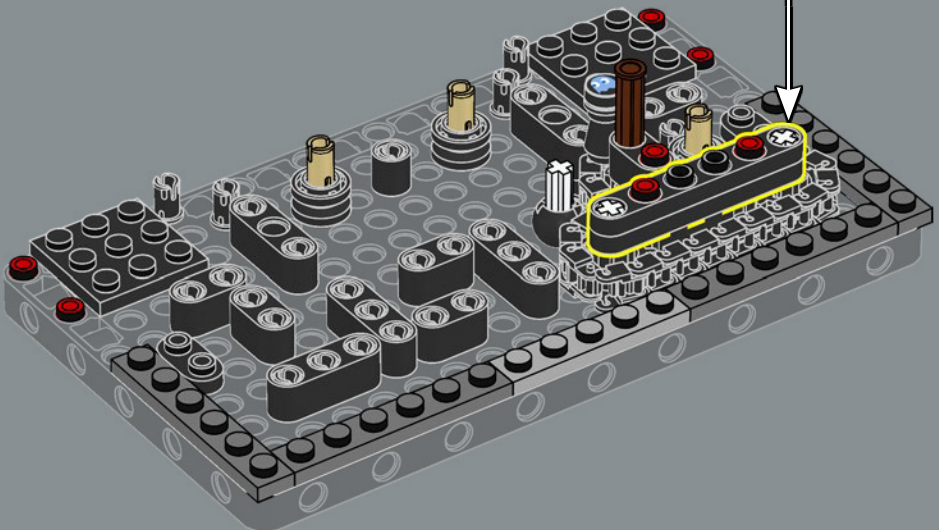
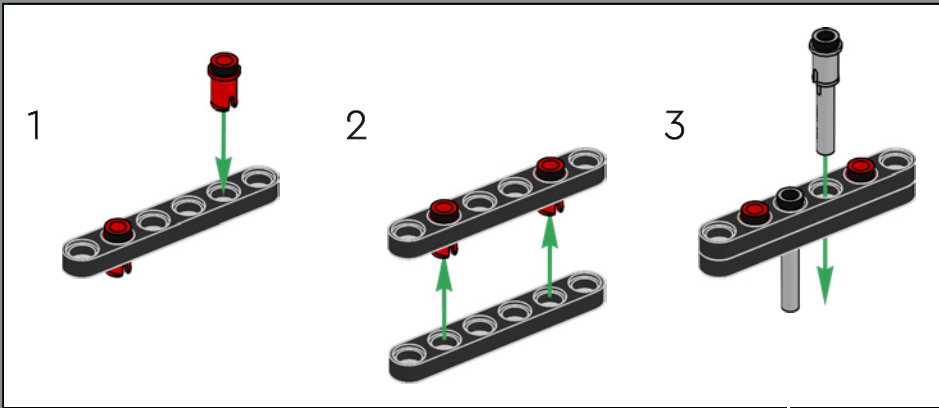

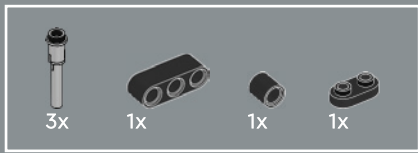

125

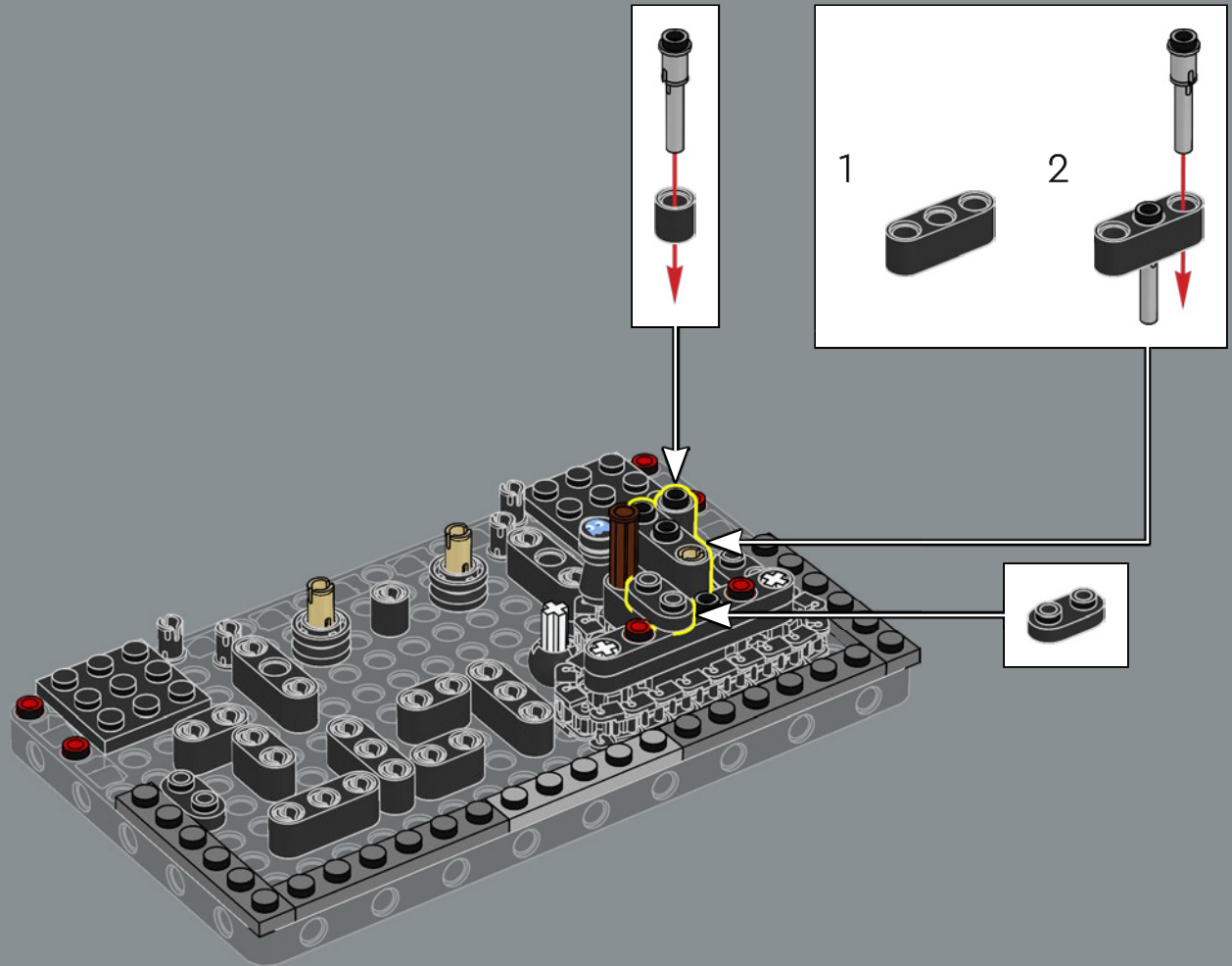

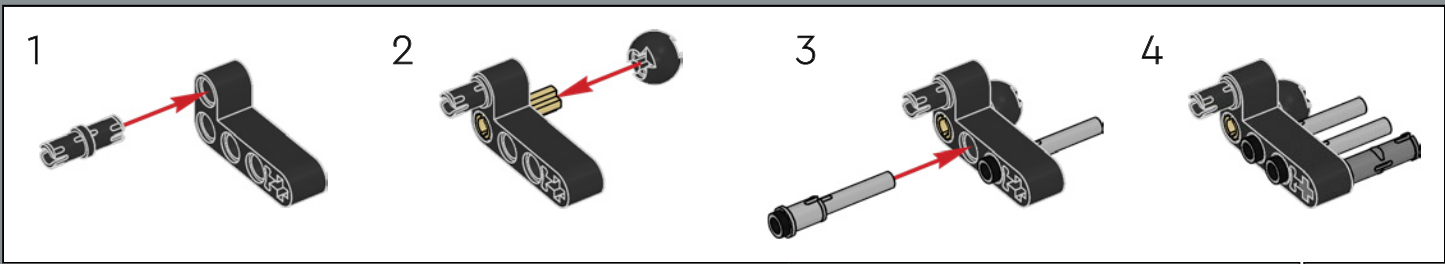
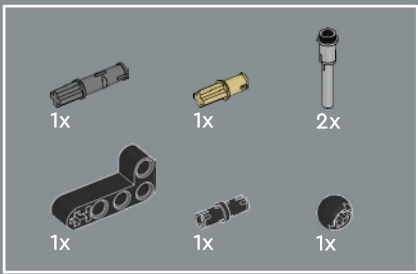

126

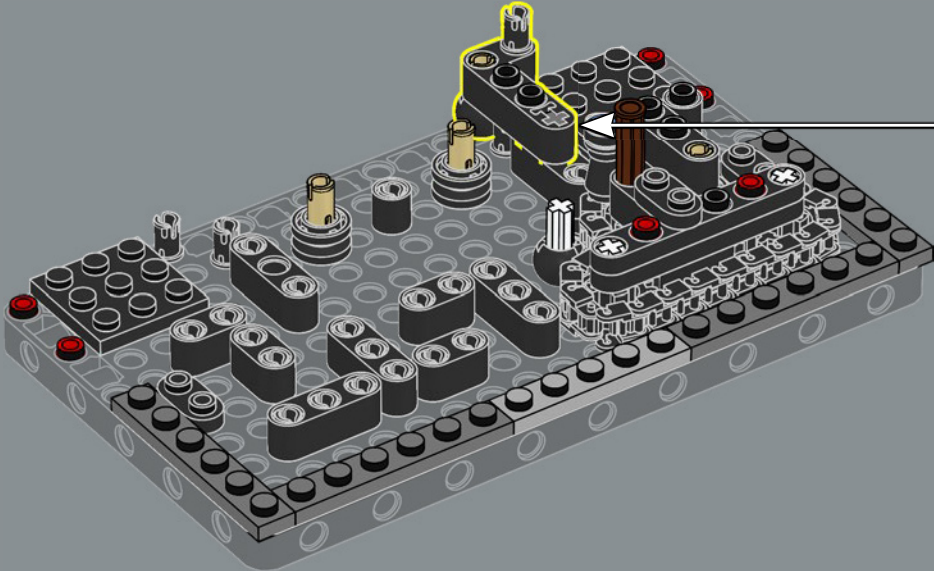

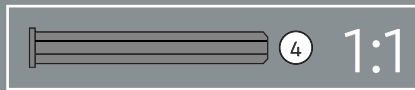
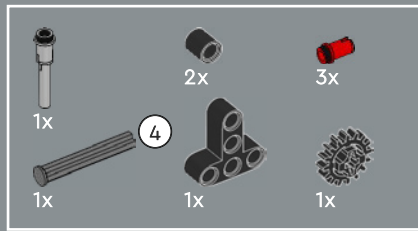

127

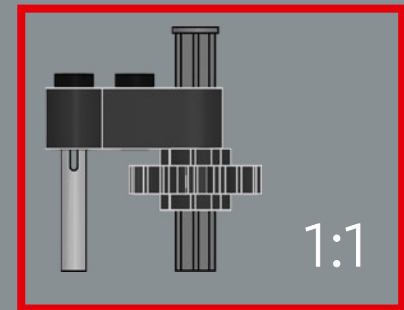
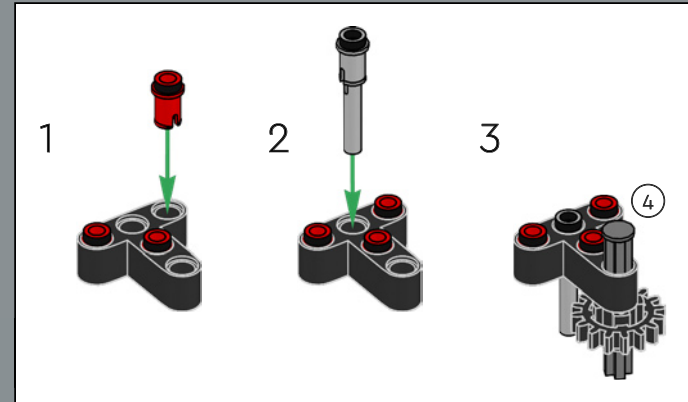
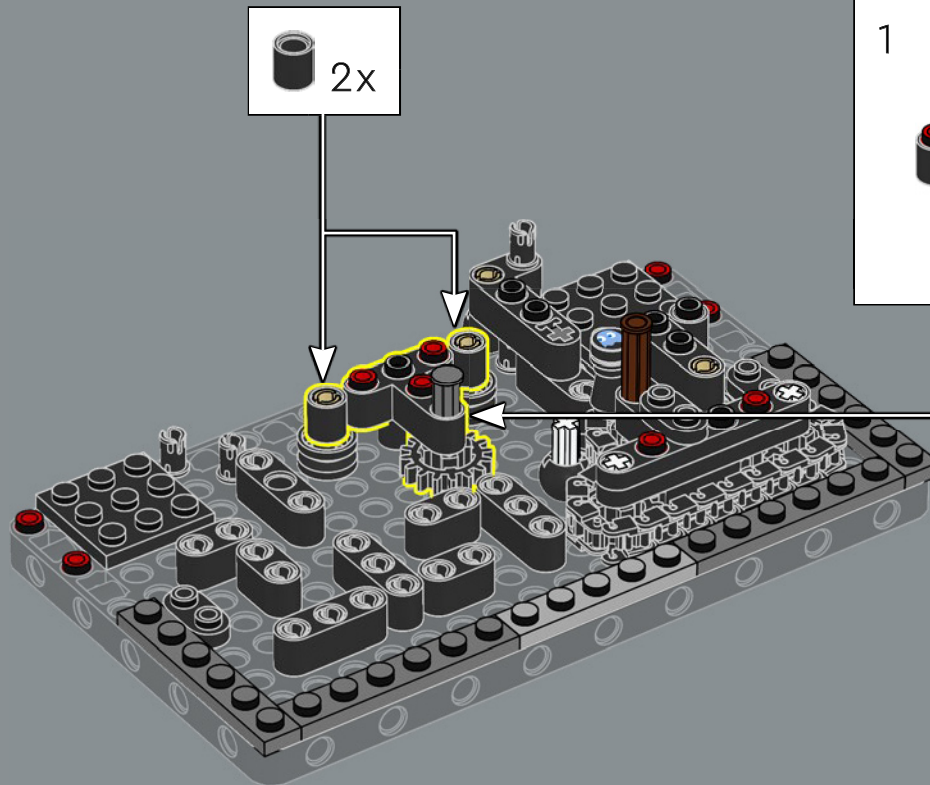

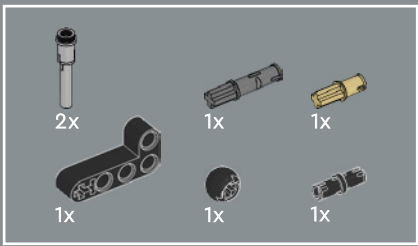

128

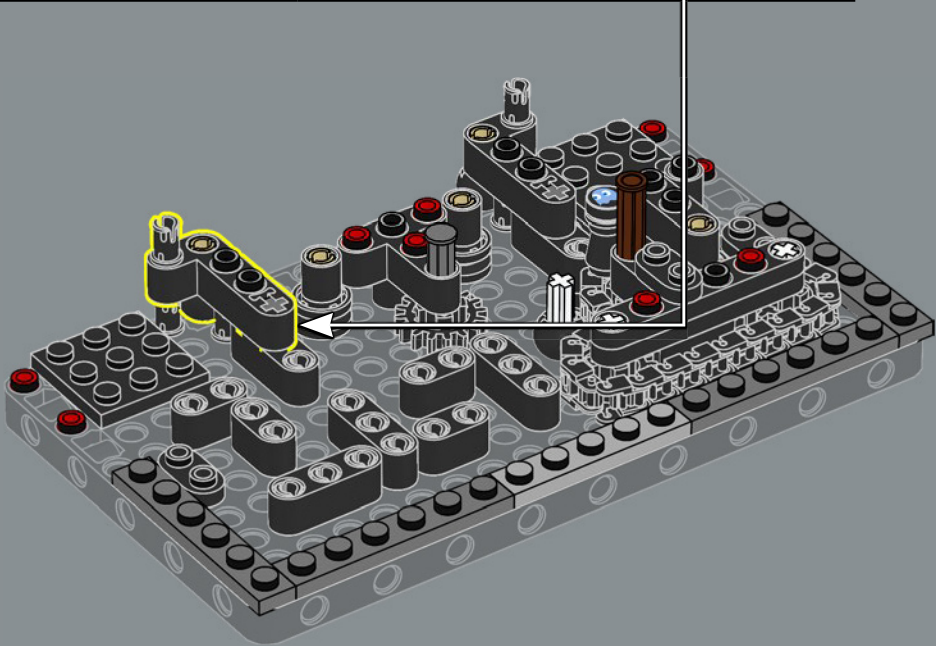
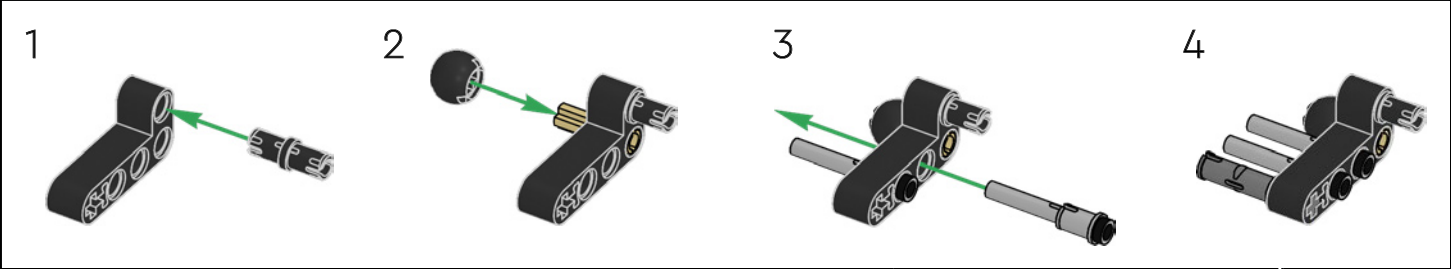

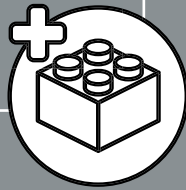
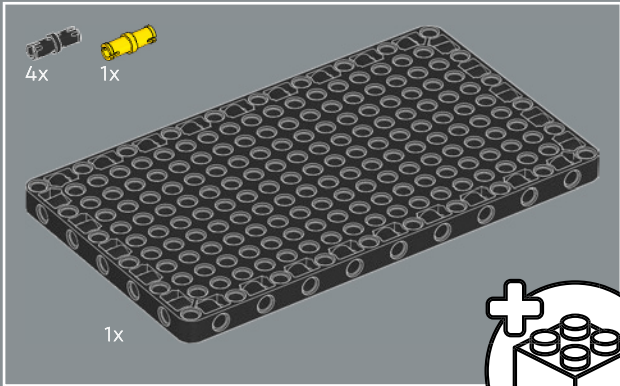
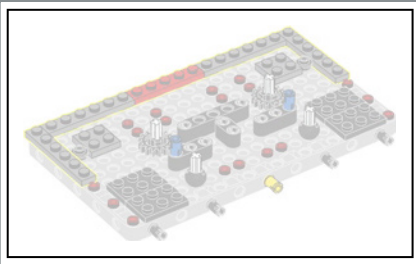

129

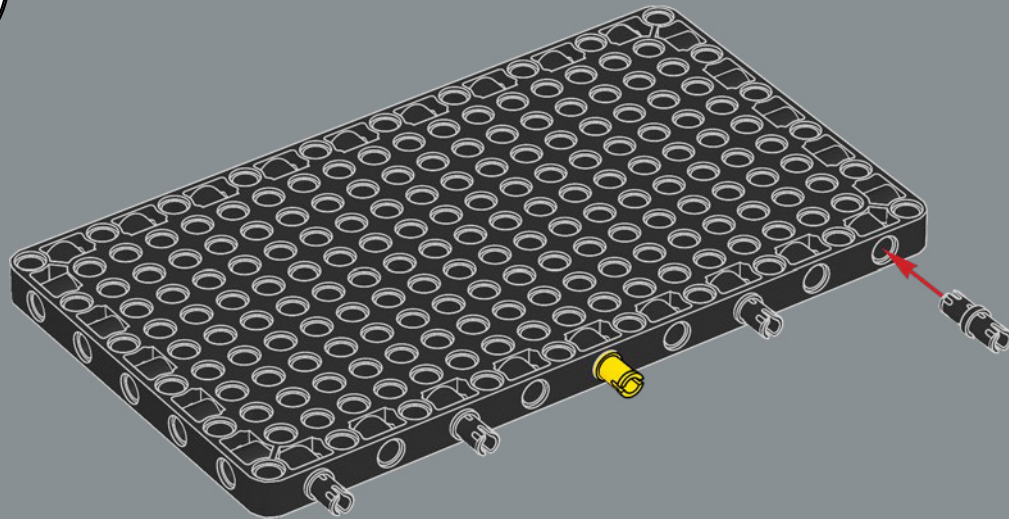



20x

130

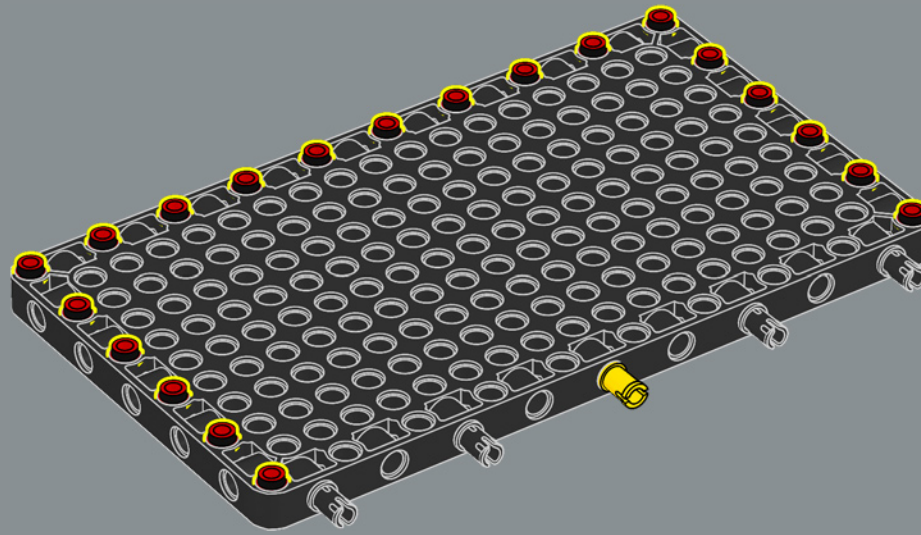

34x

131

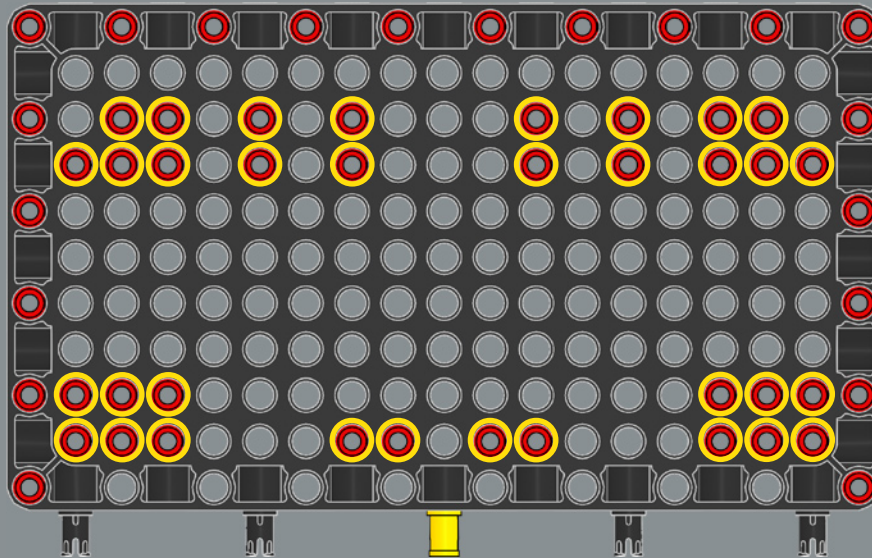



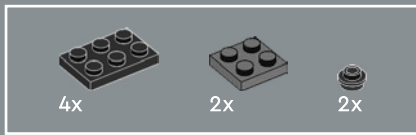

132

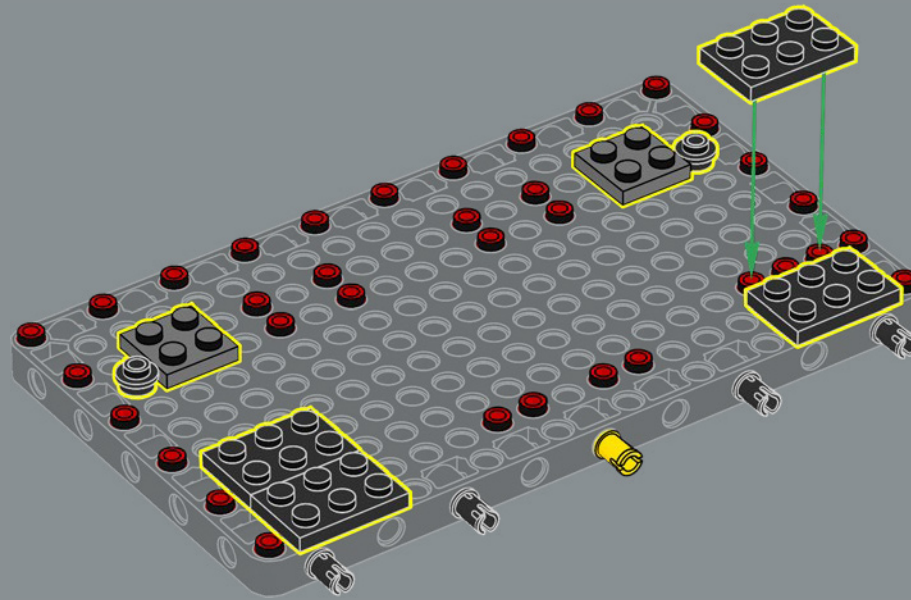

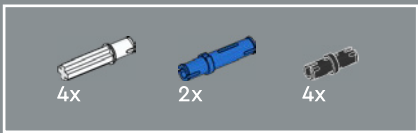

133

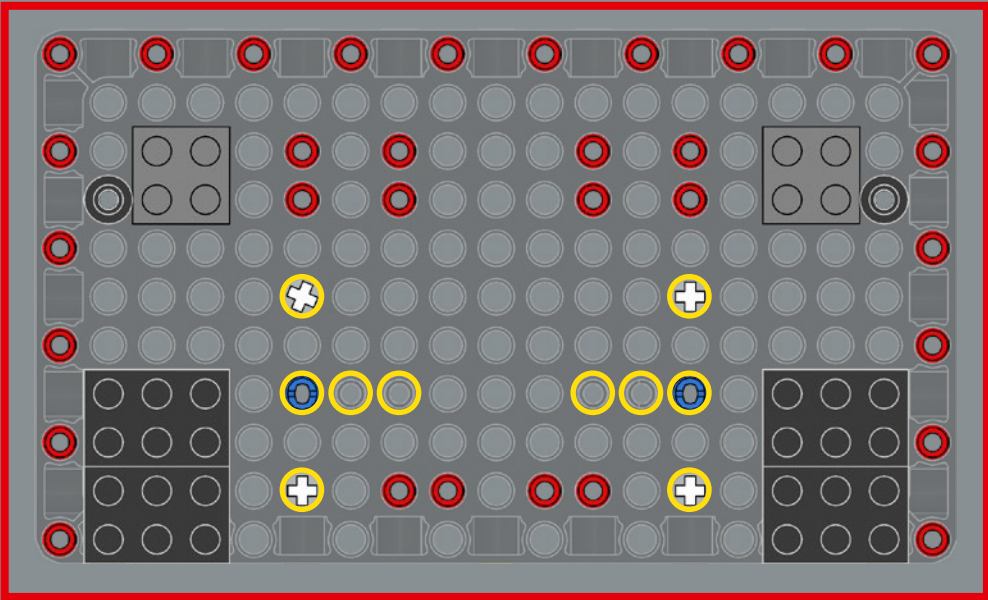
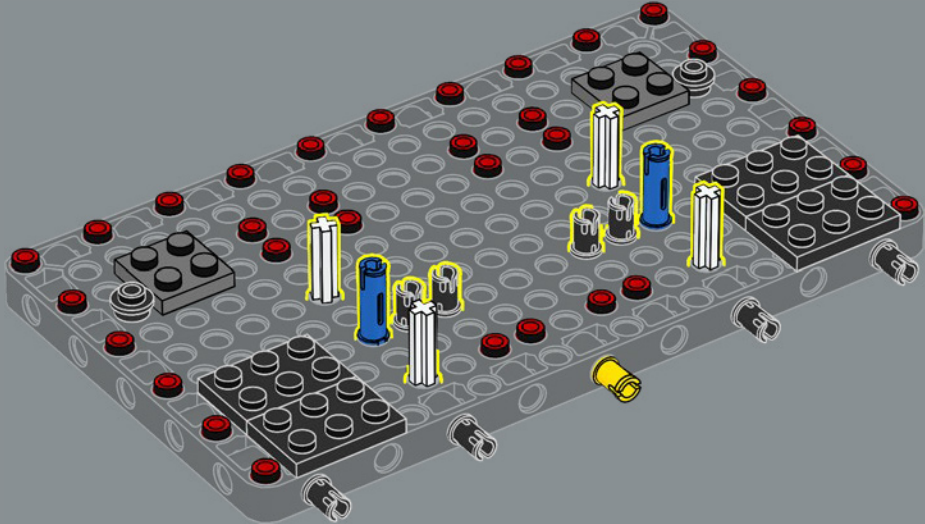

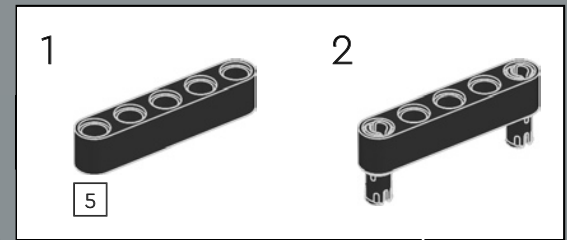
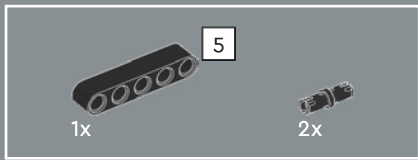

134

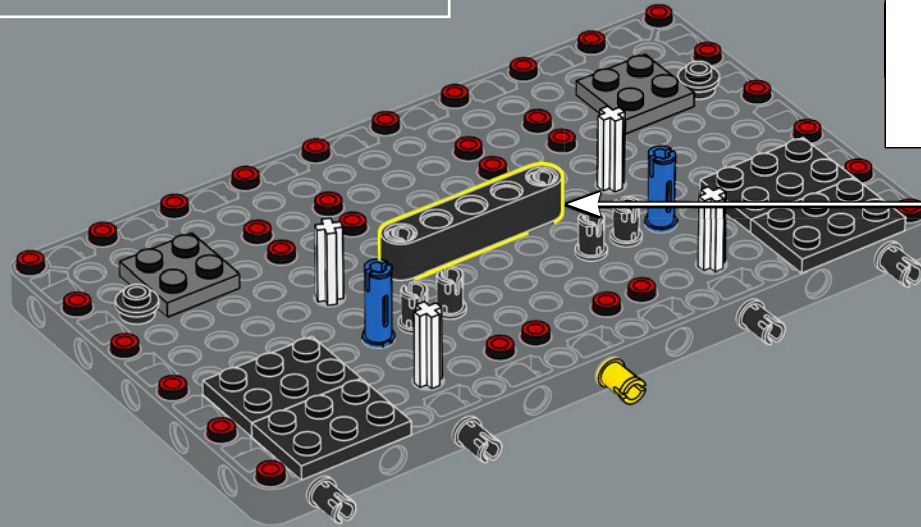

135

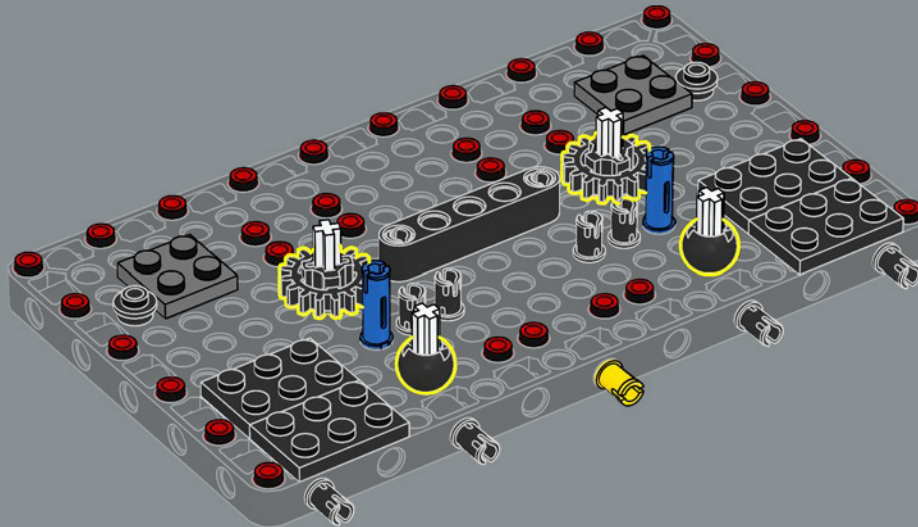



136

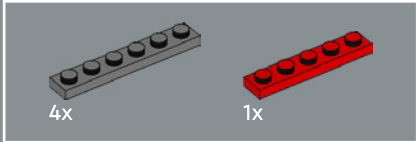
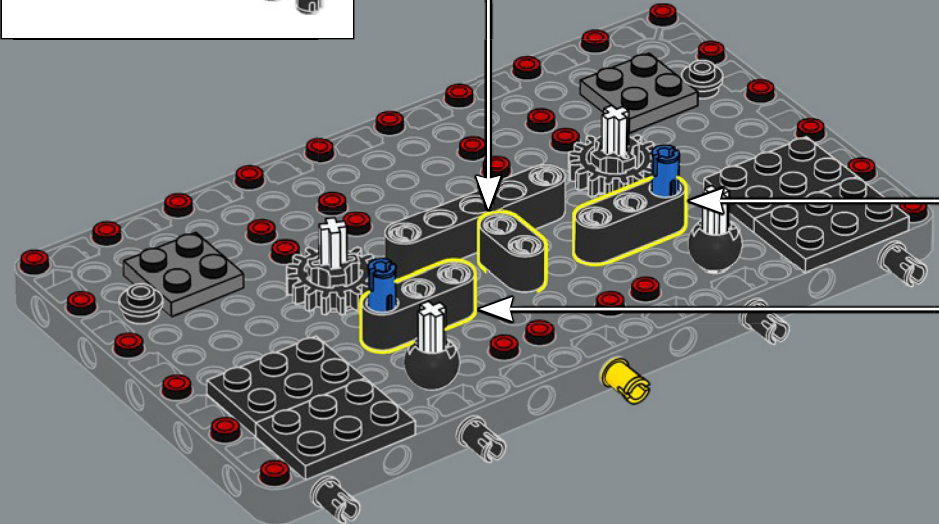
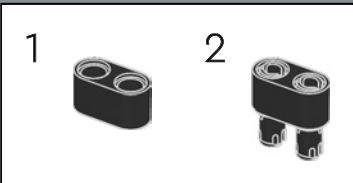

137

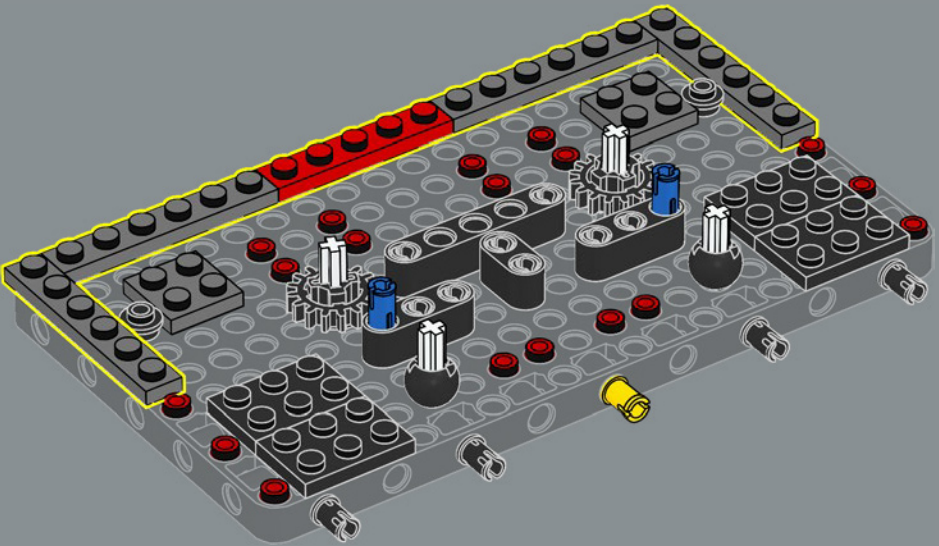

138

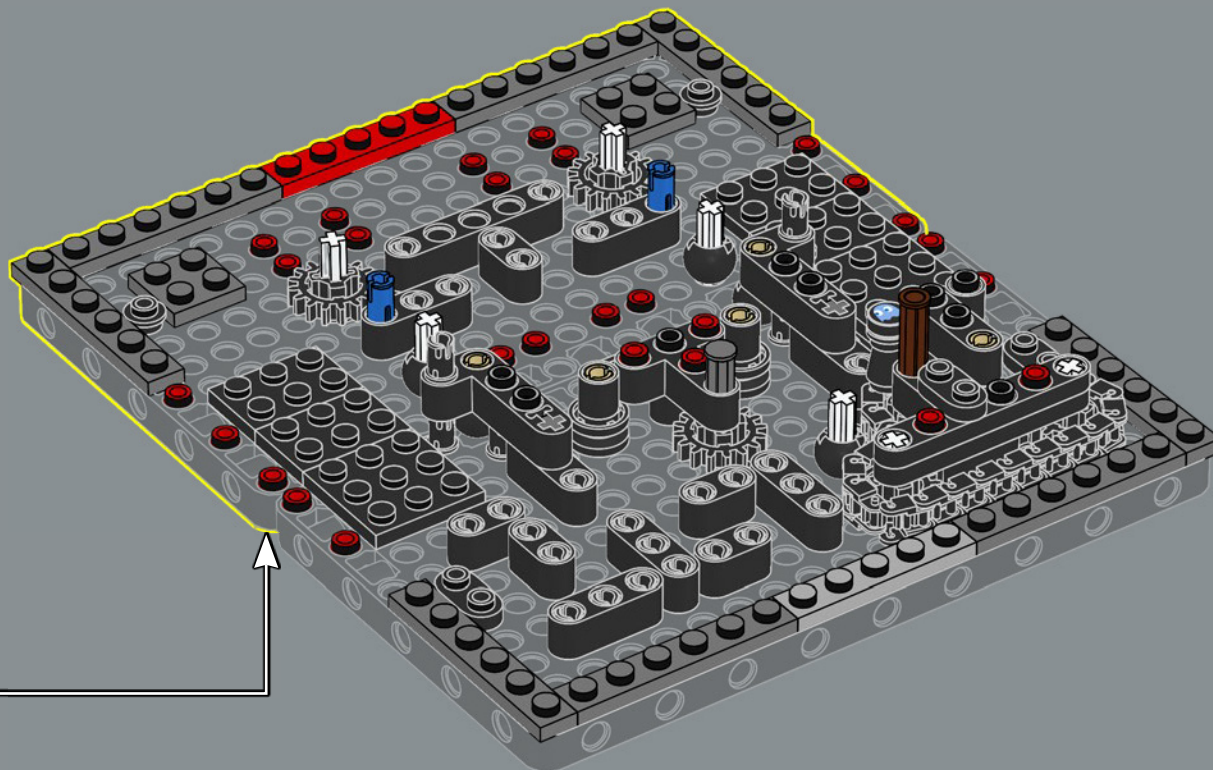

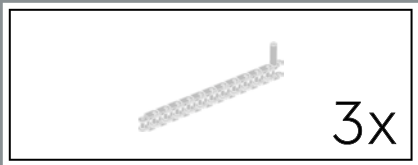

139

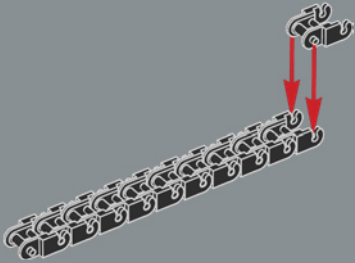

140

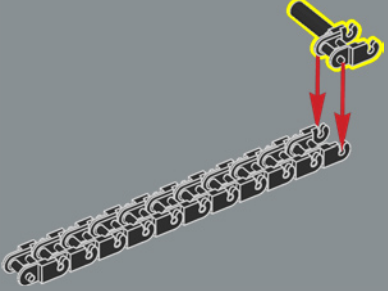

3x



1:1

141

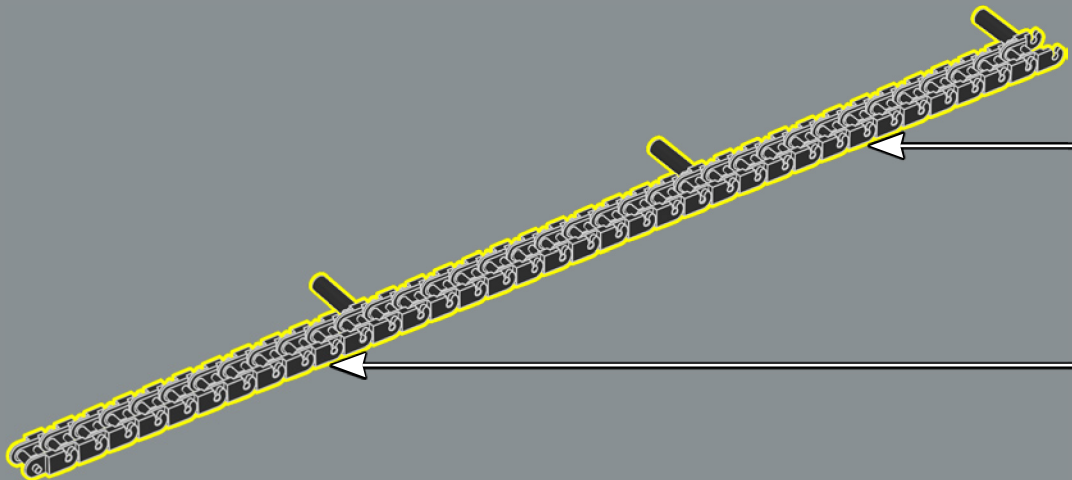



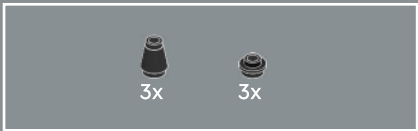
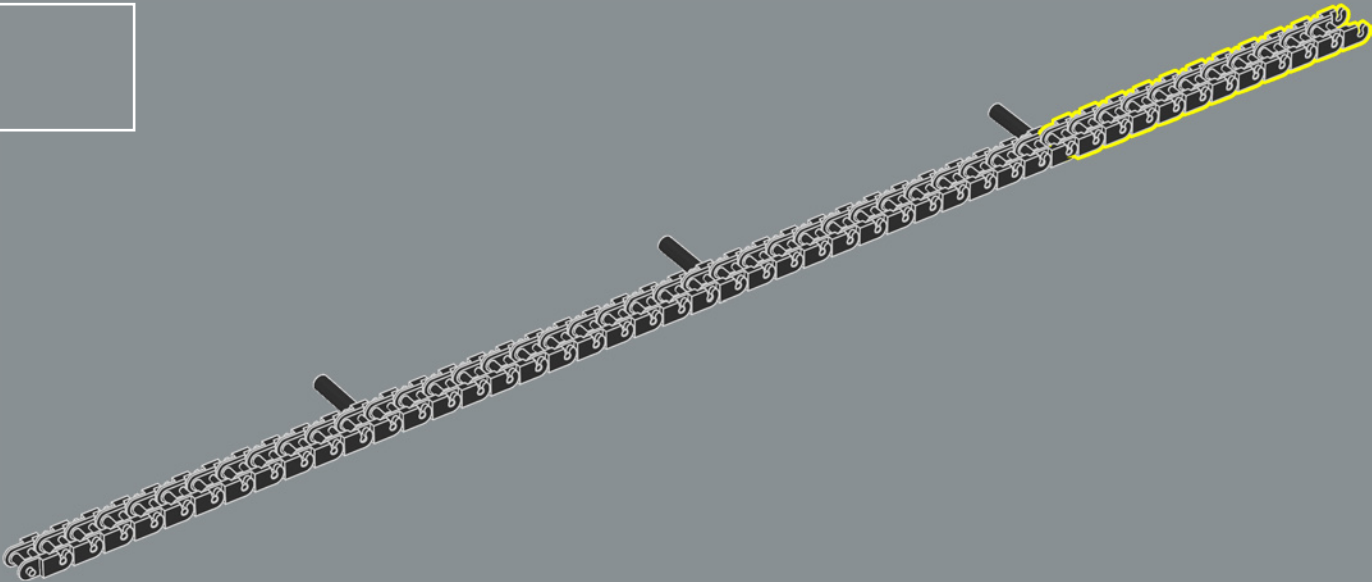

142

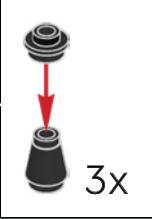
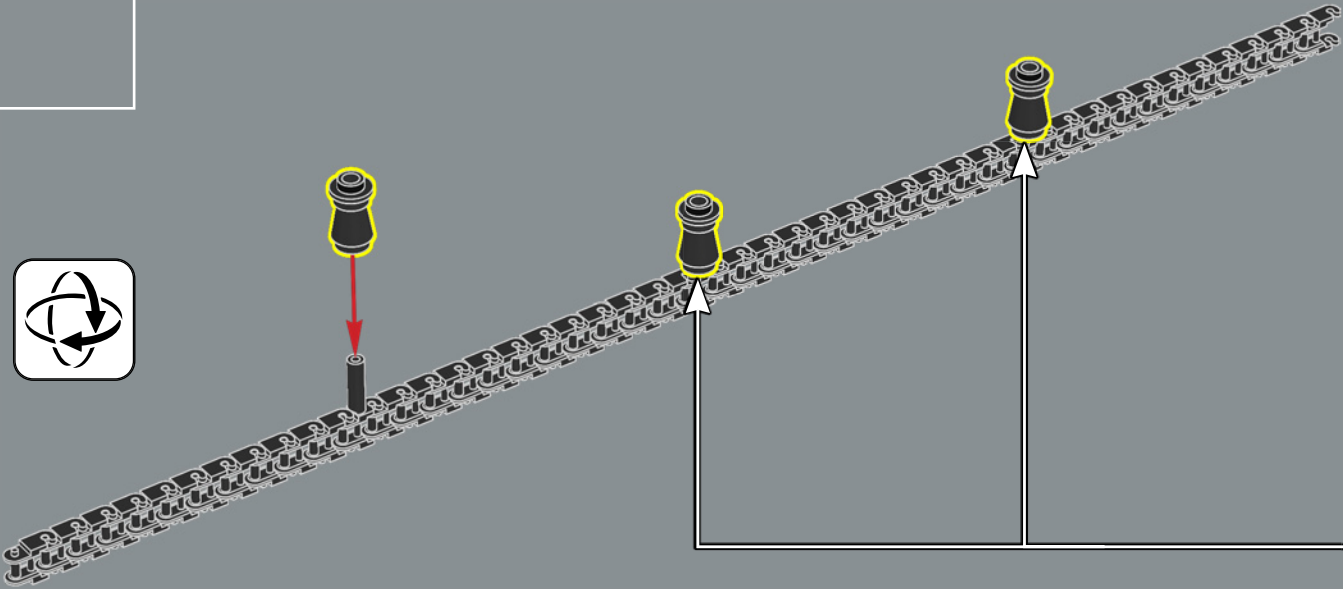

143



- 1x 
- 1x 
- 1x 

144

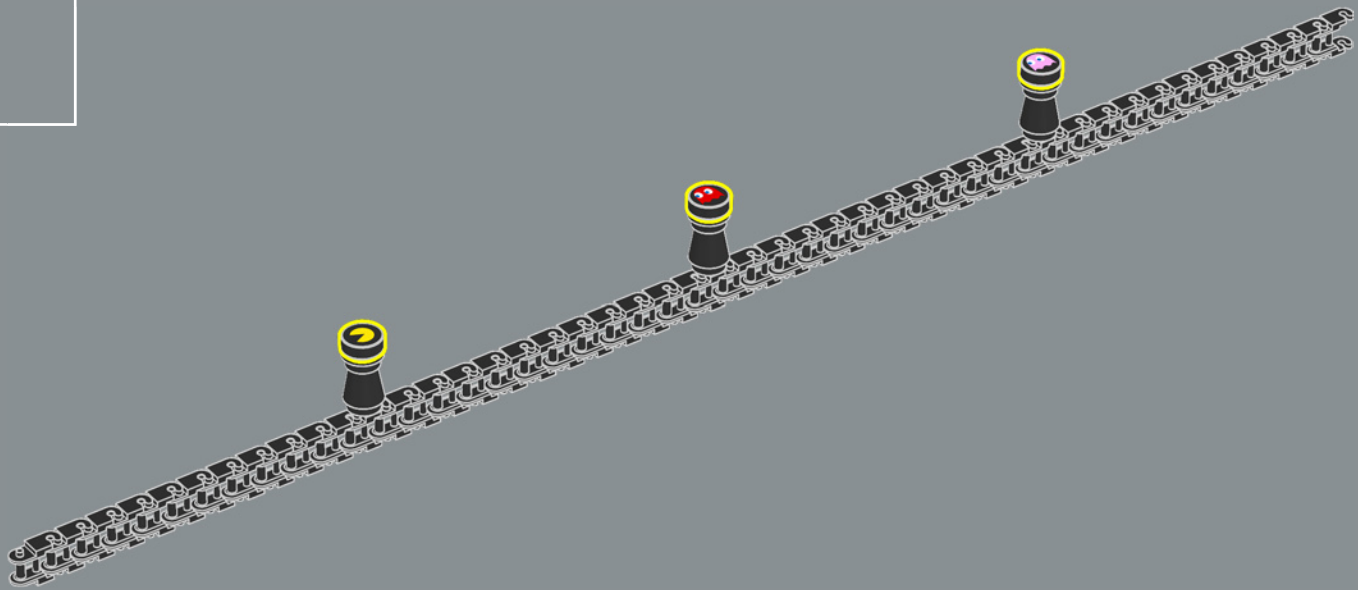

145

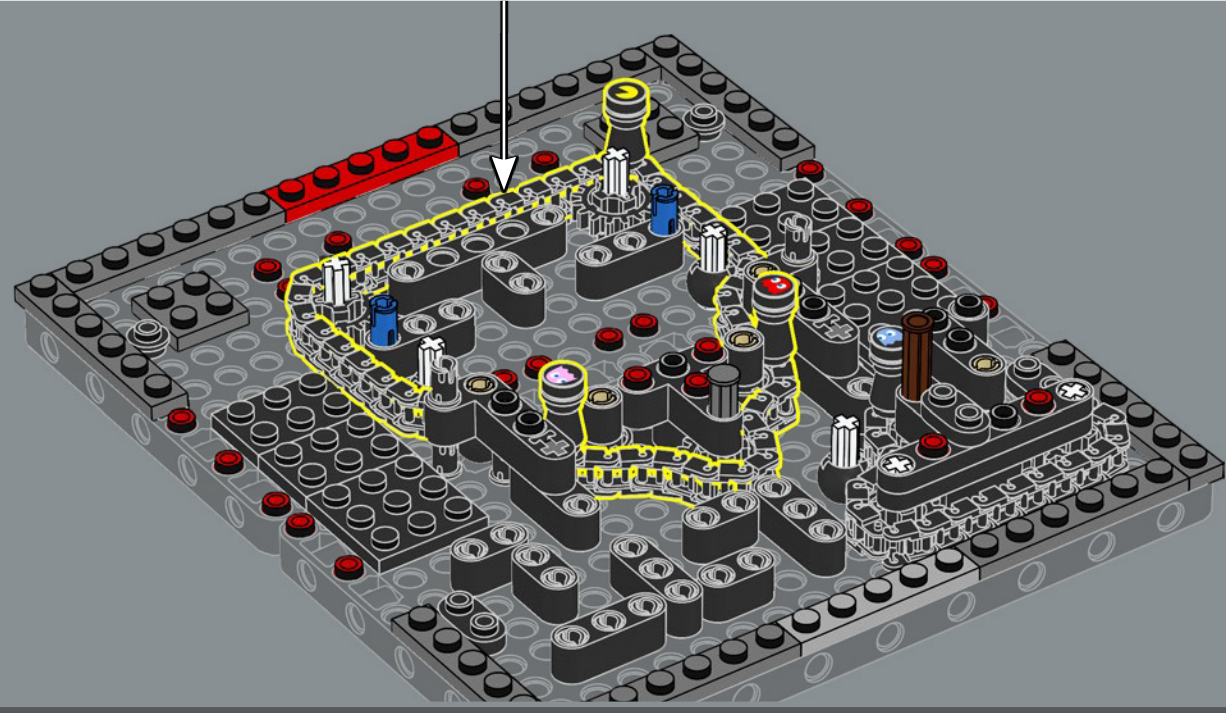



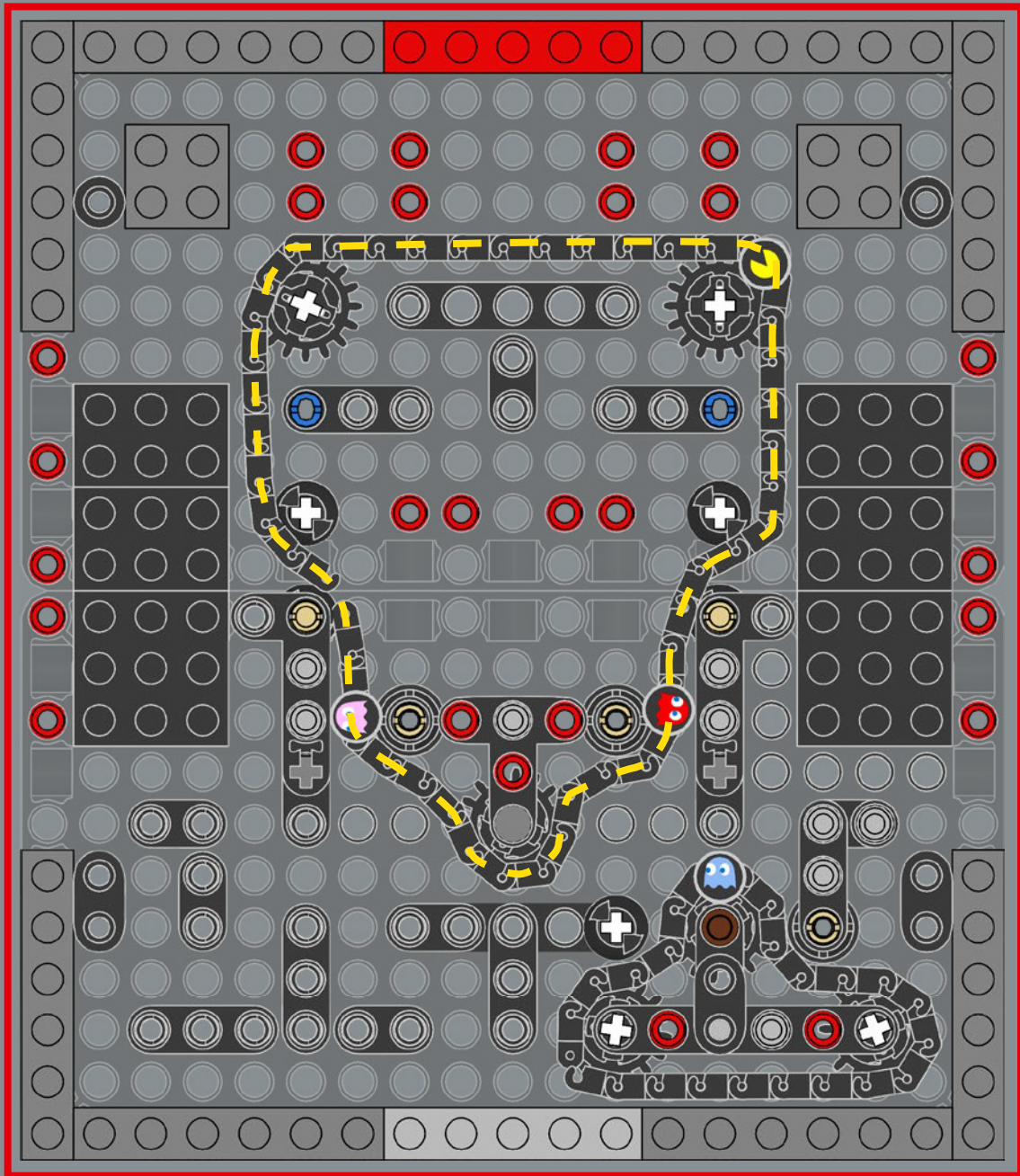

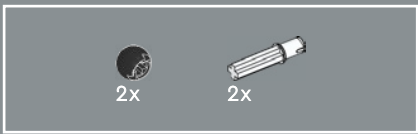

146

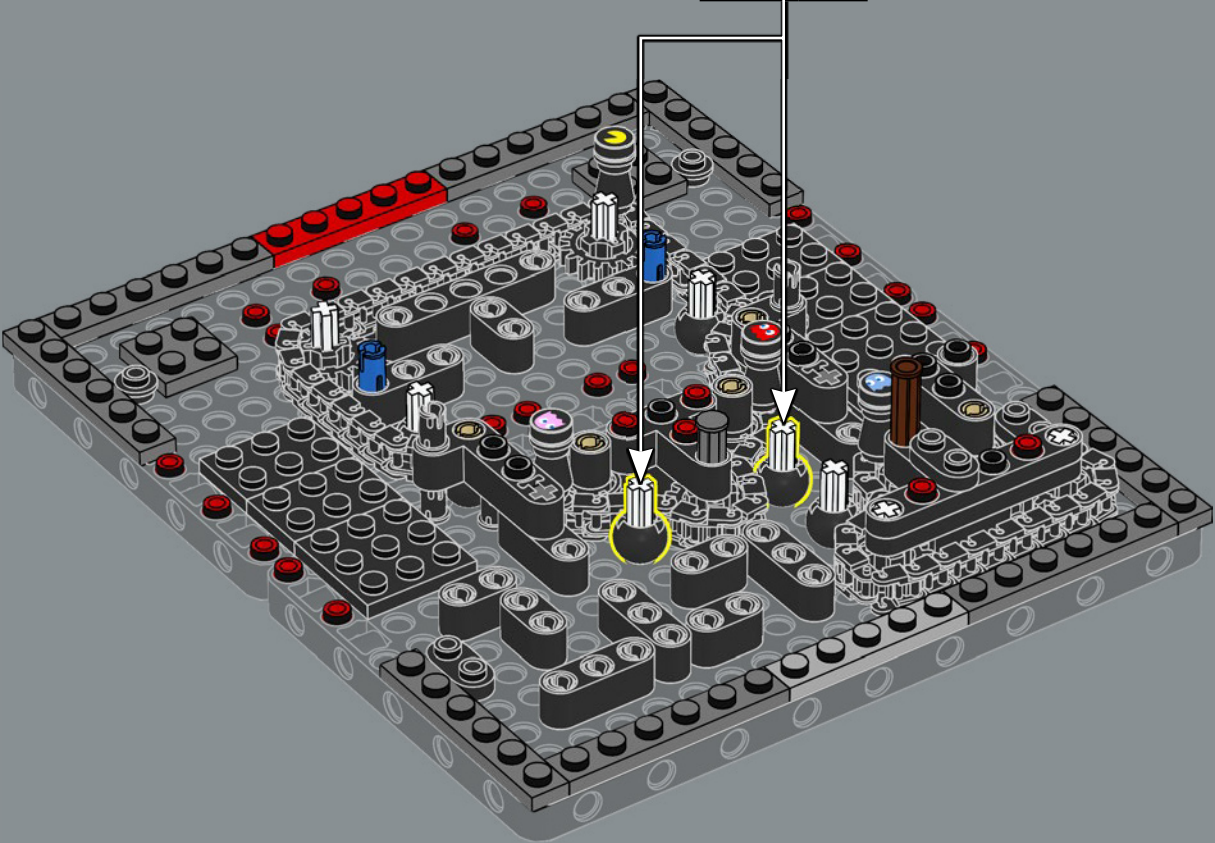
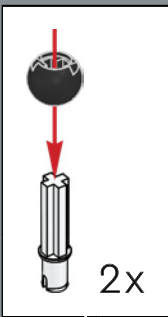



147

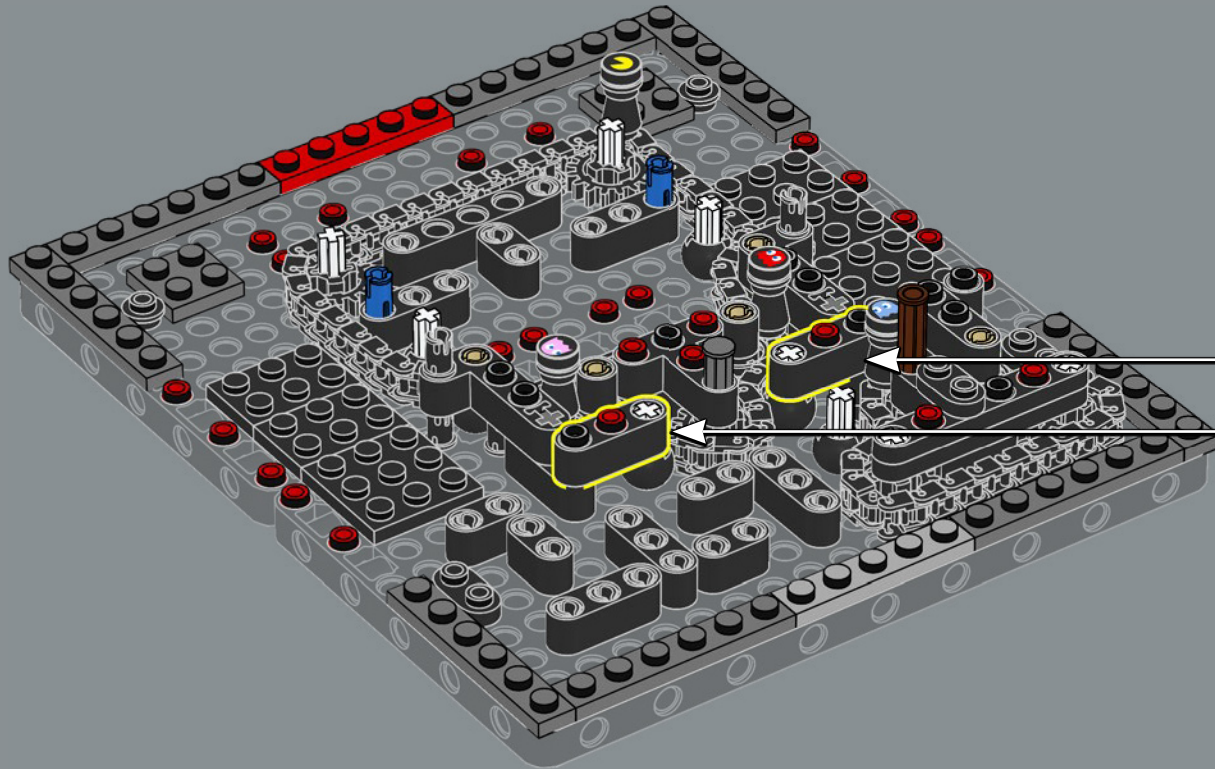
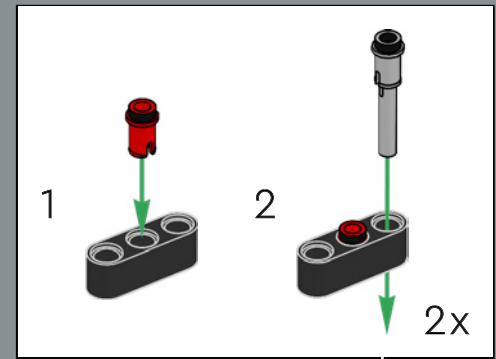

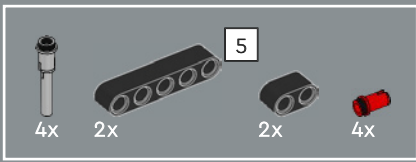

148

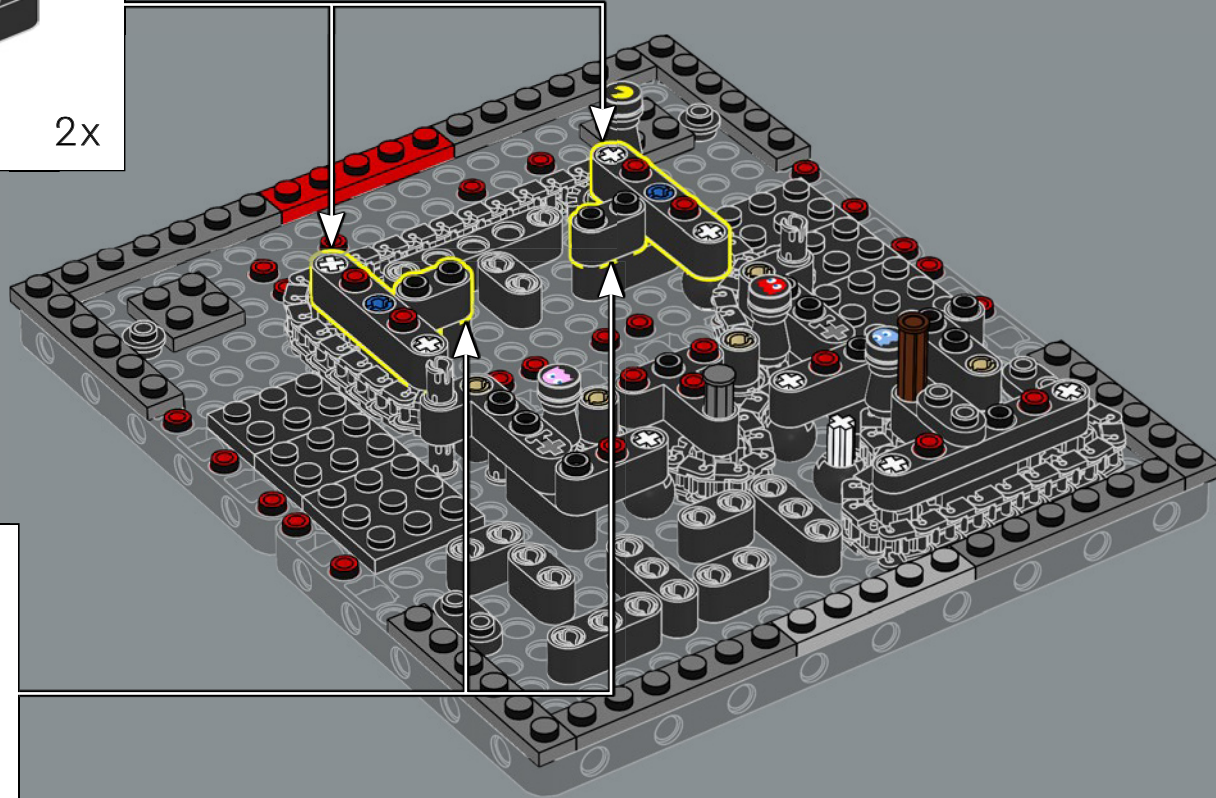
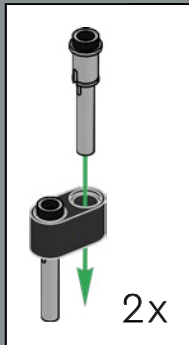
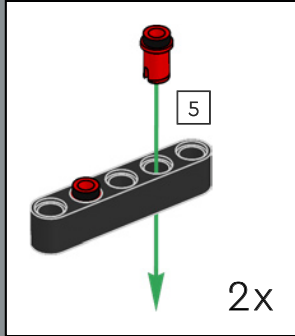

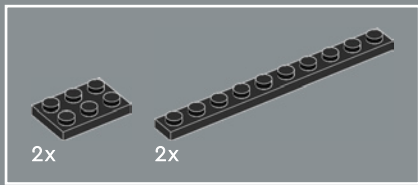

149

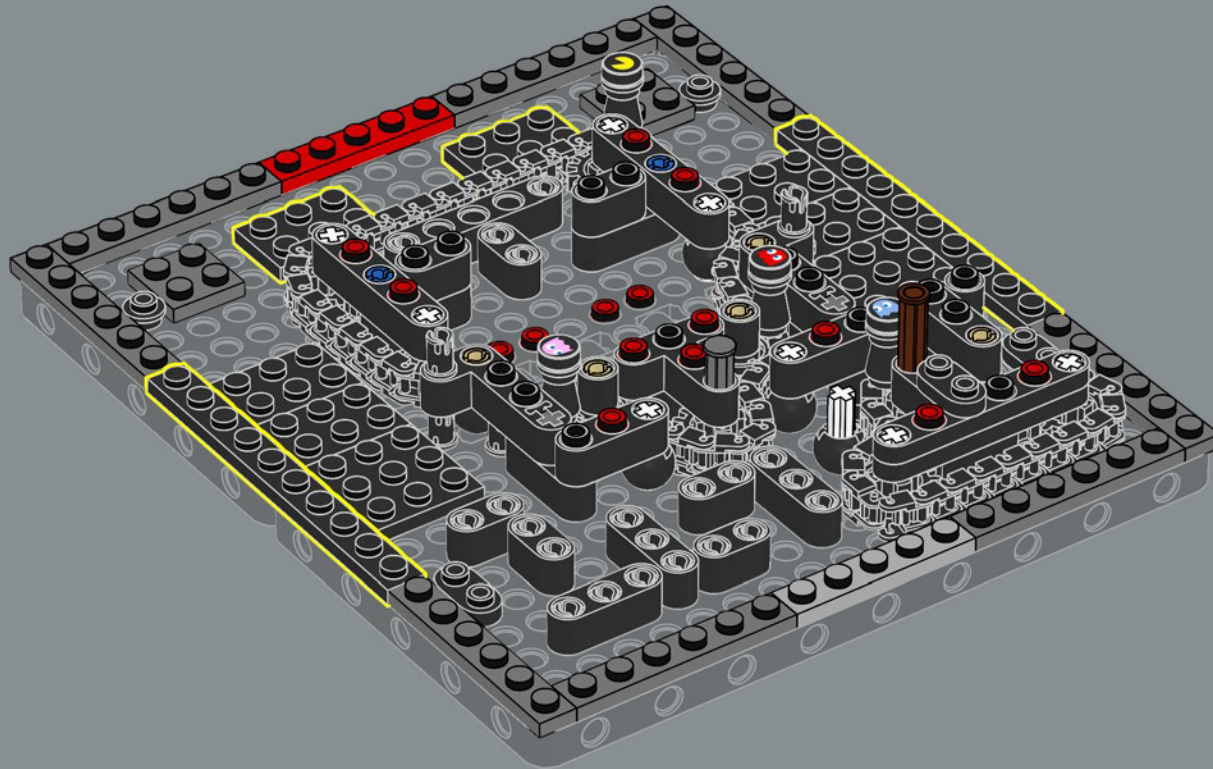

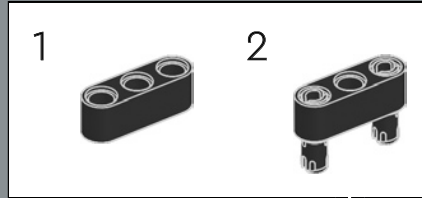

150

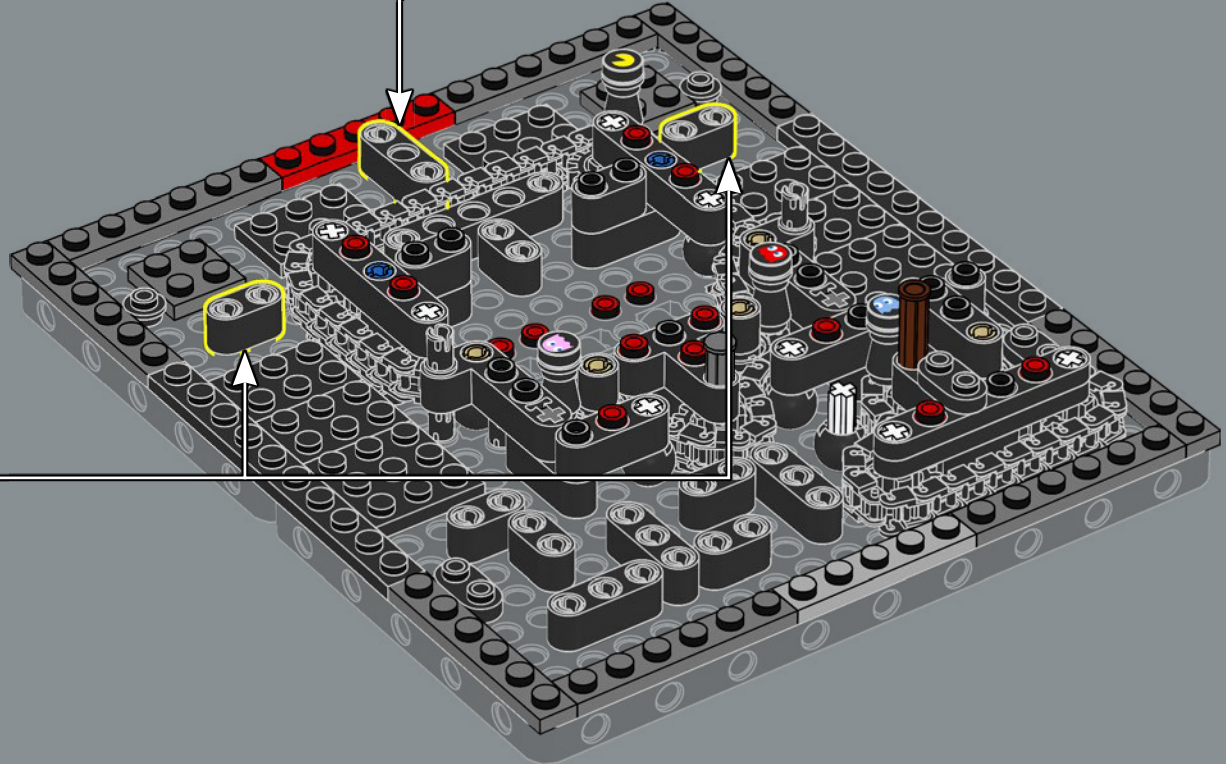
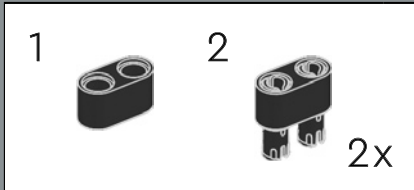

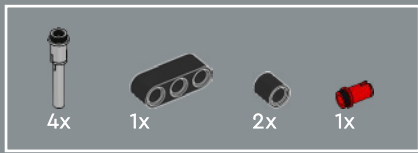

151

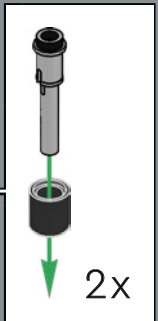
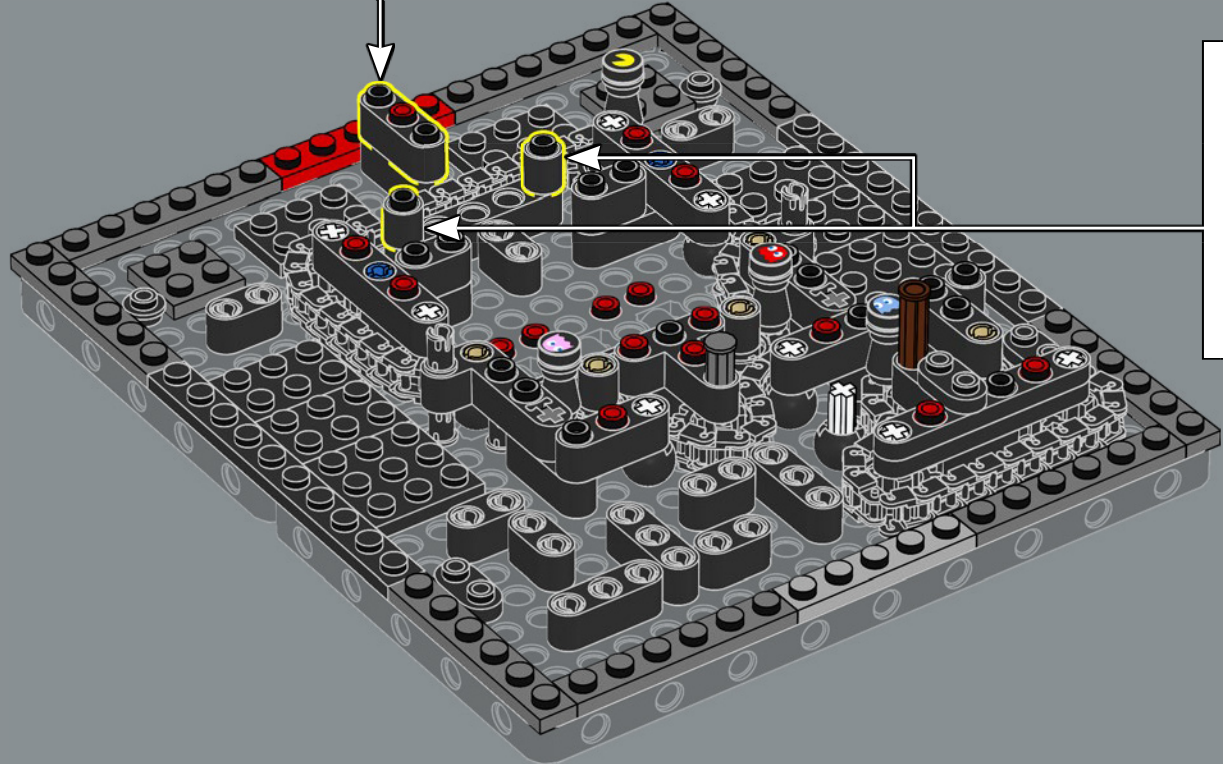
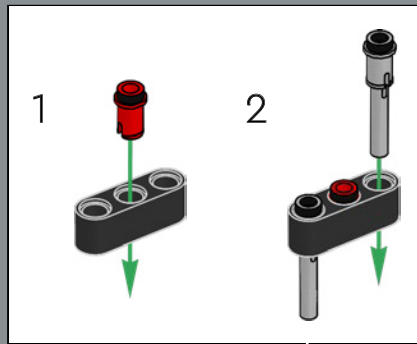

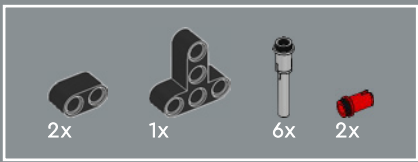

152

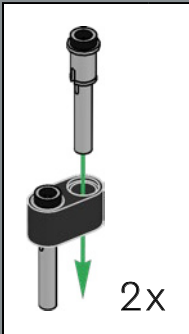
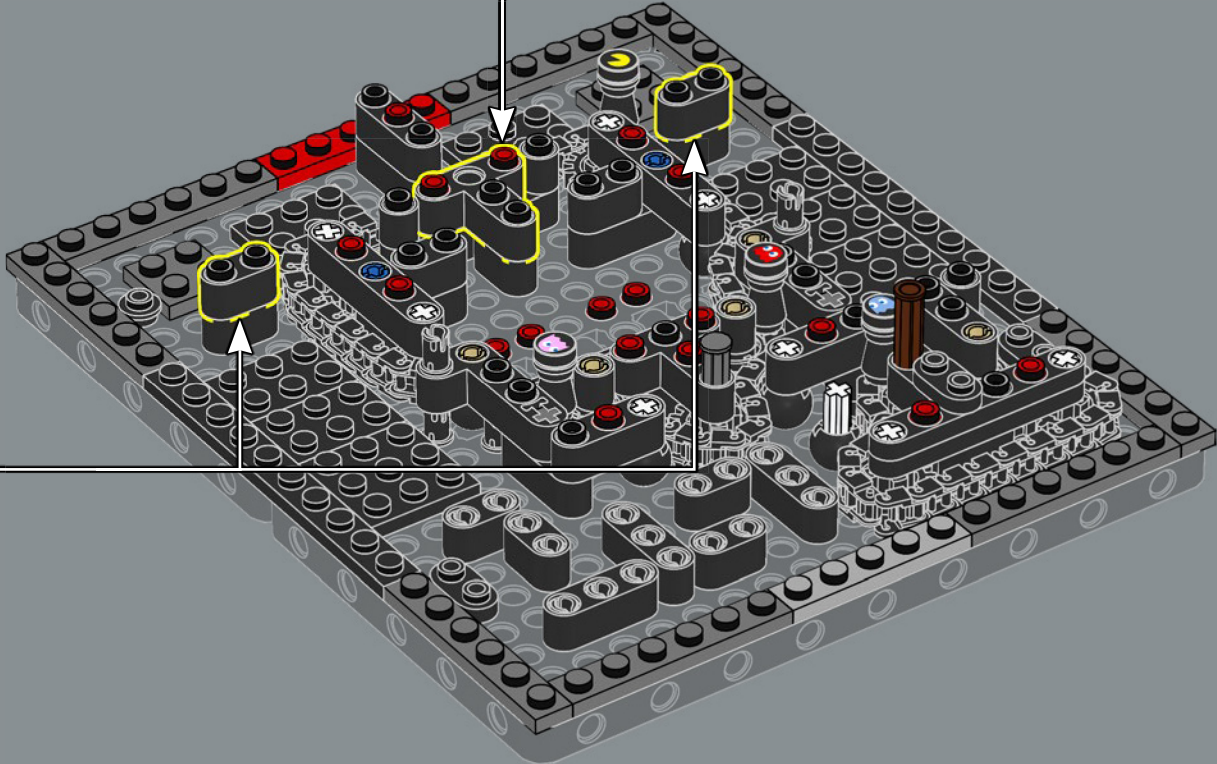
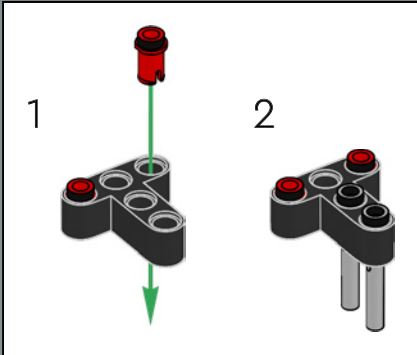



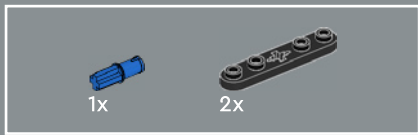

153

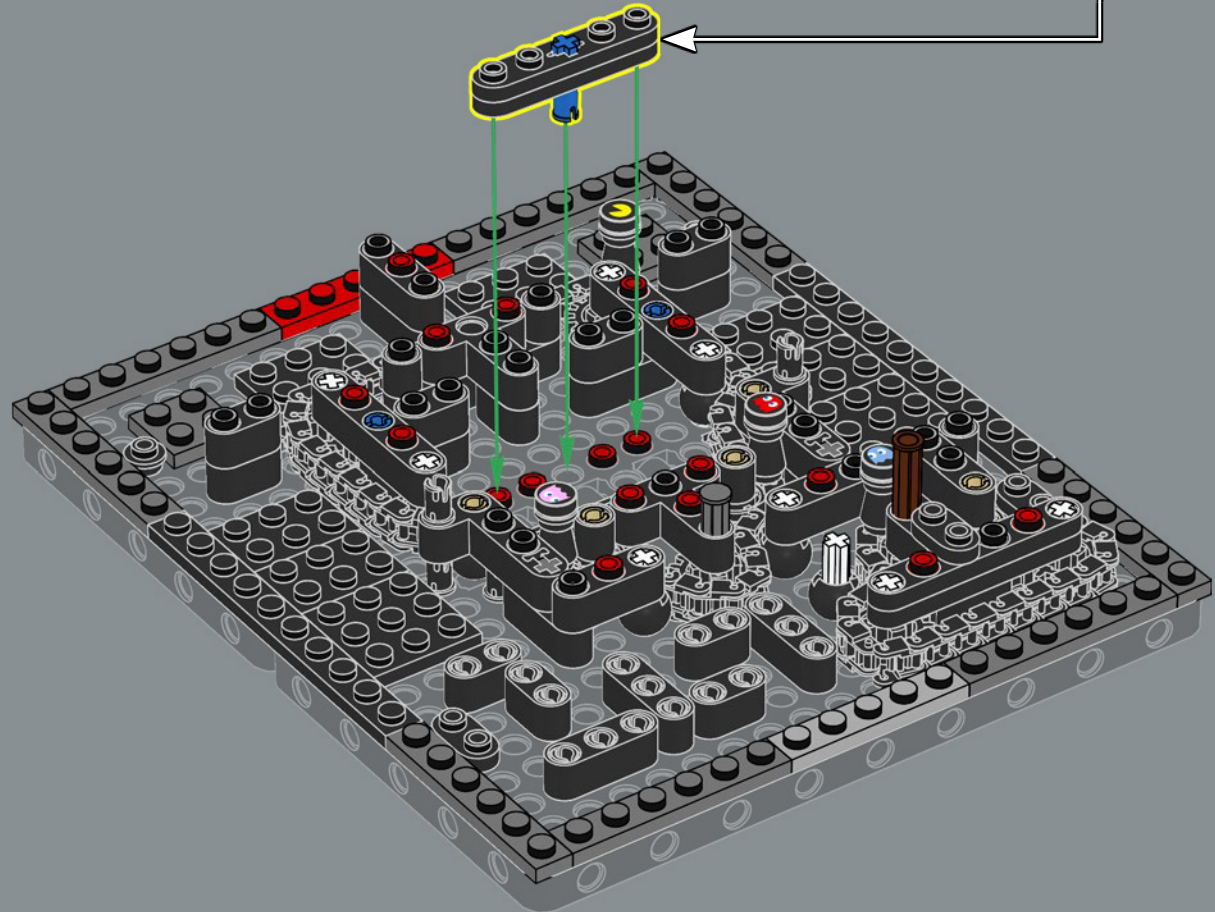
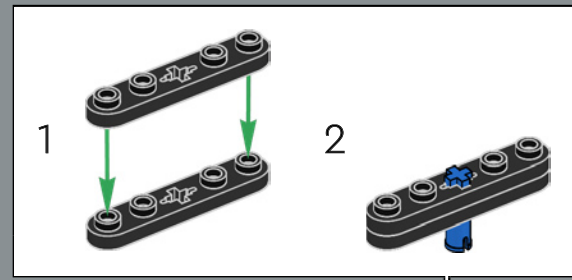



154

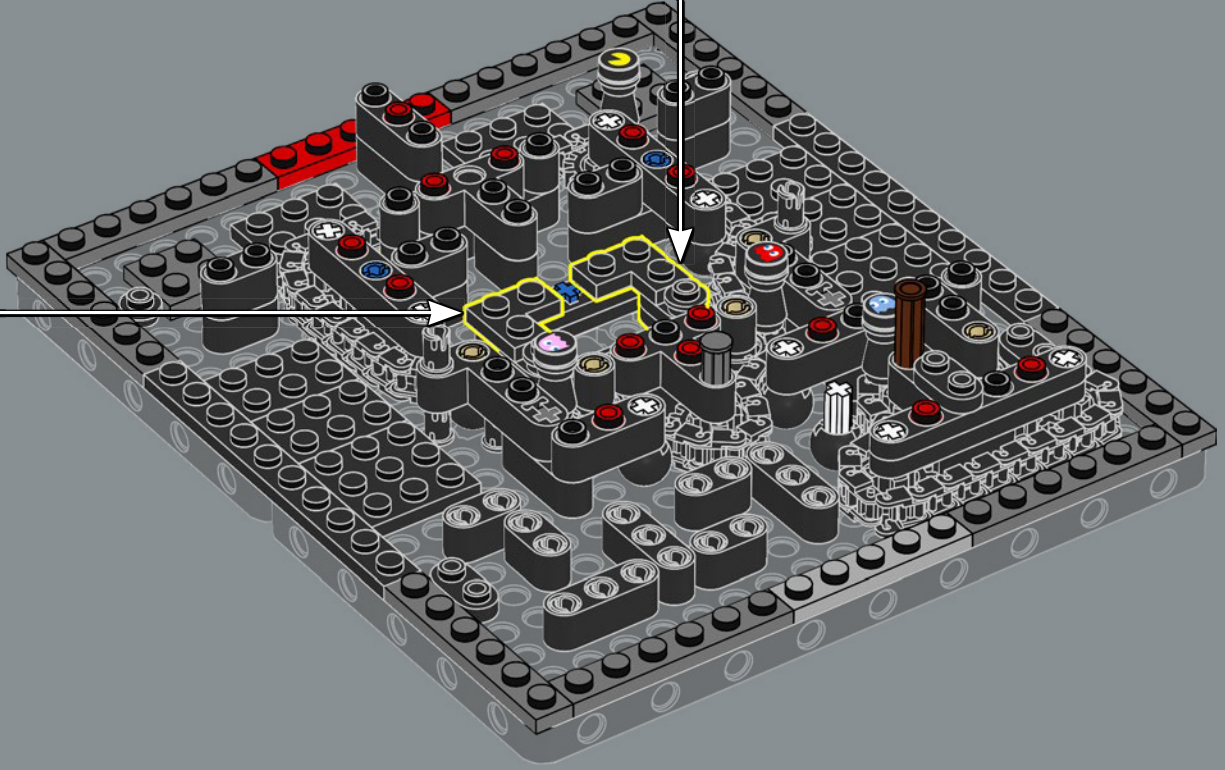
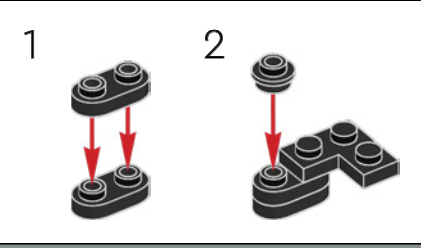
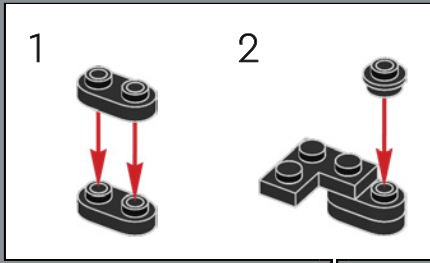

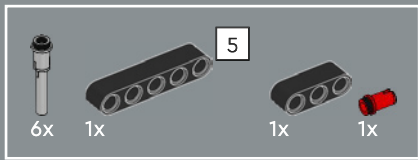

155

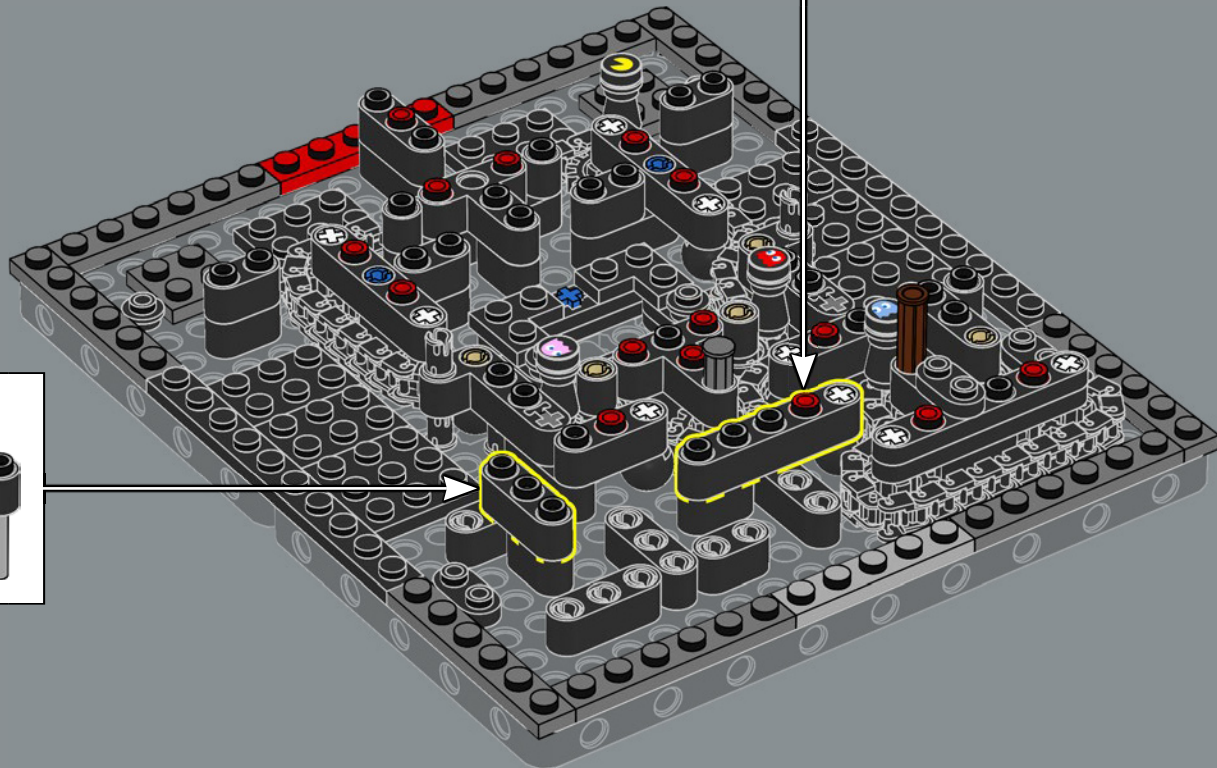
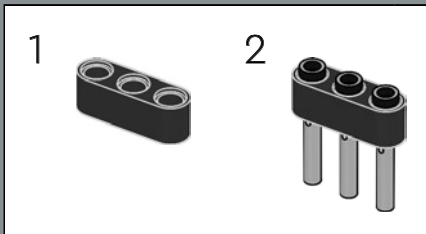
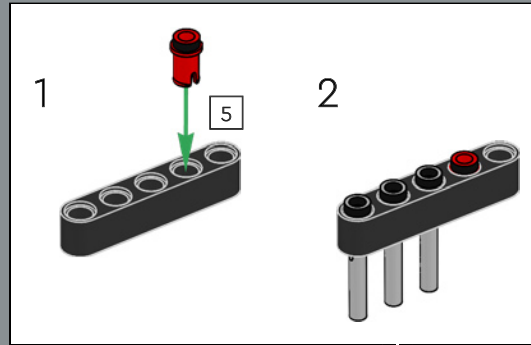

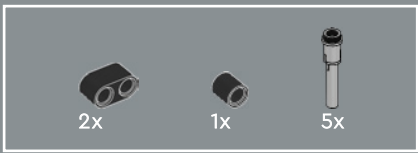

156

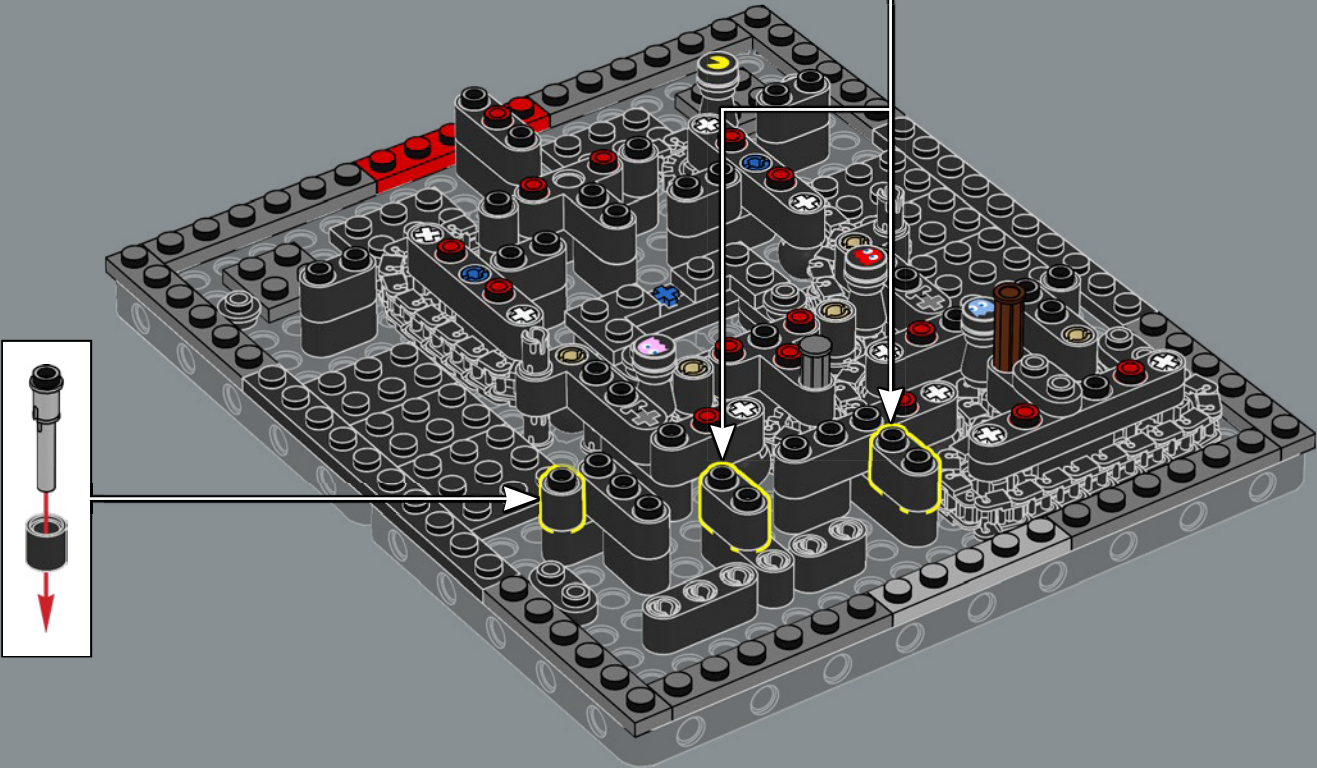
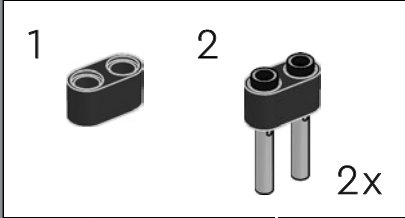

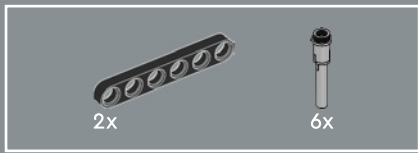

157

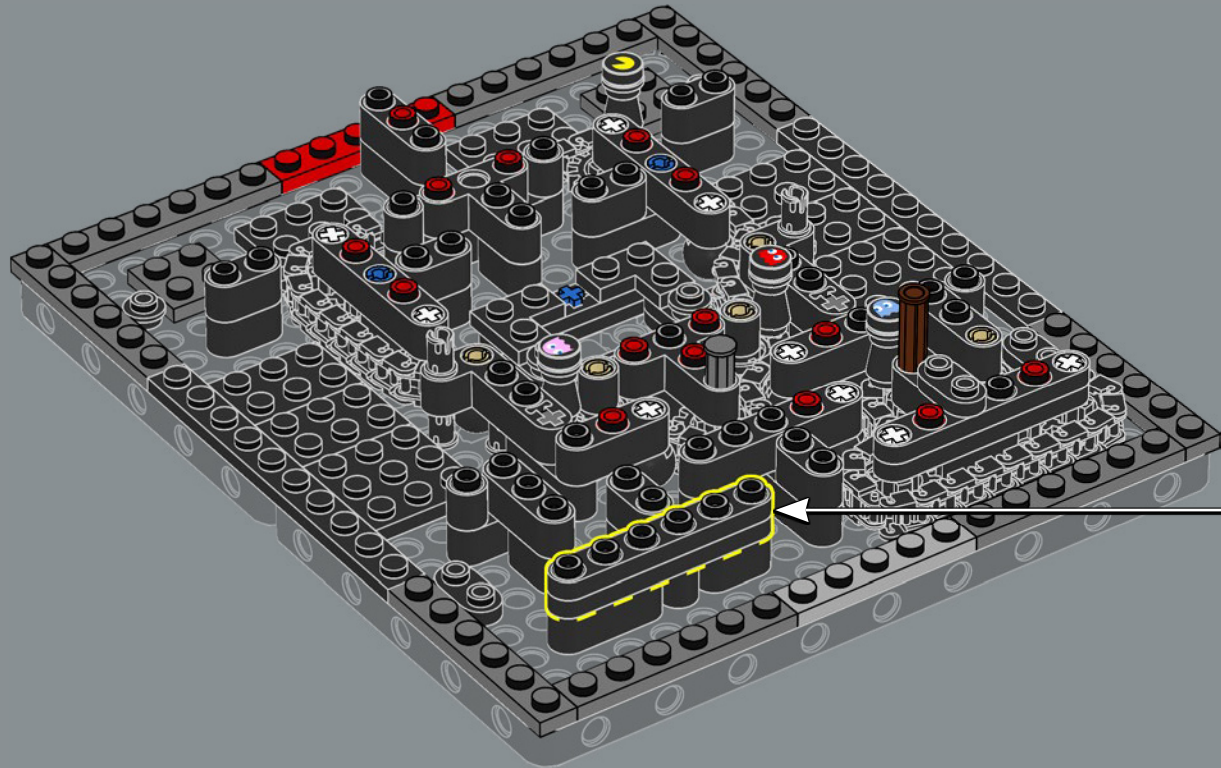
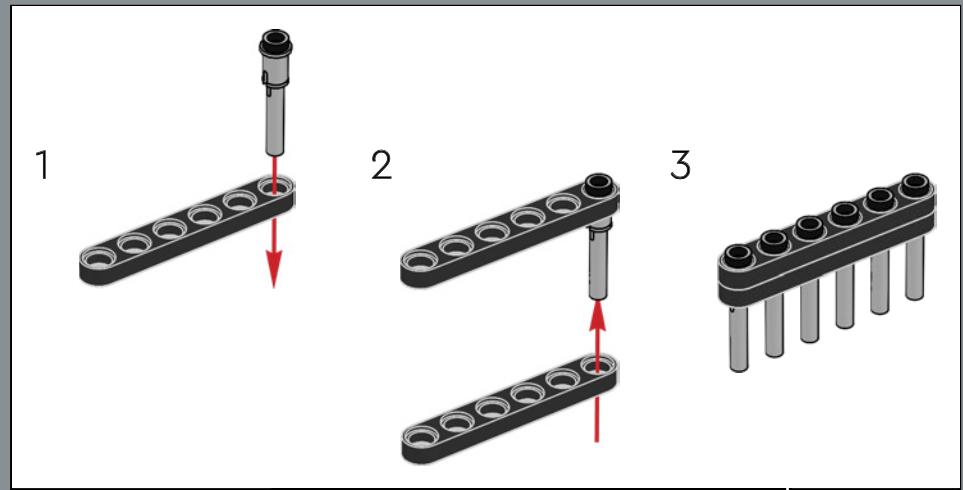



158

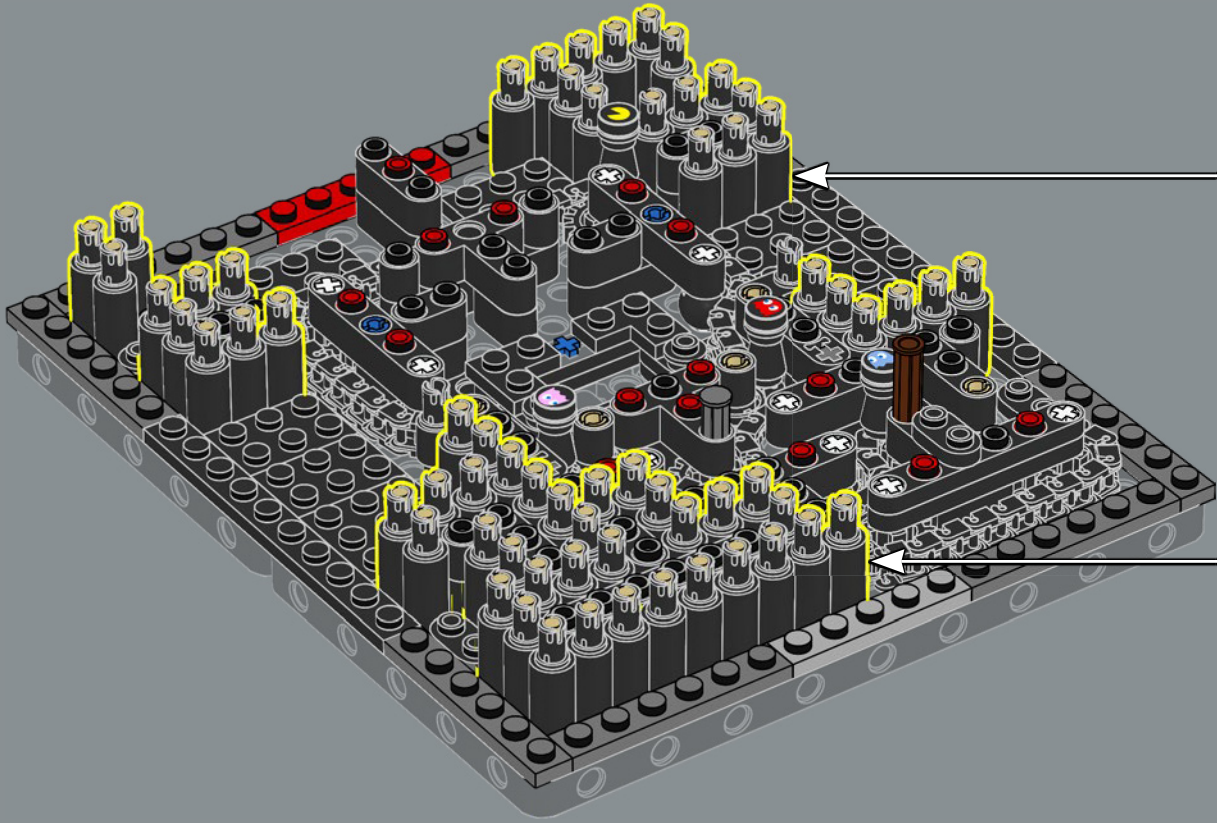
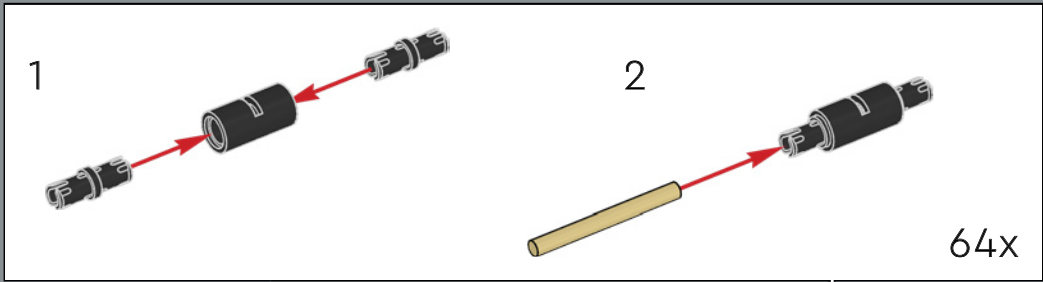

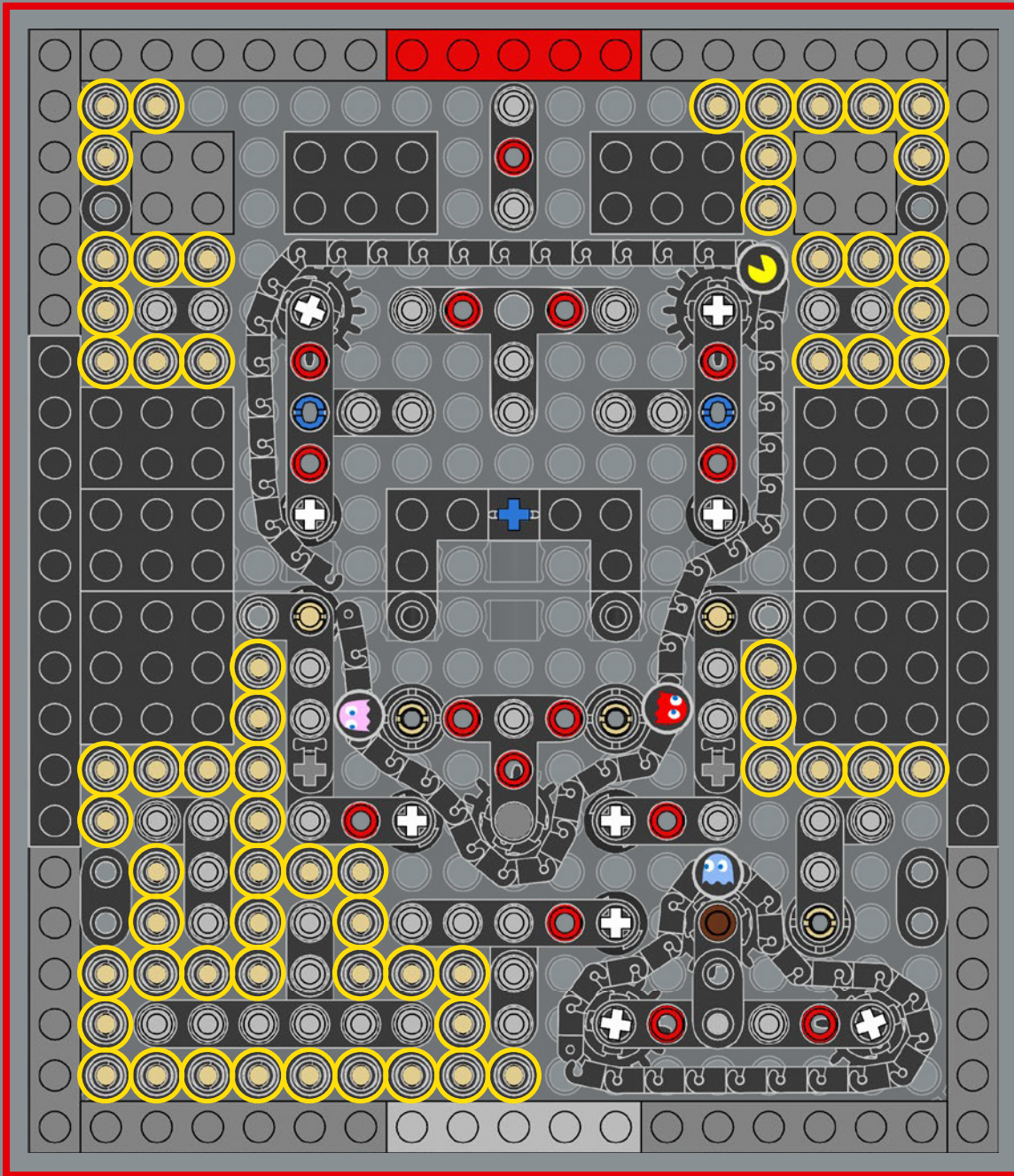



159

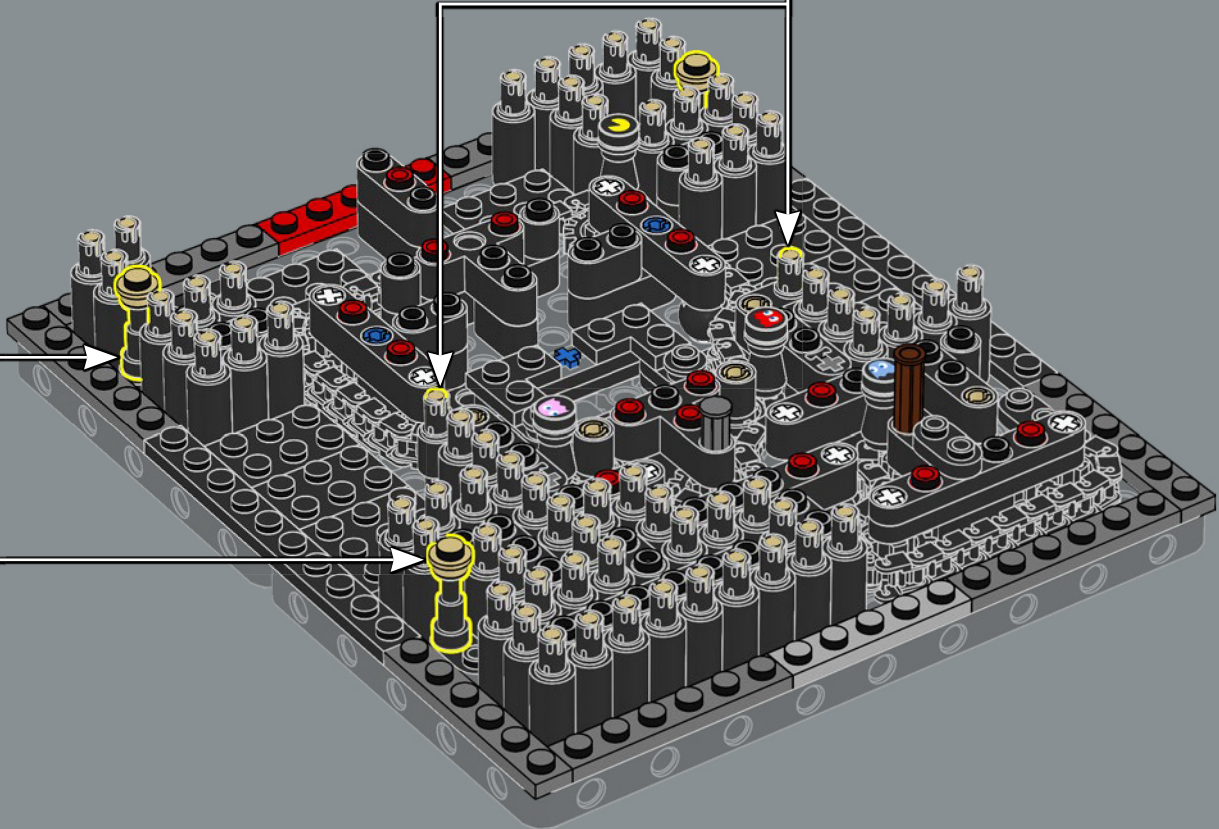
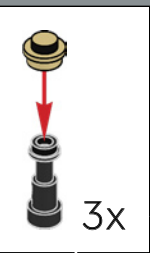
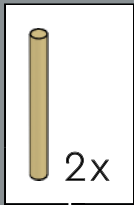



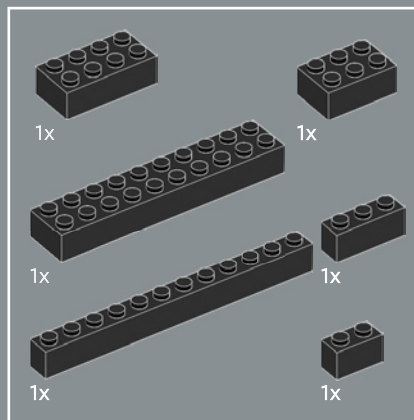

160

1

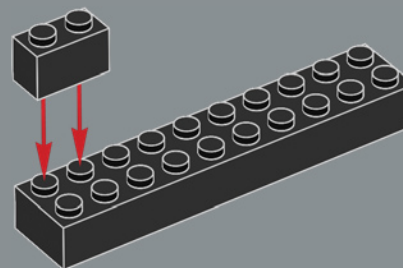

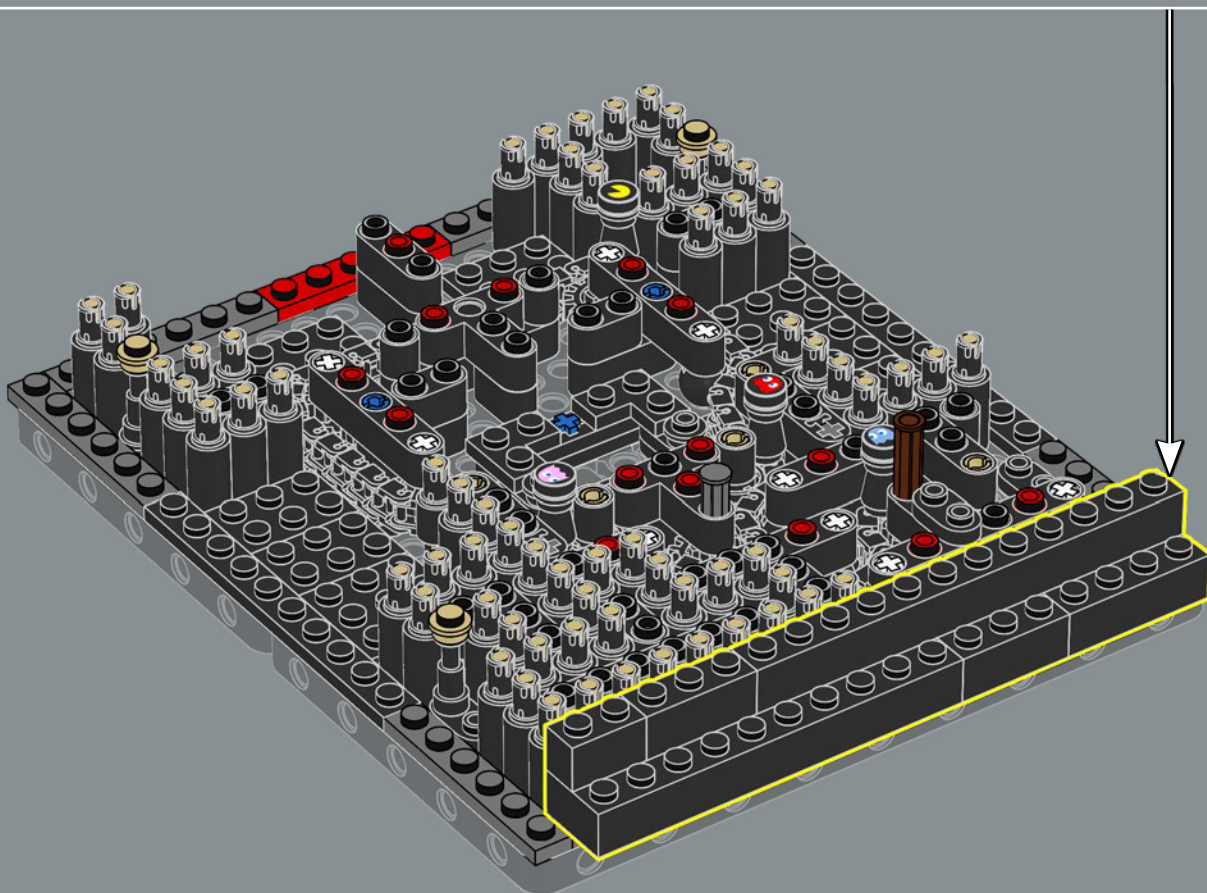
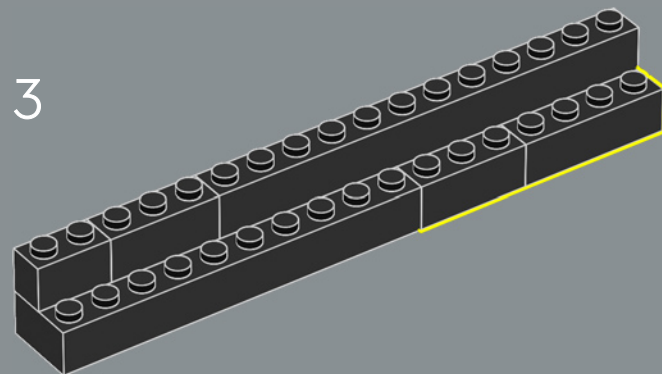
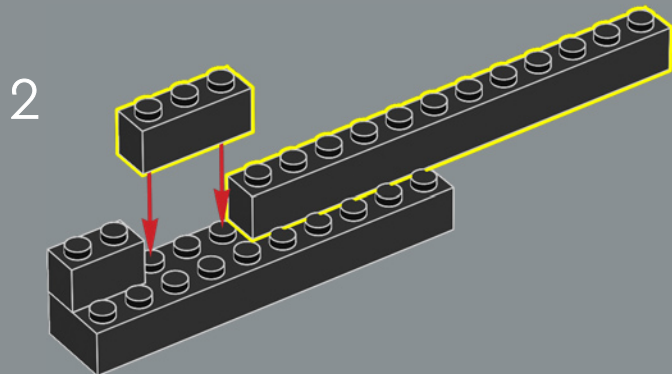

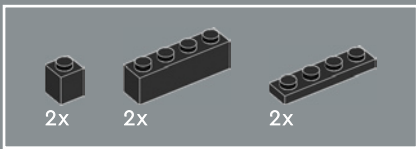

161

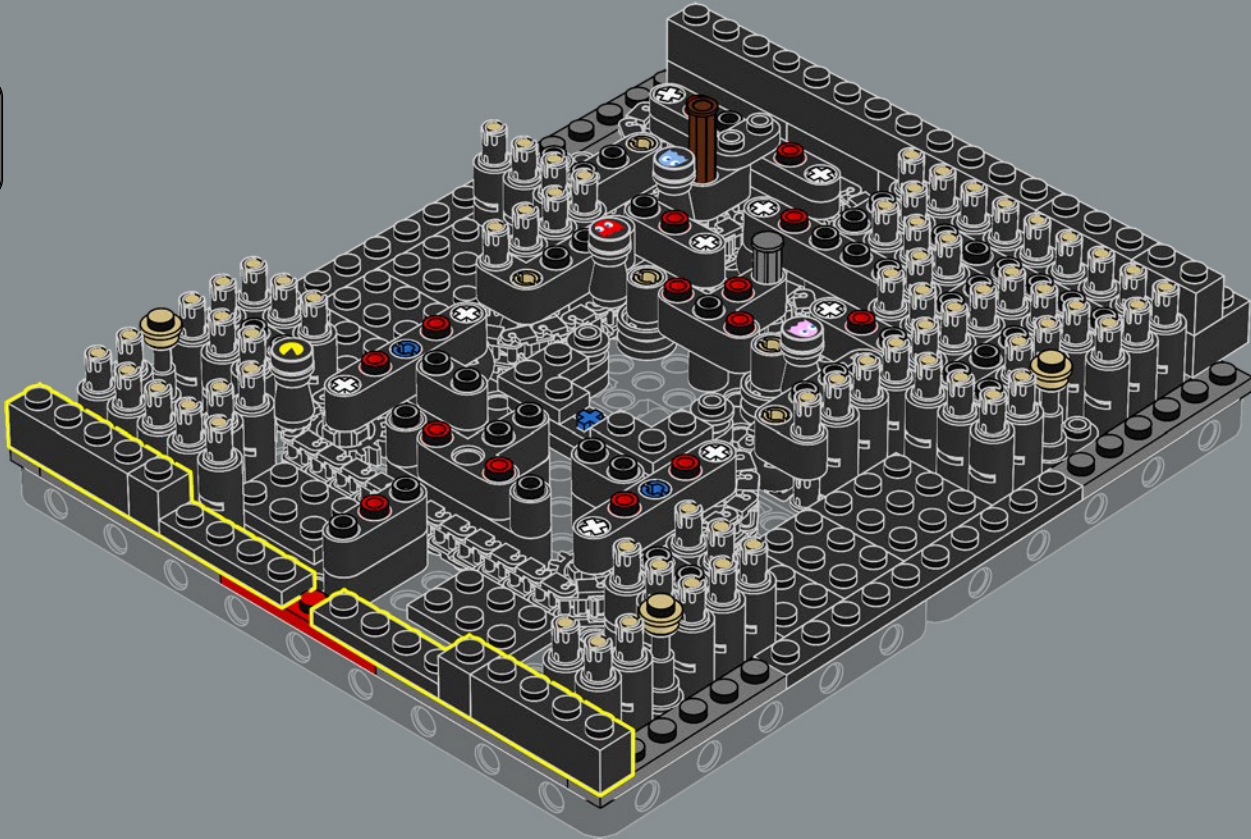

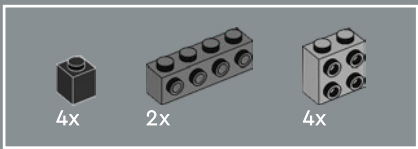

162

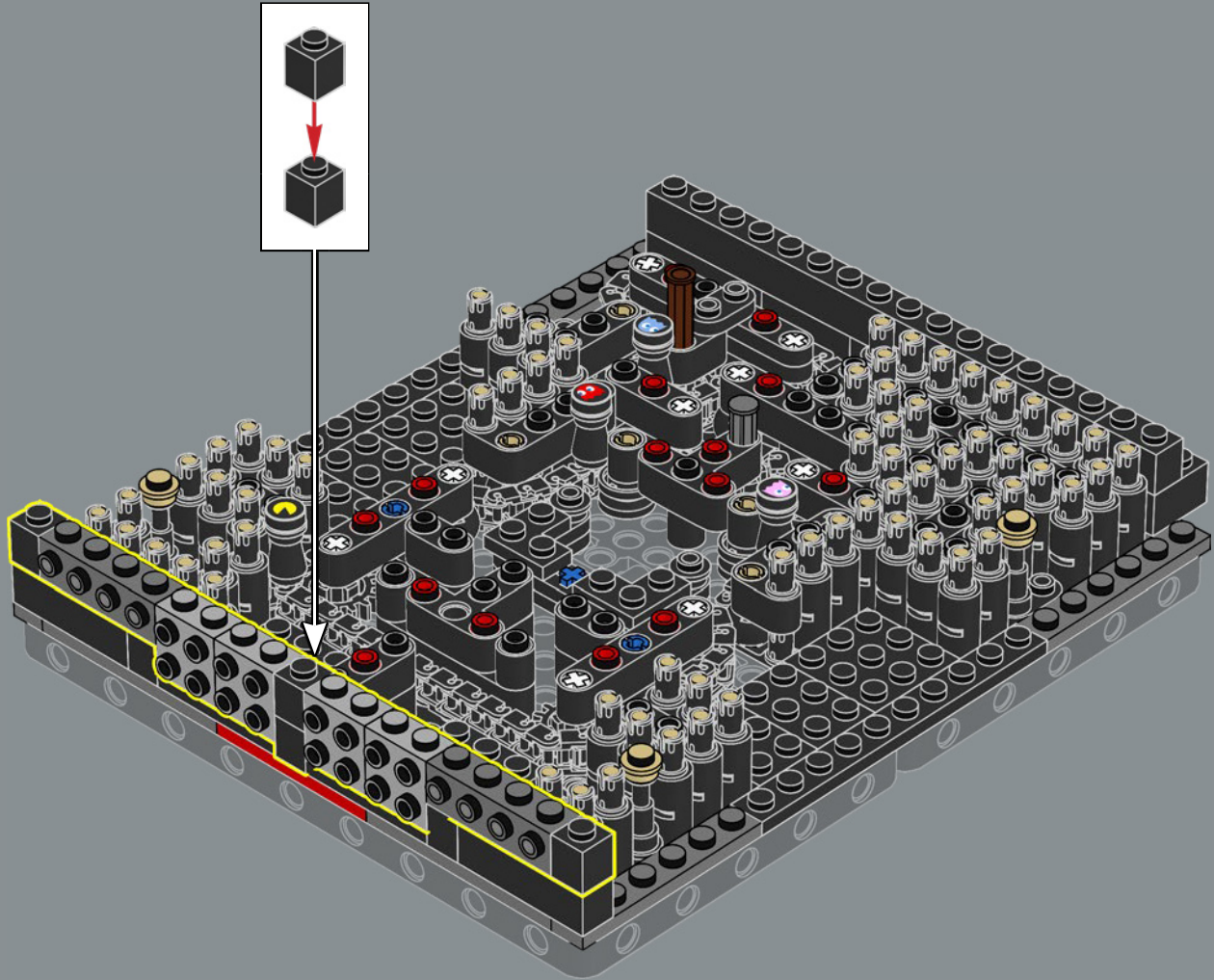

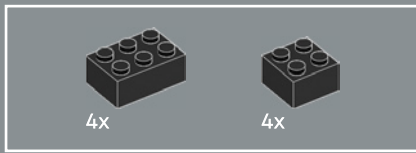

163

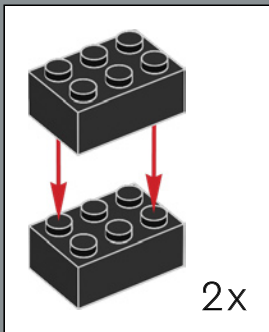
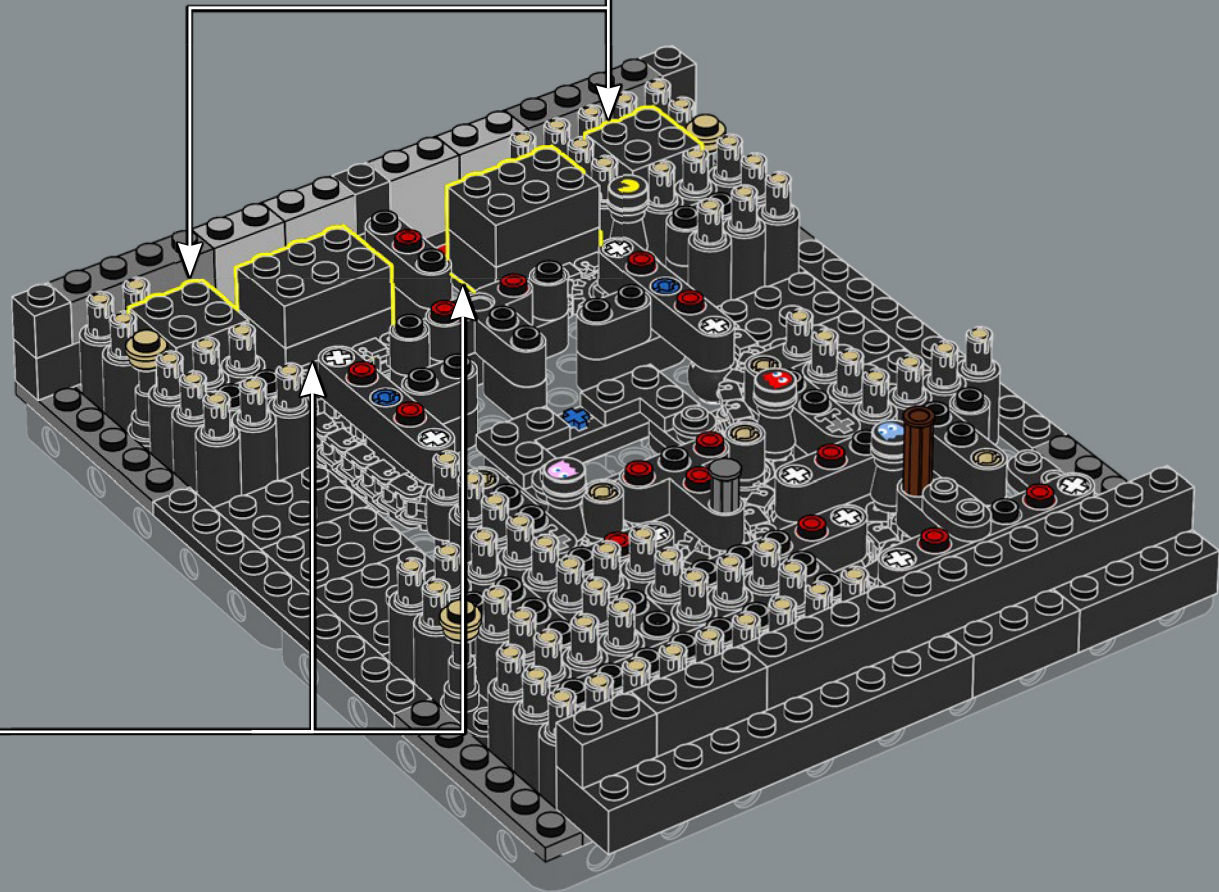
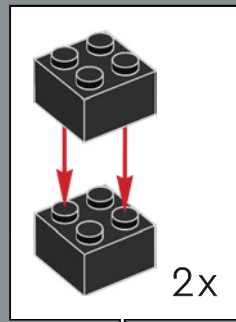

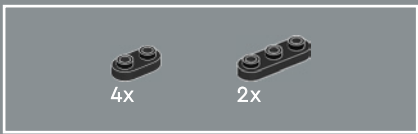

164

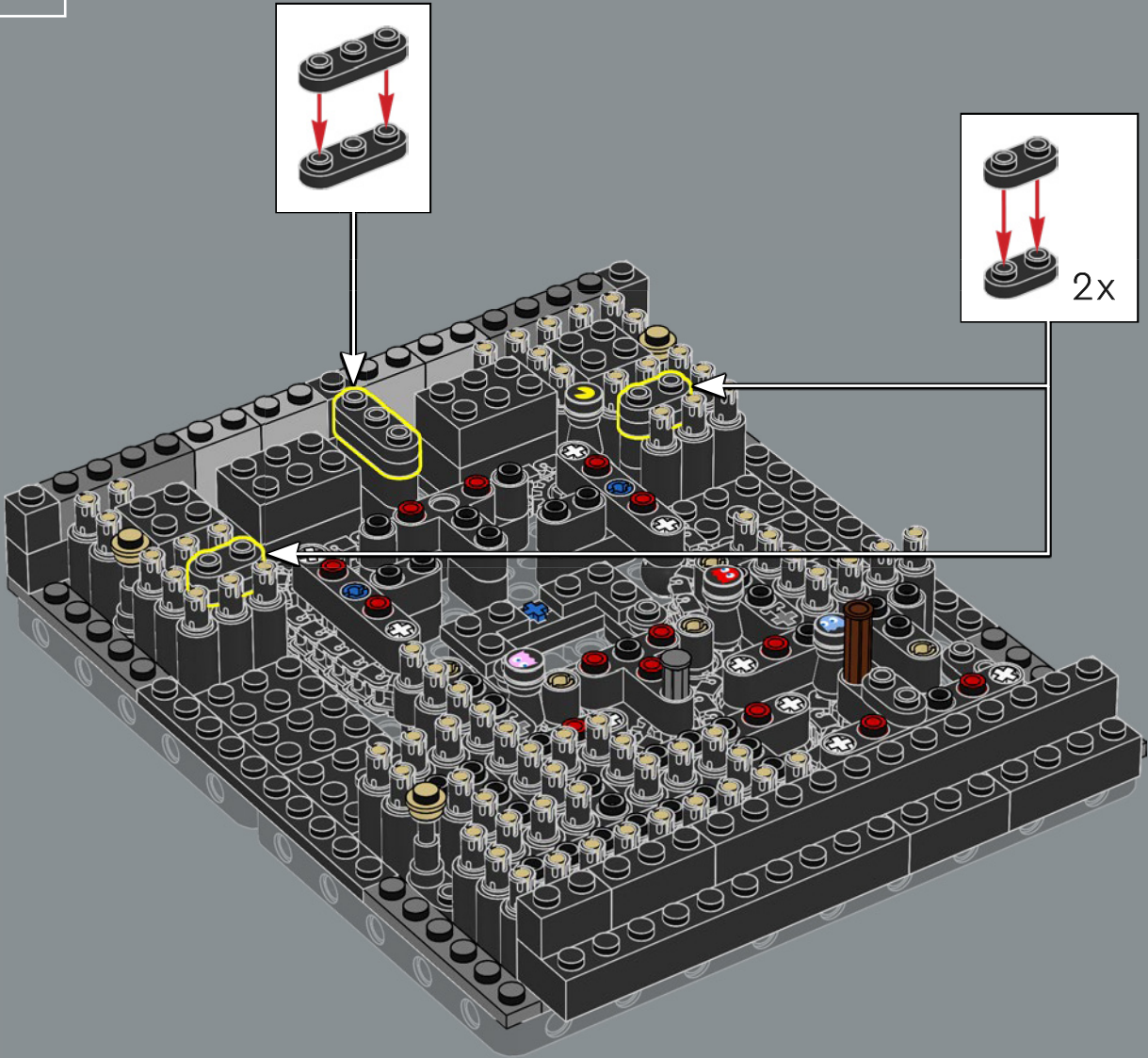

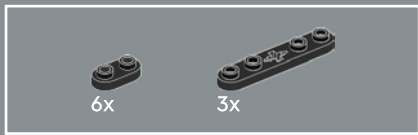

165

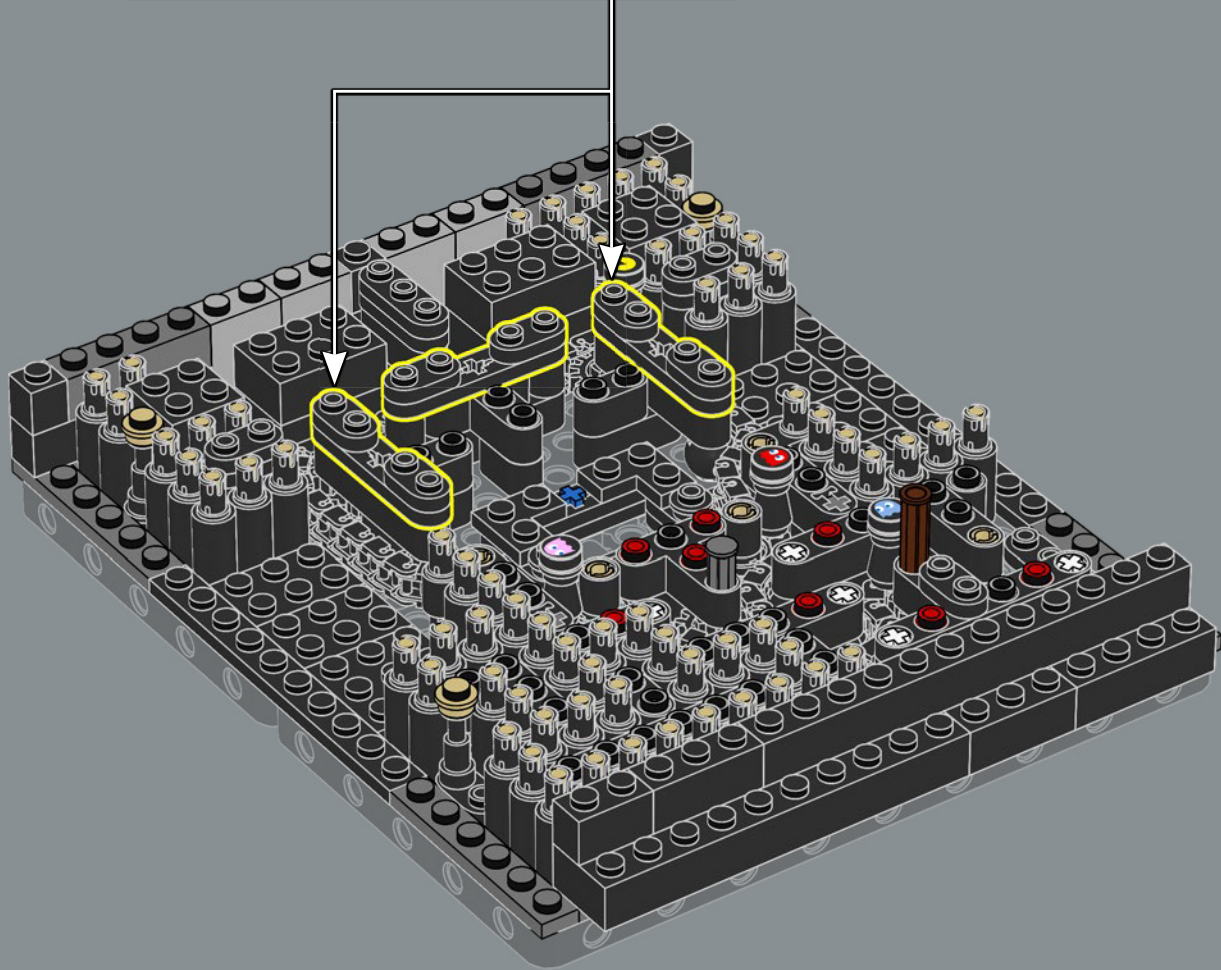
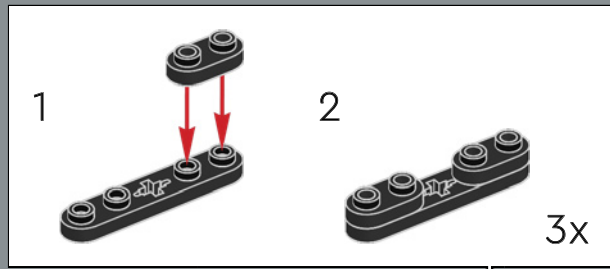

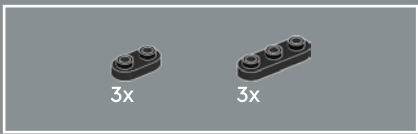

166

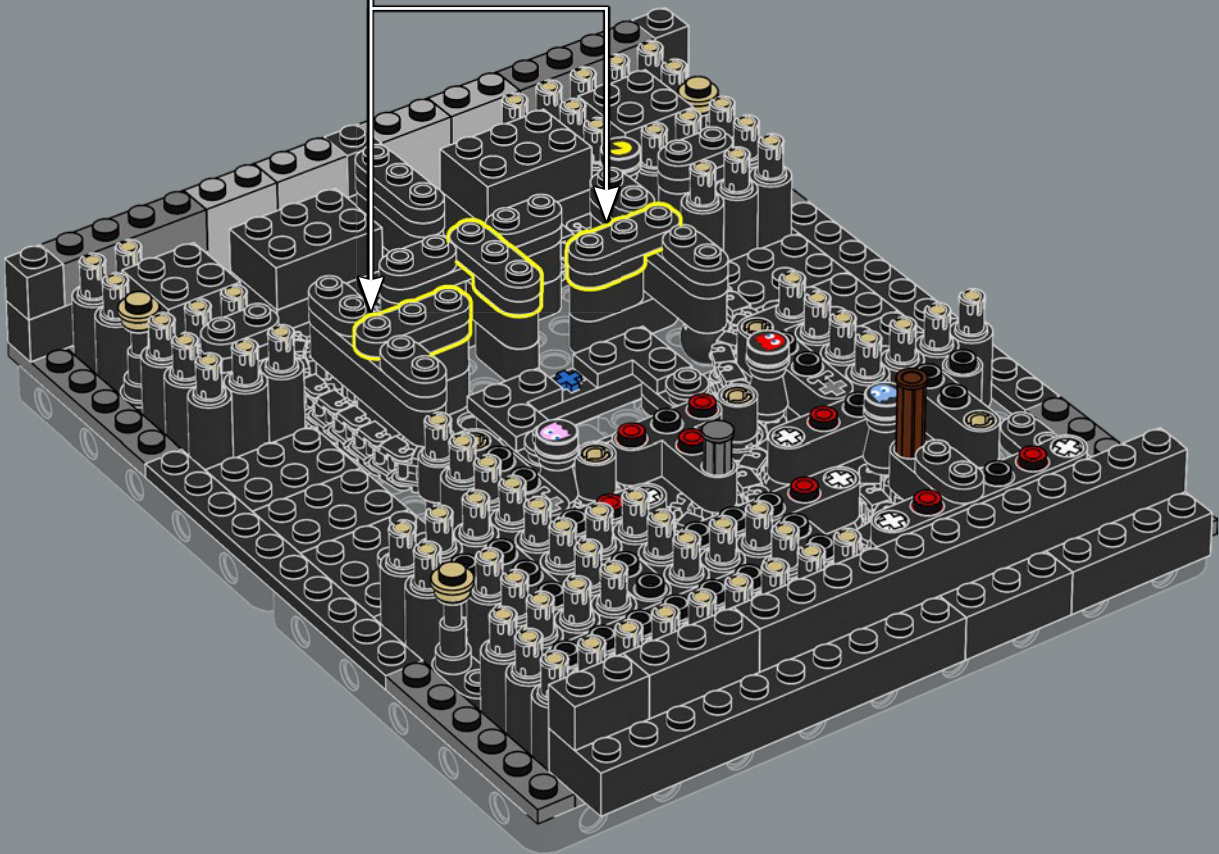
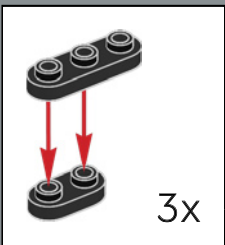





167

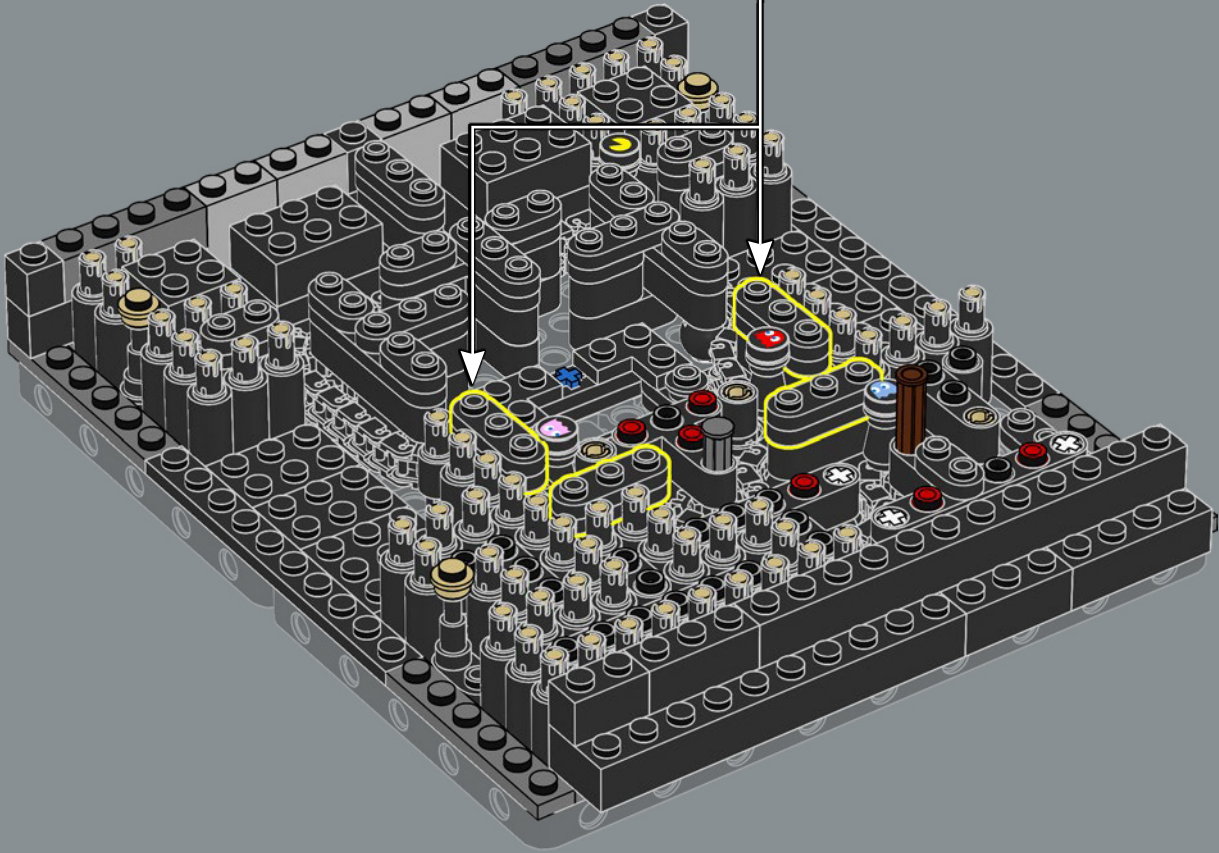
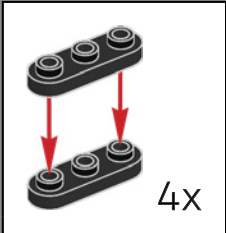



168

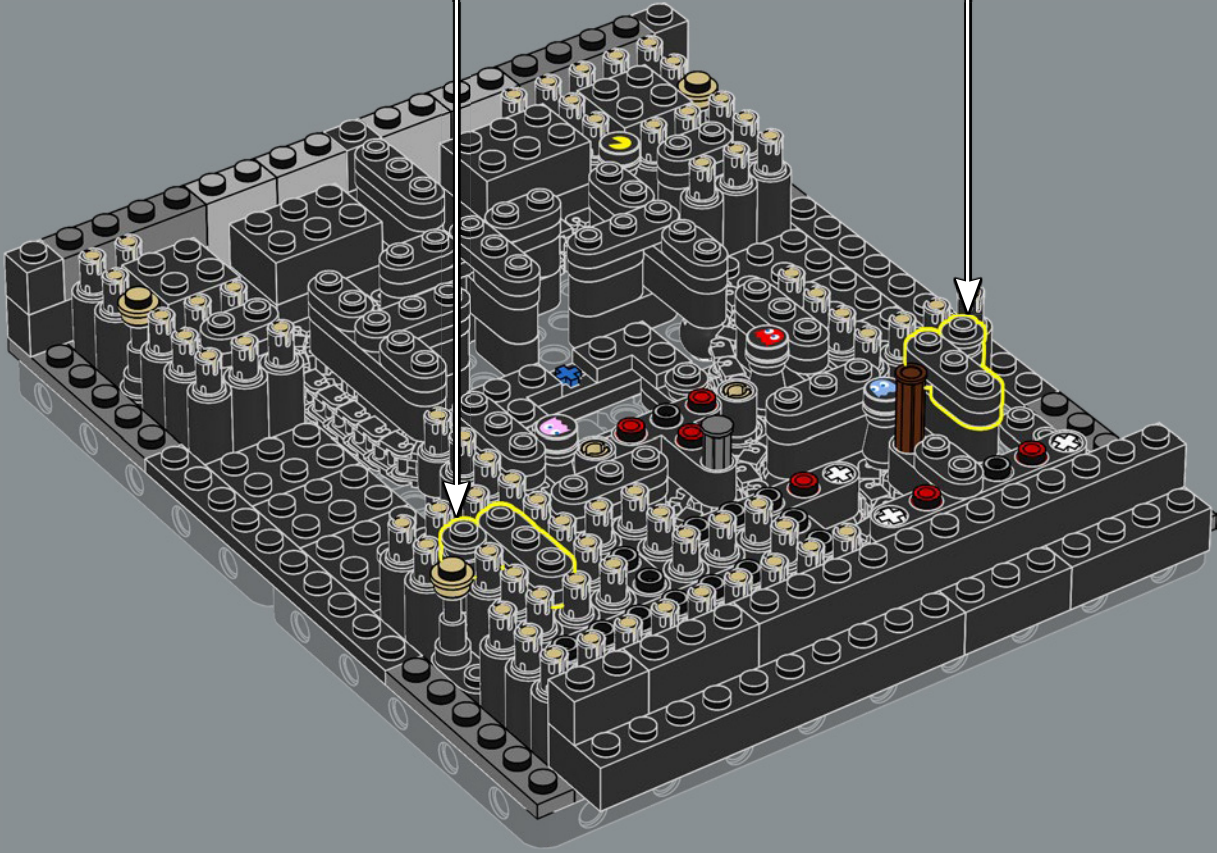
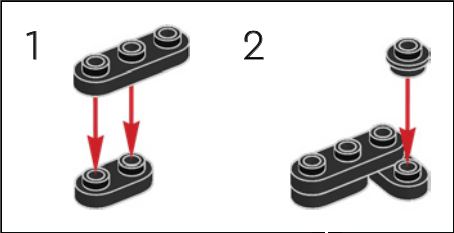
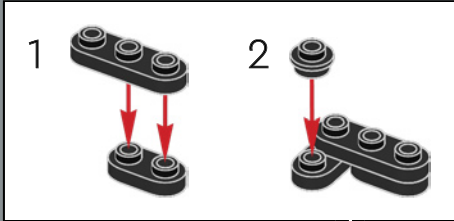



169

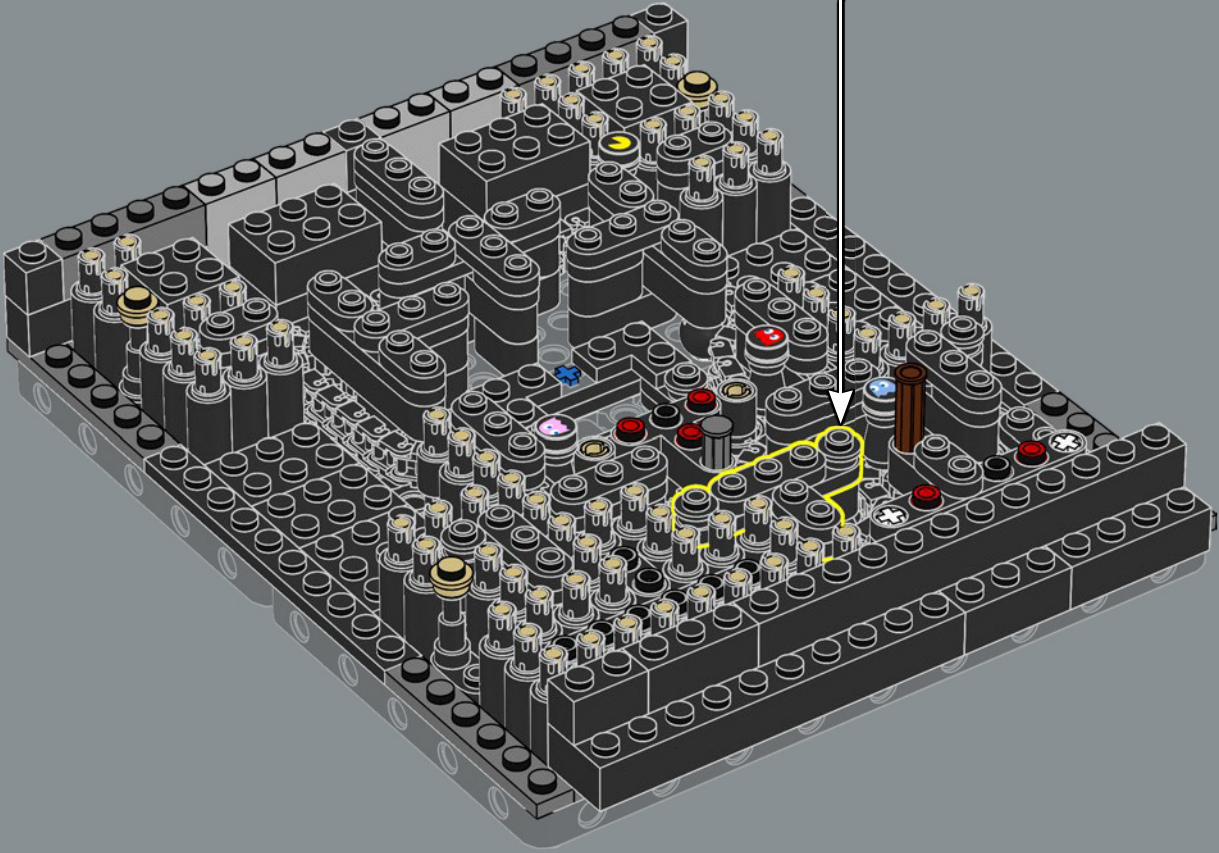
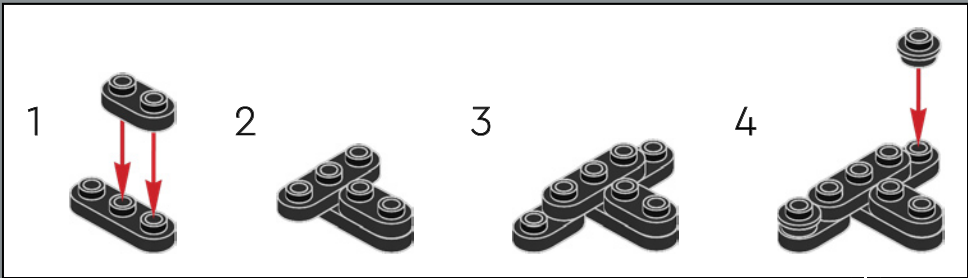

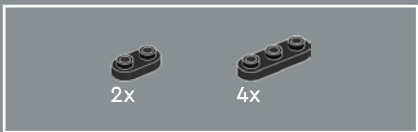

170

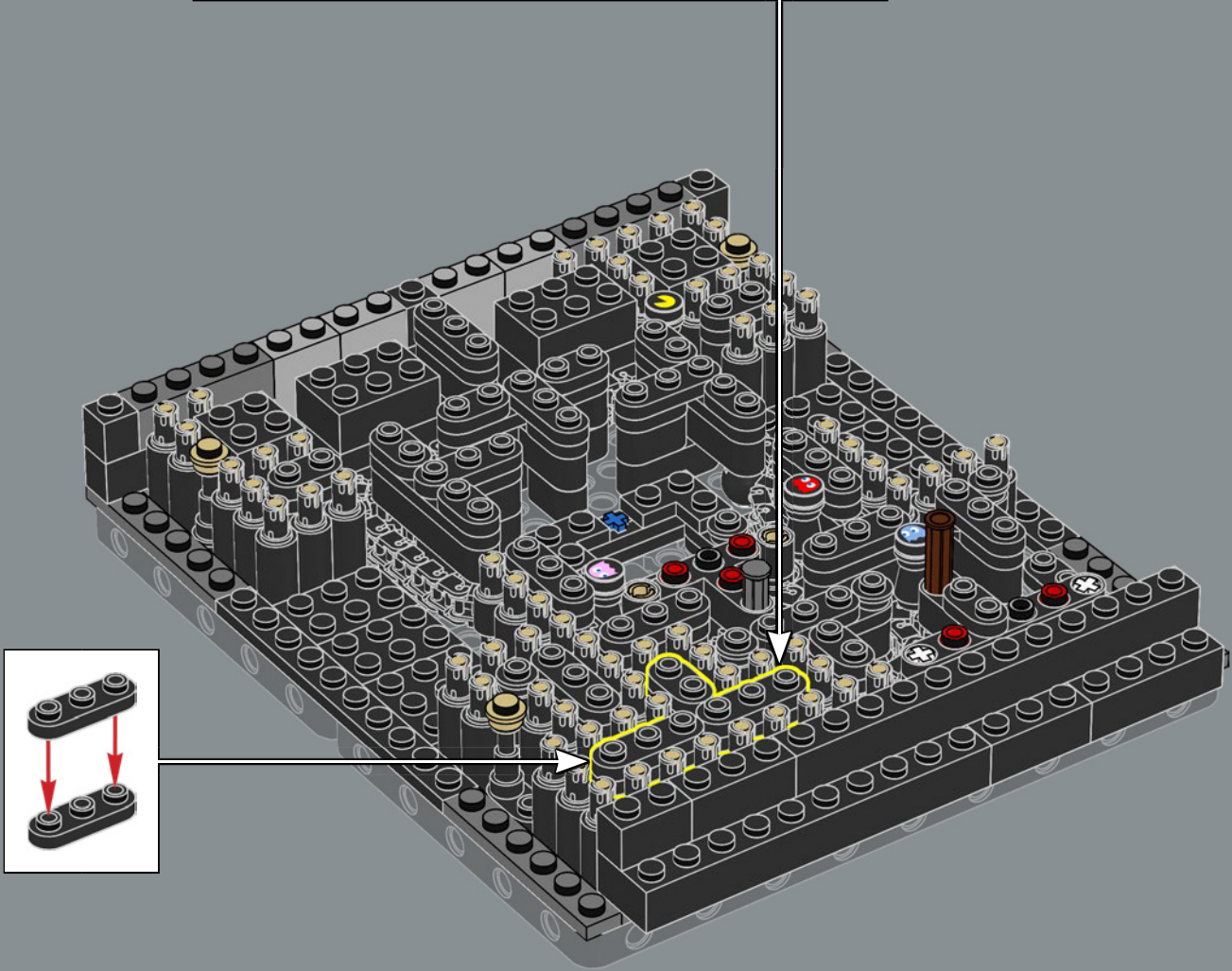
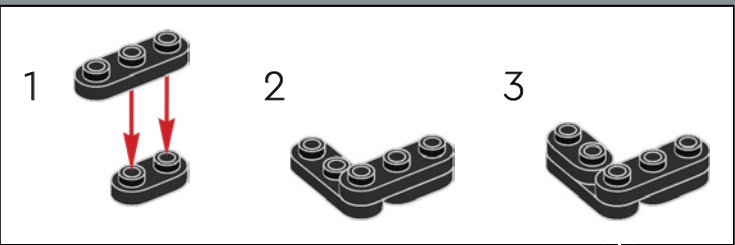

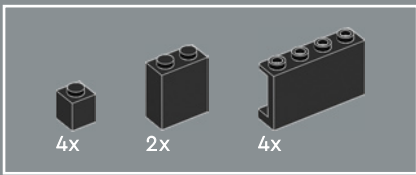

171

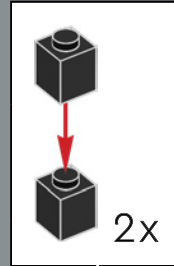
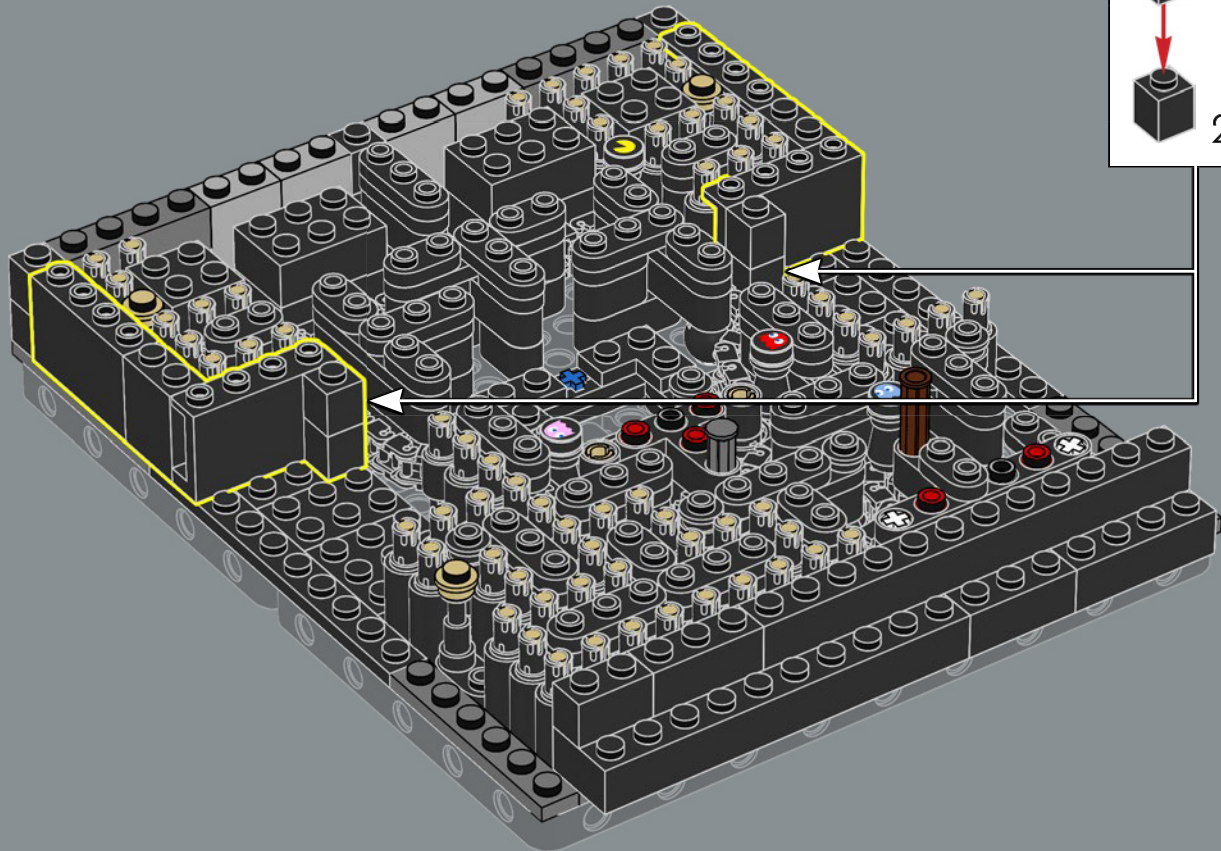

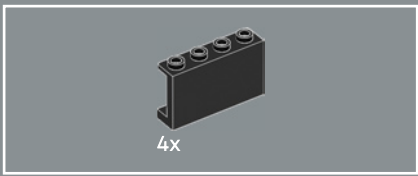

172

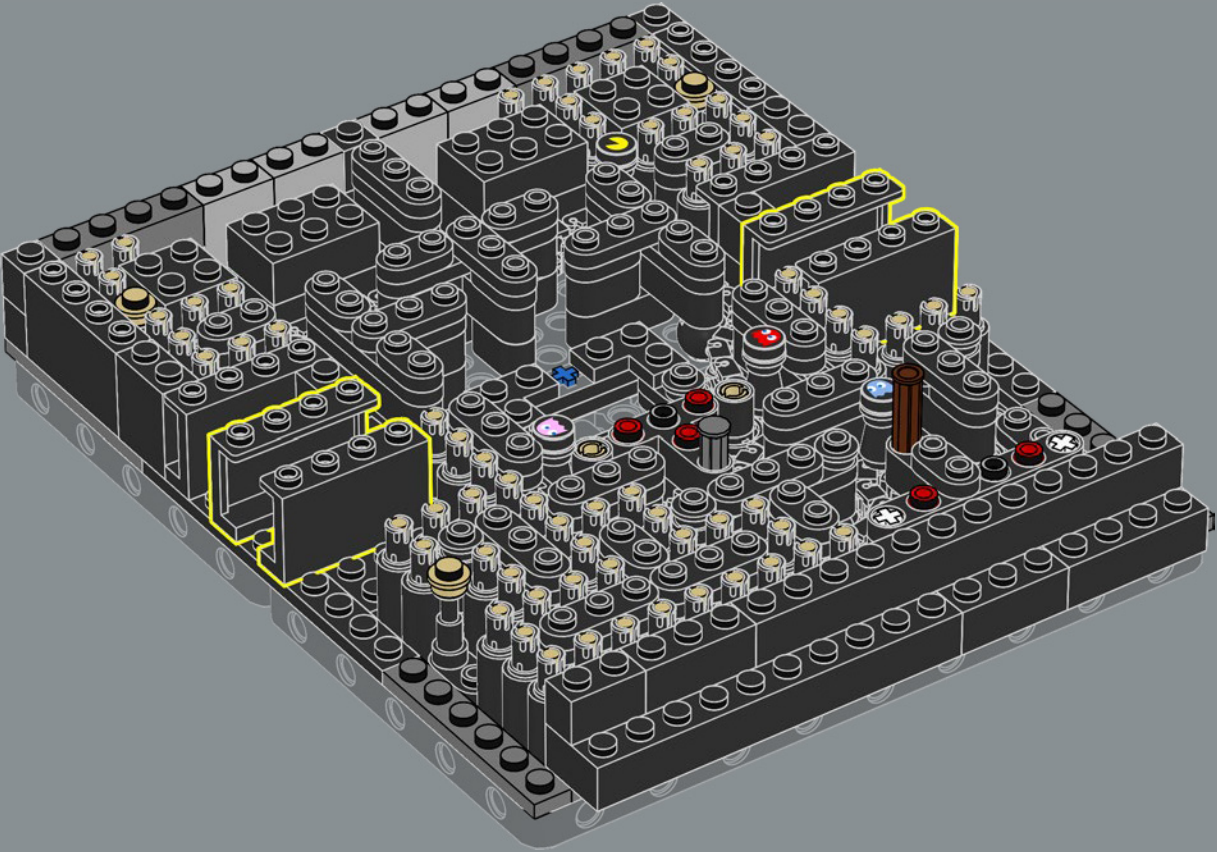

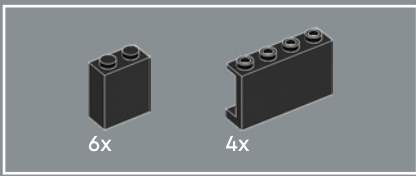

173

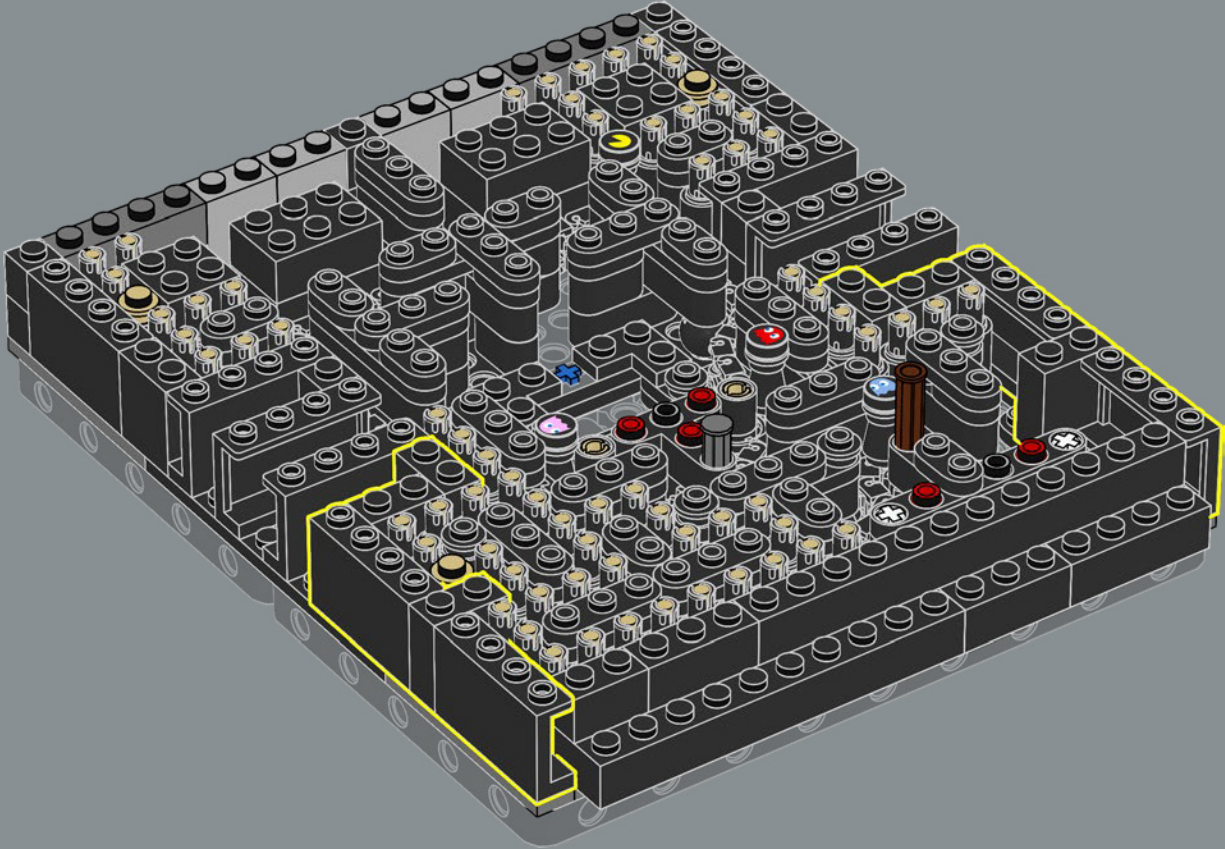

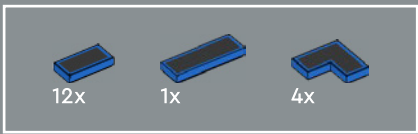

174

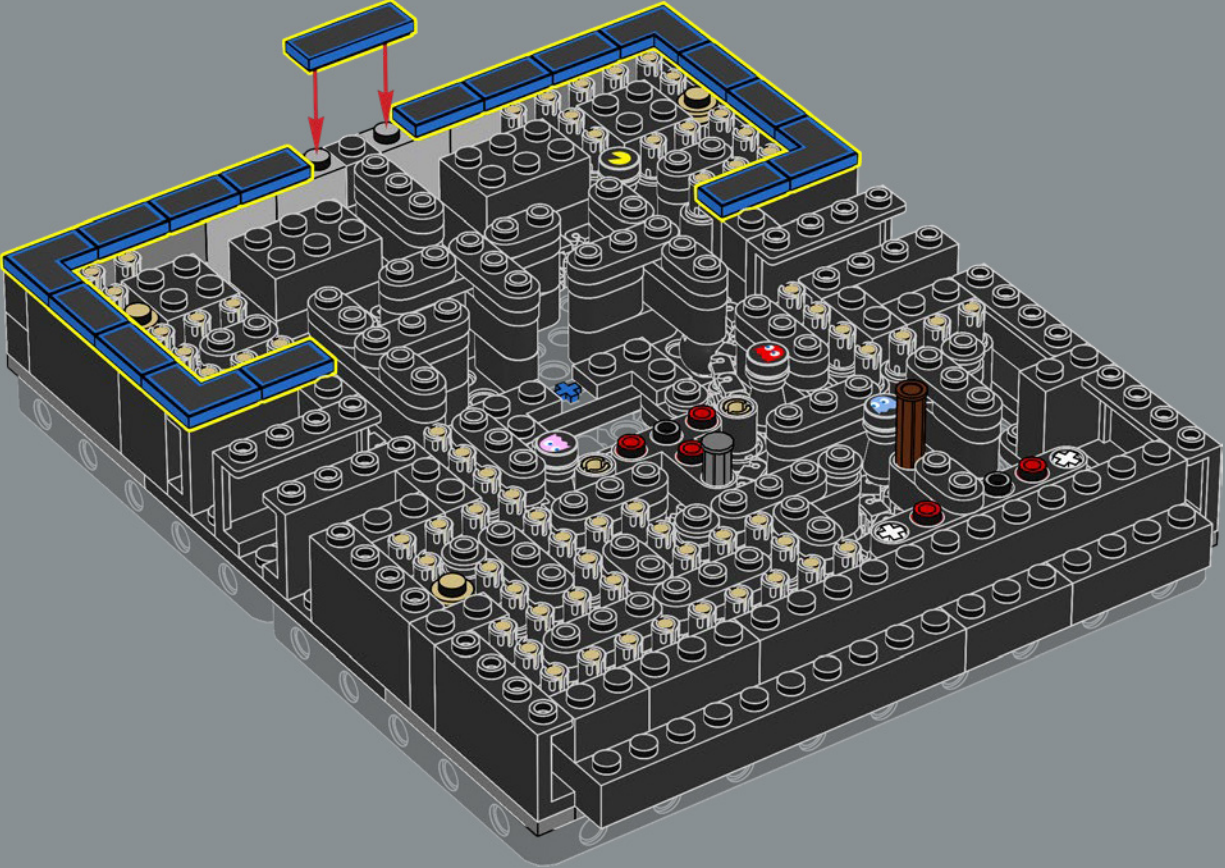



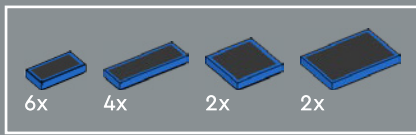

175

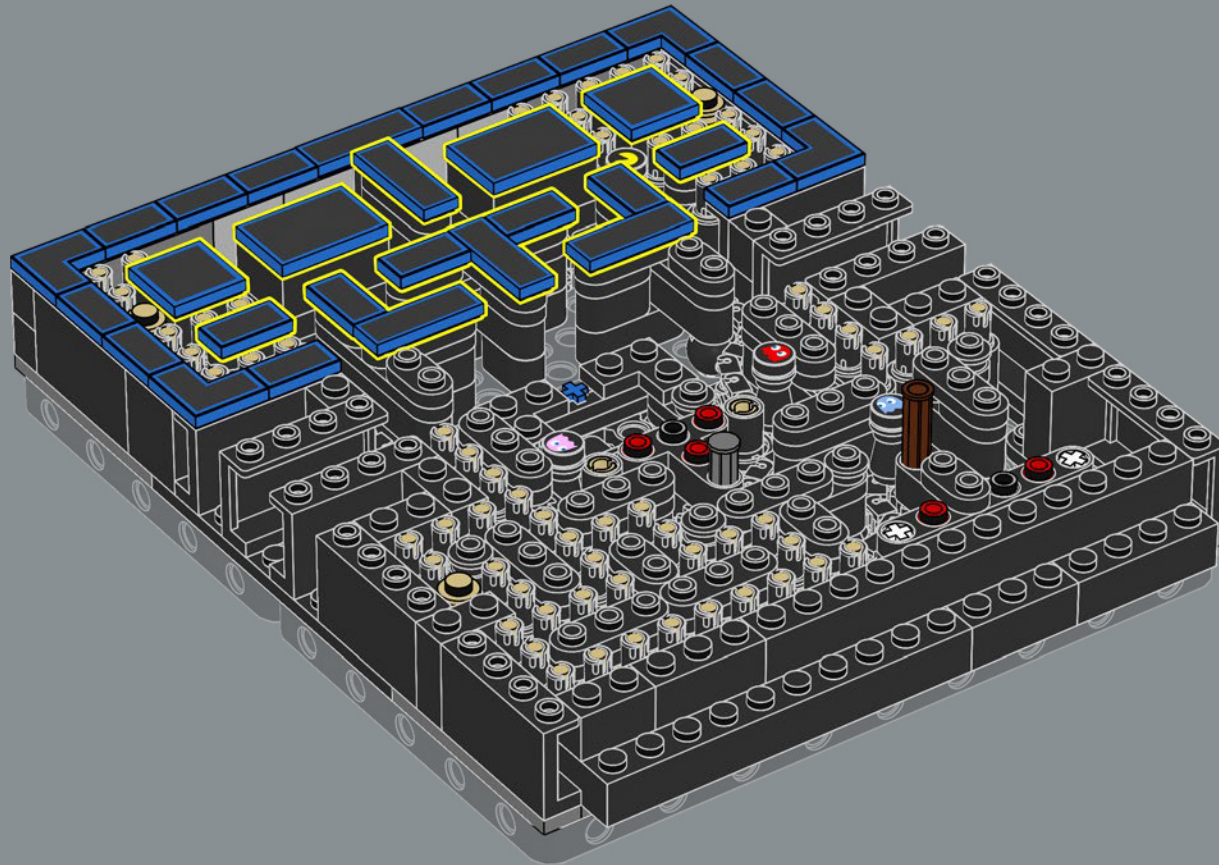

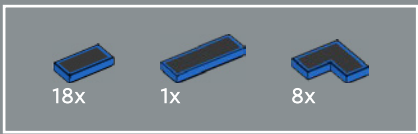

176

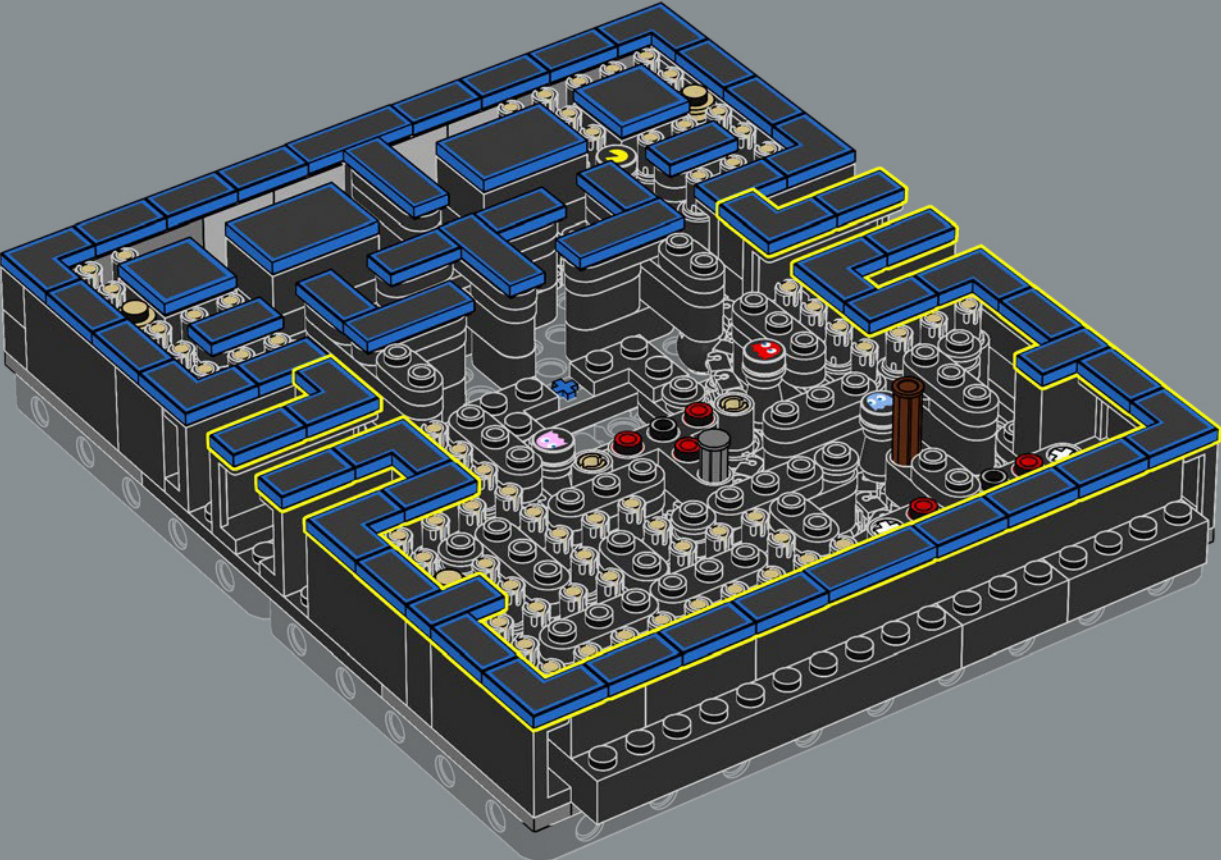

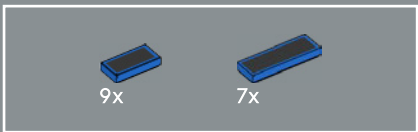

177

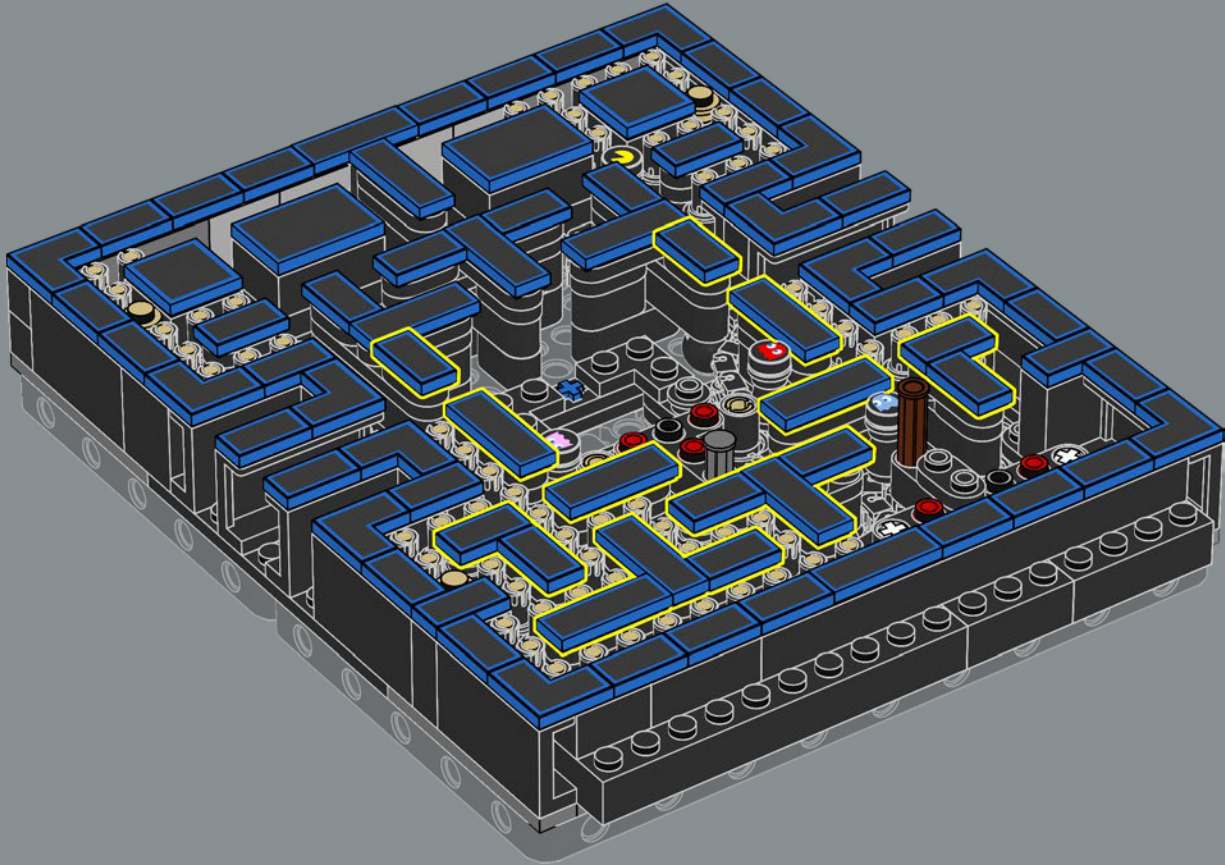



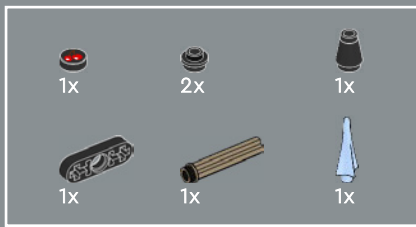

178

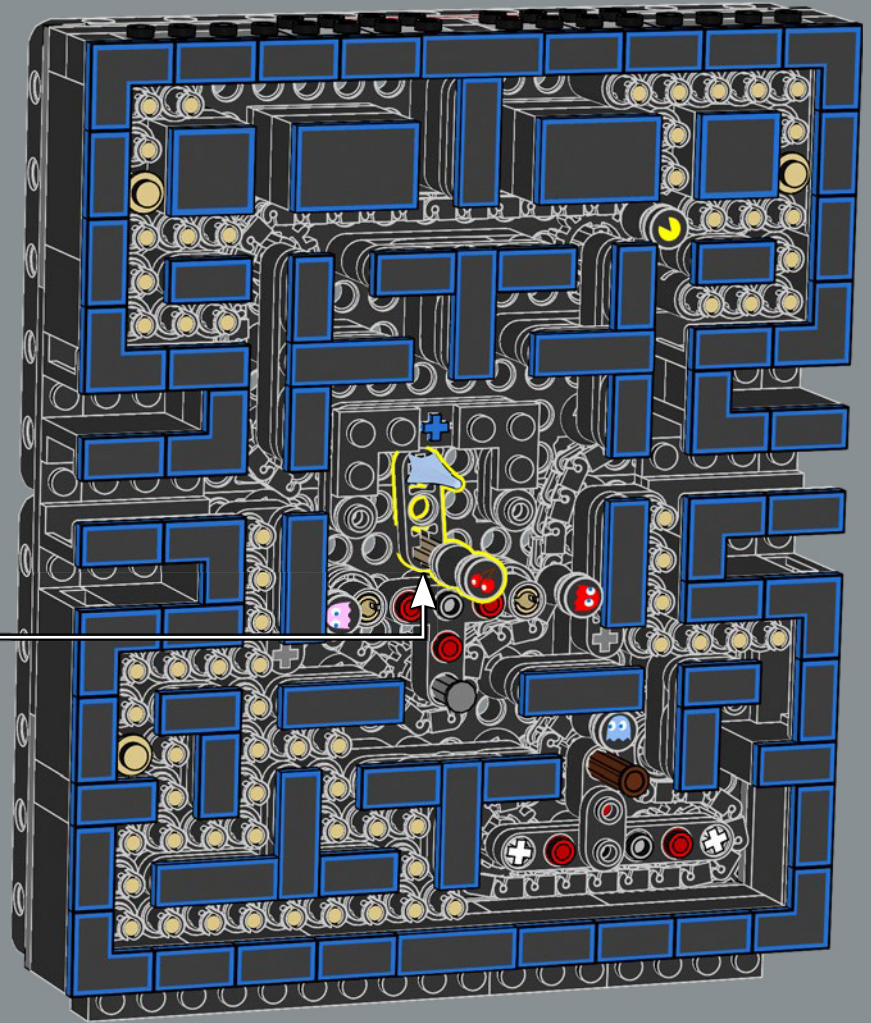
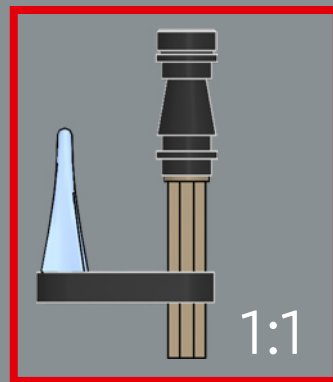
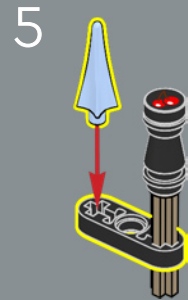
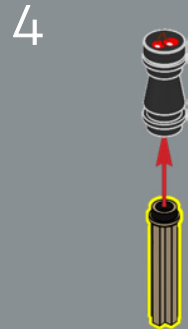
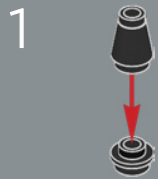

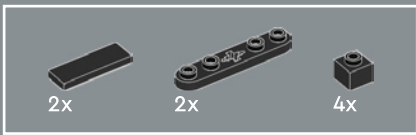

179

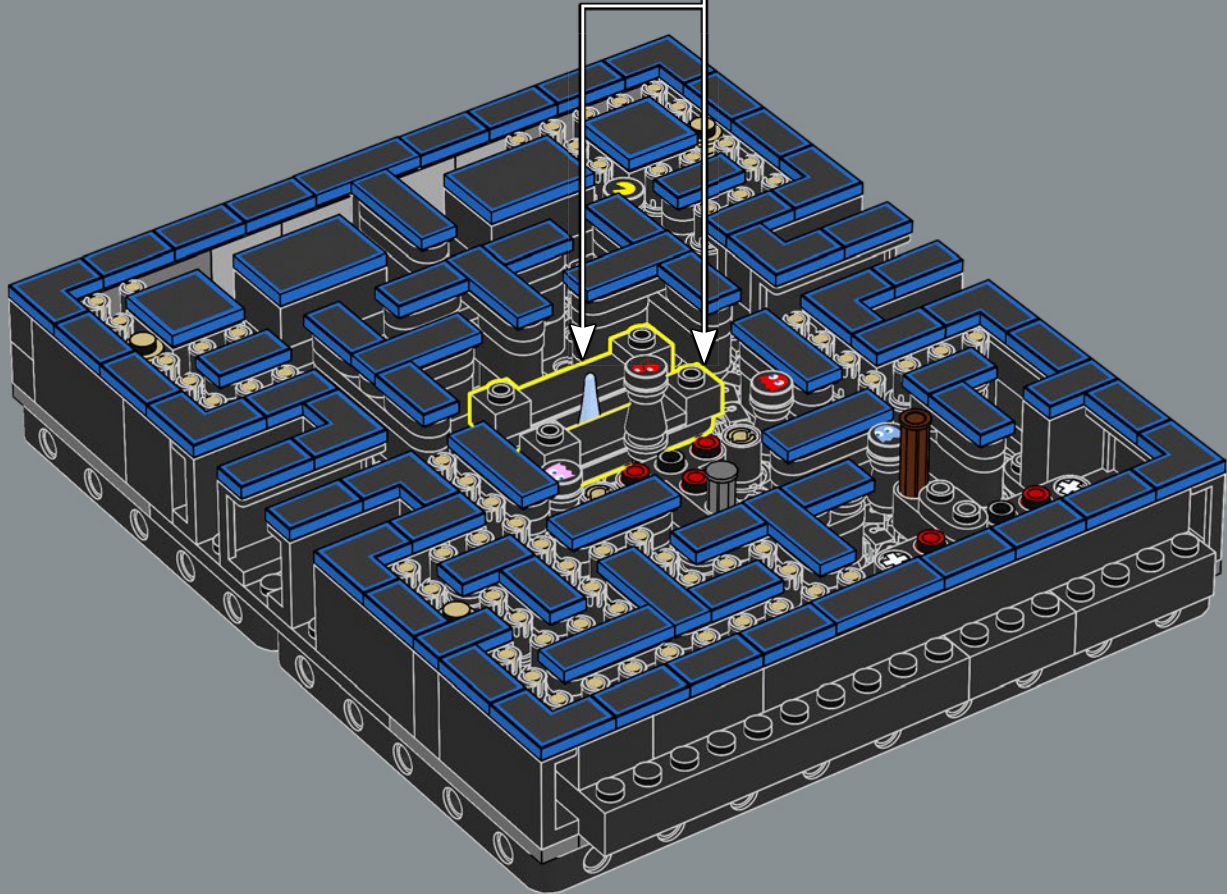
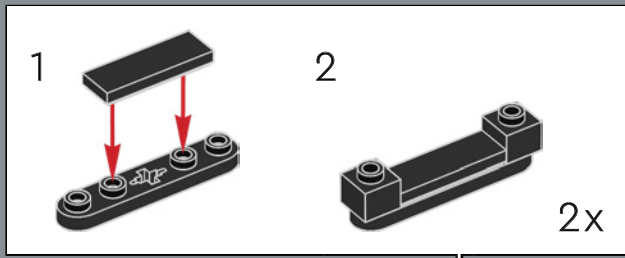

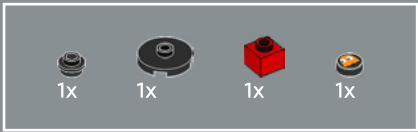

180

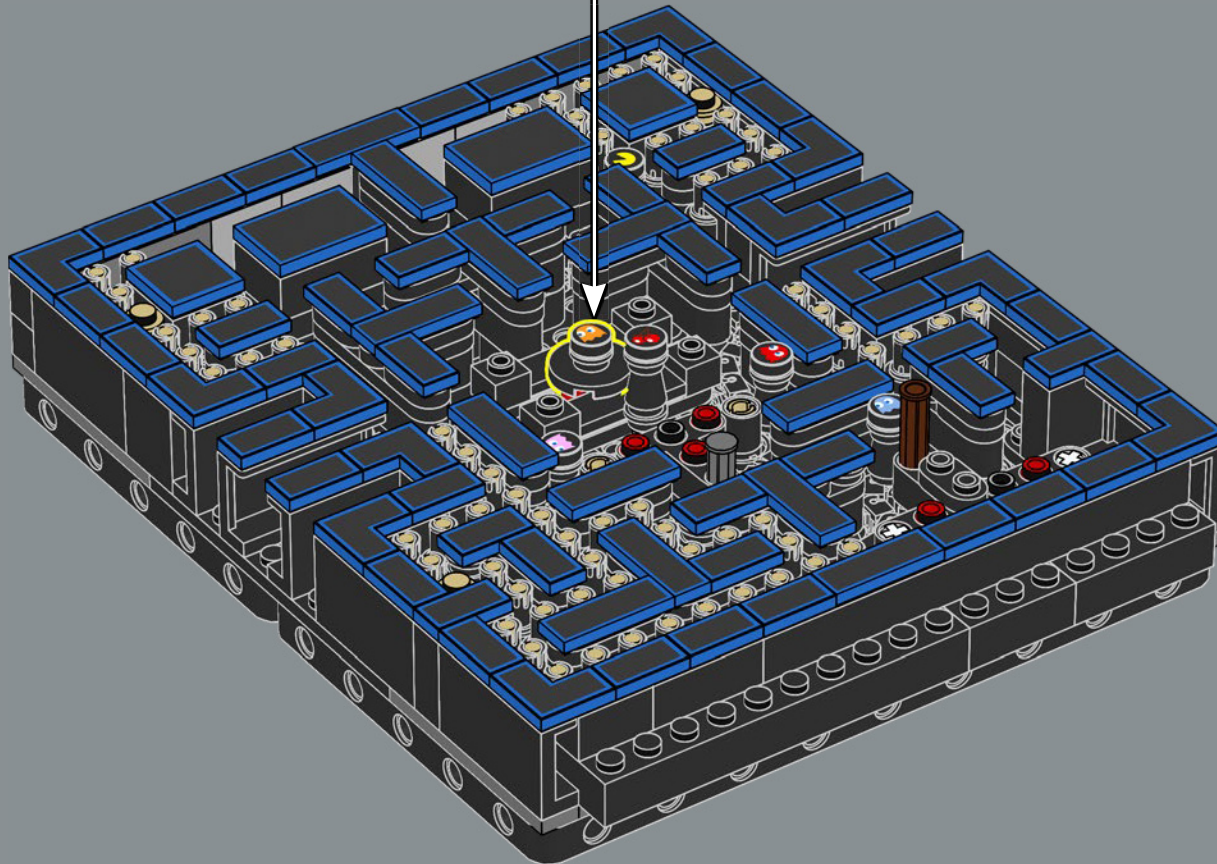
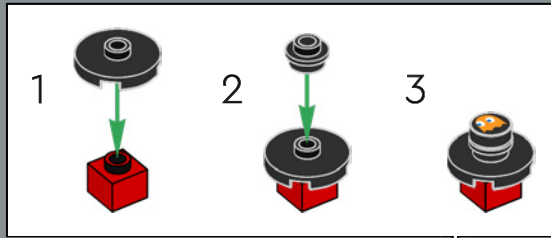

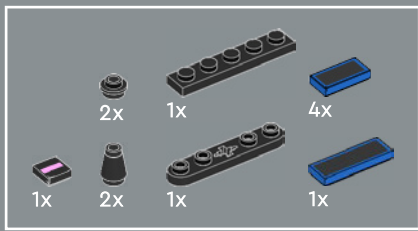

181

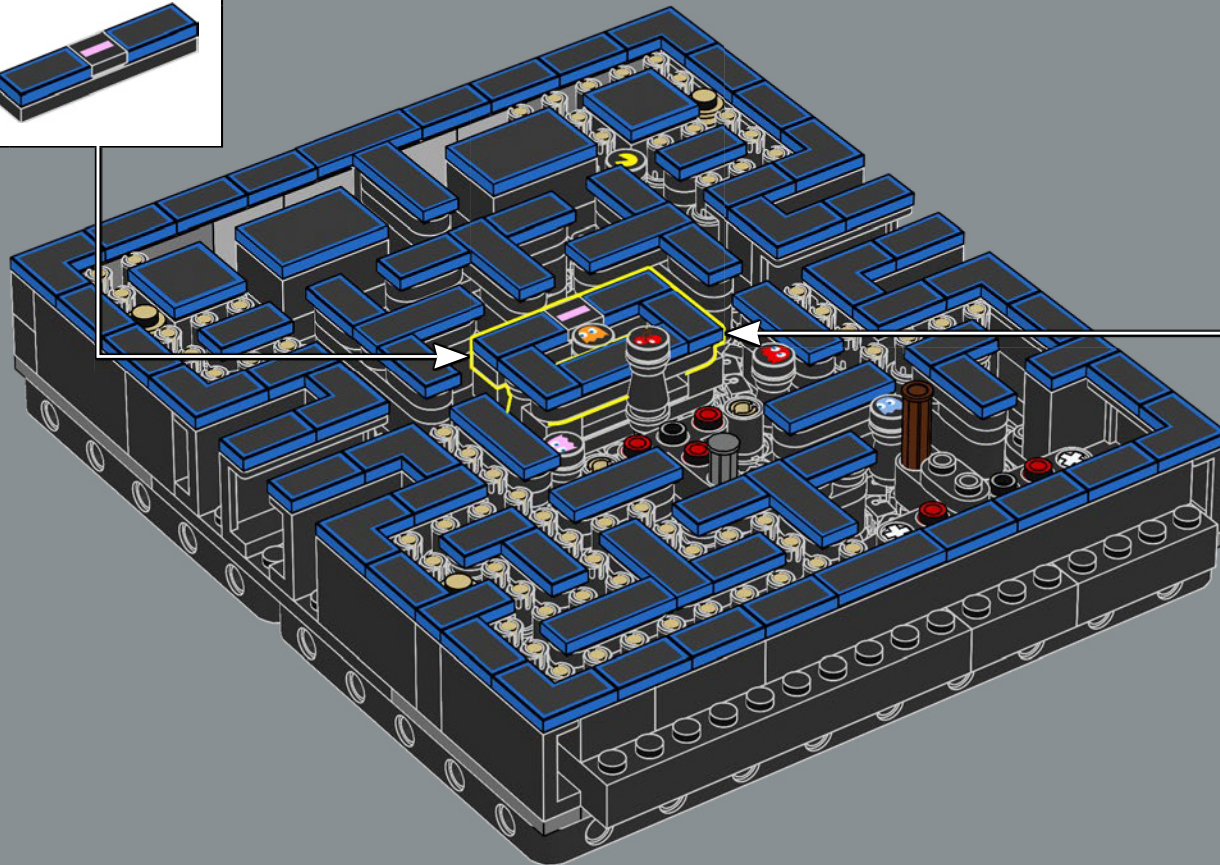
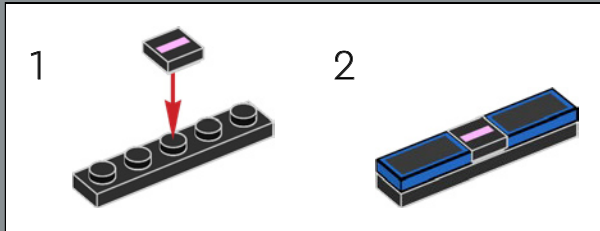
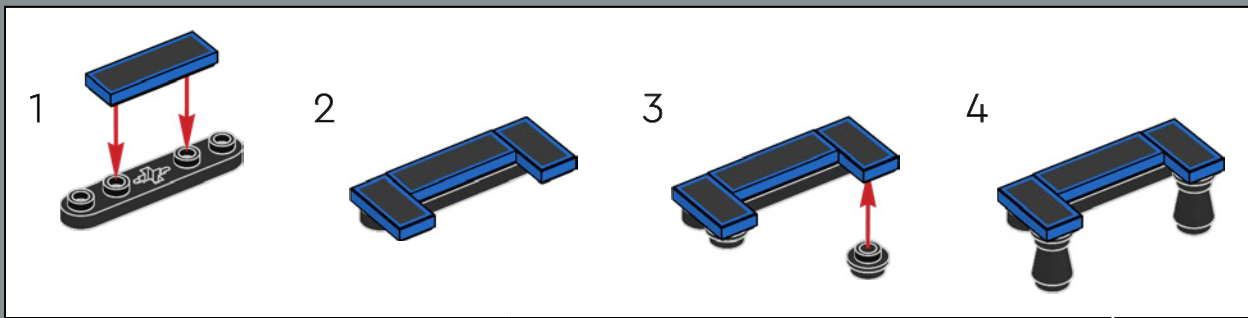



182

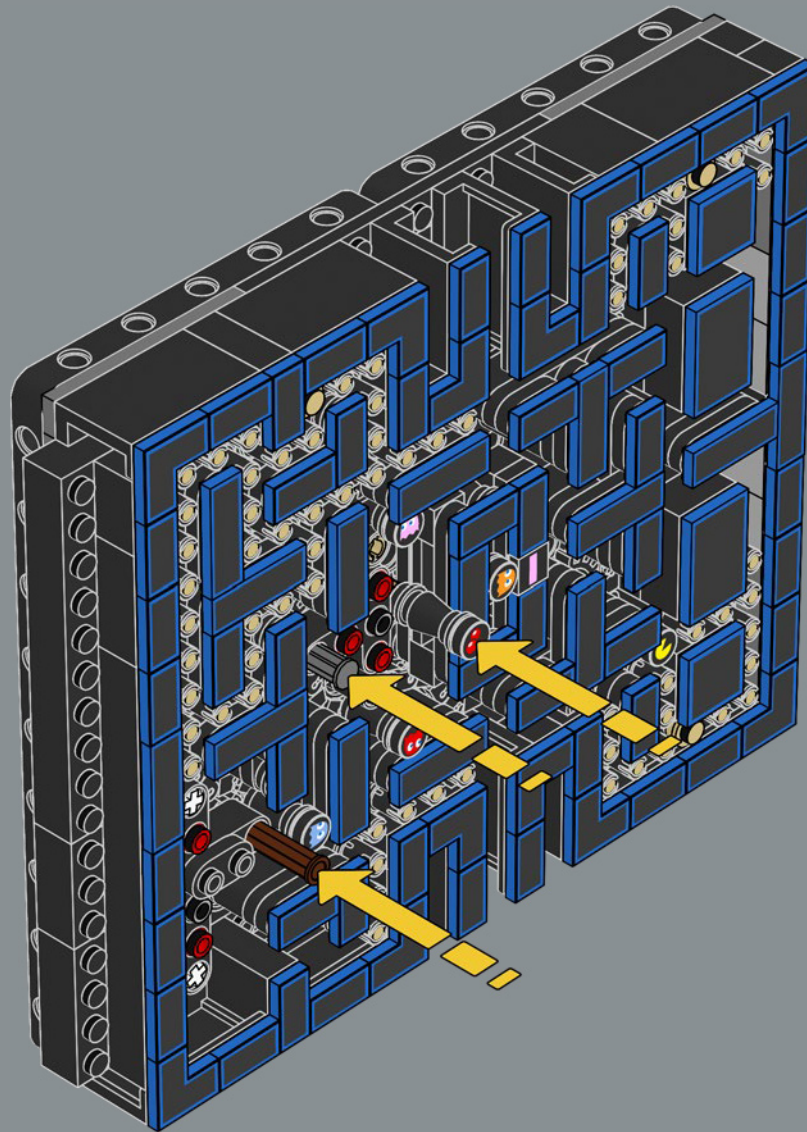

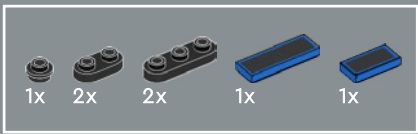

183

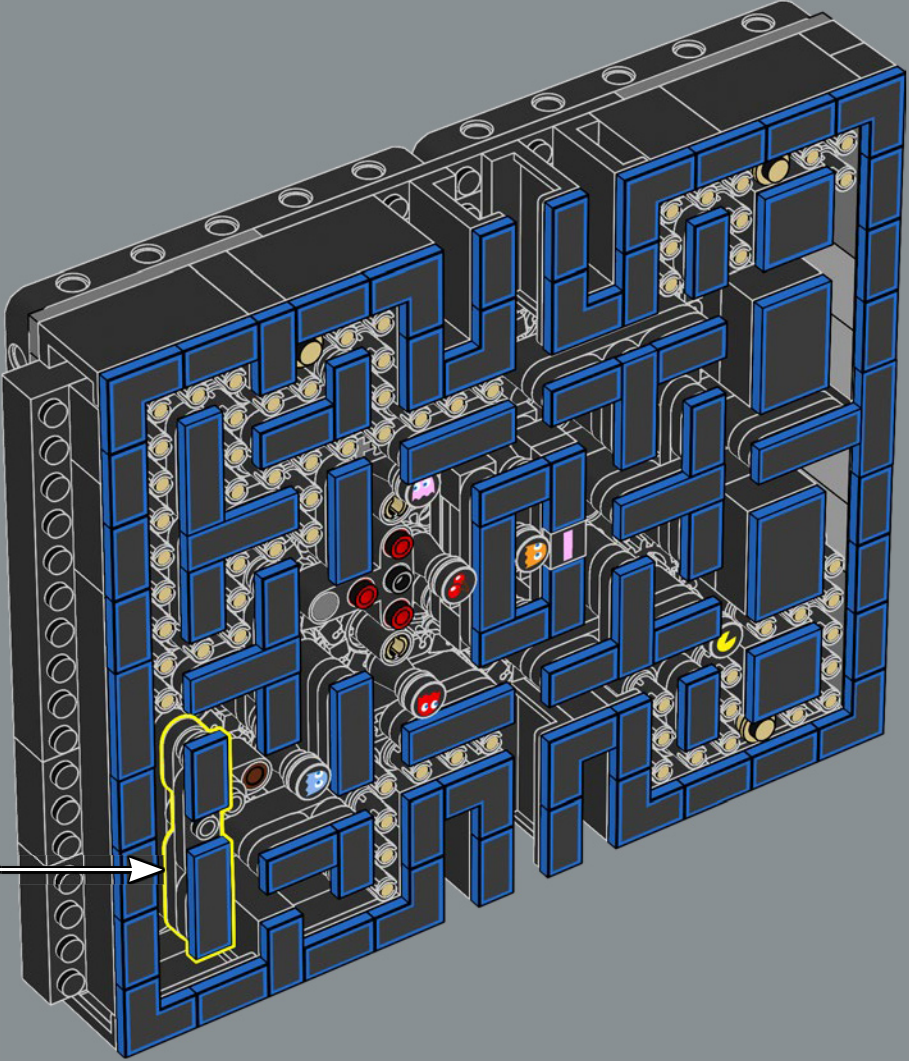
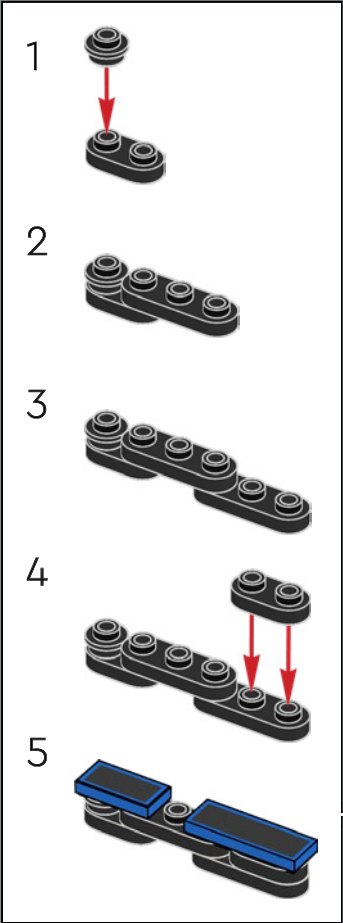

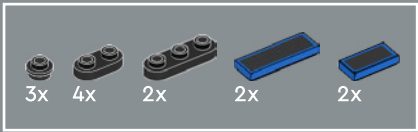

184

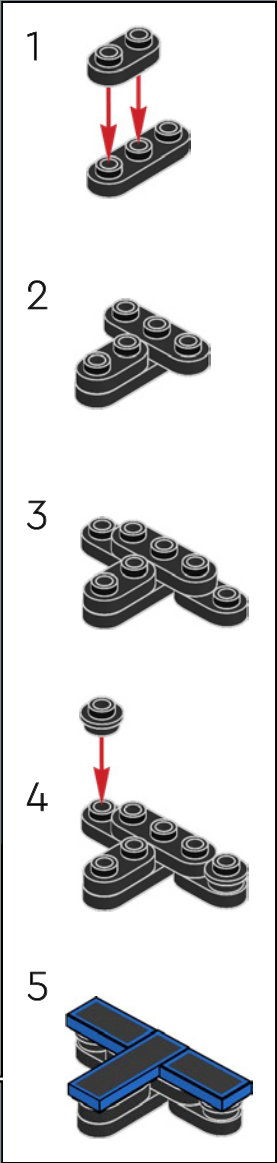
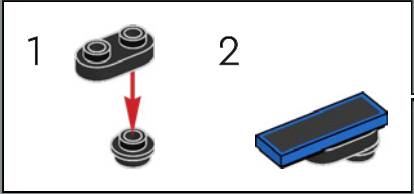
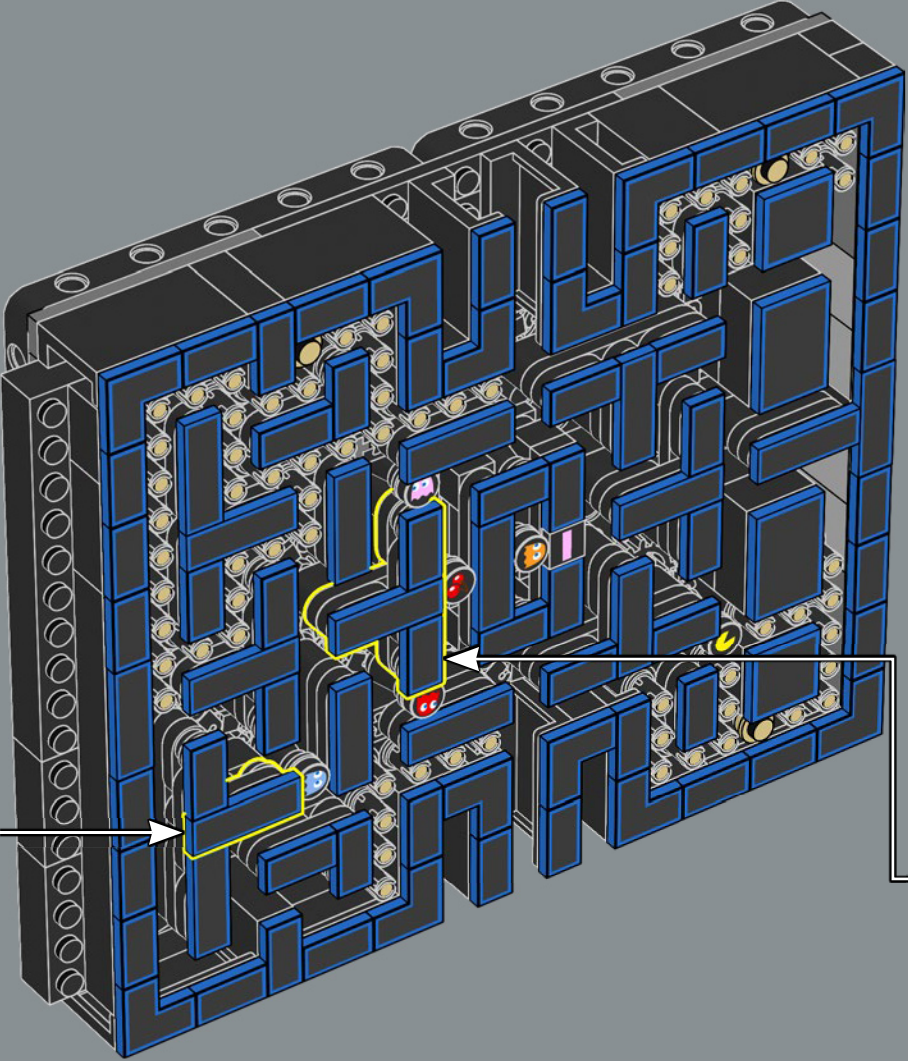

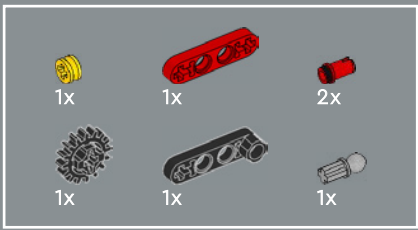

185

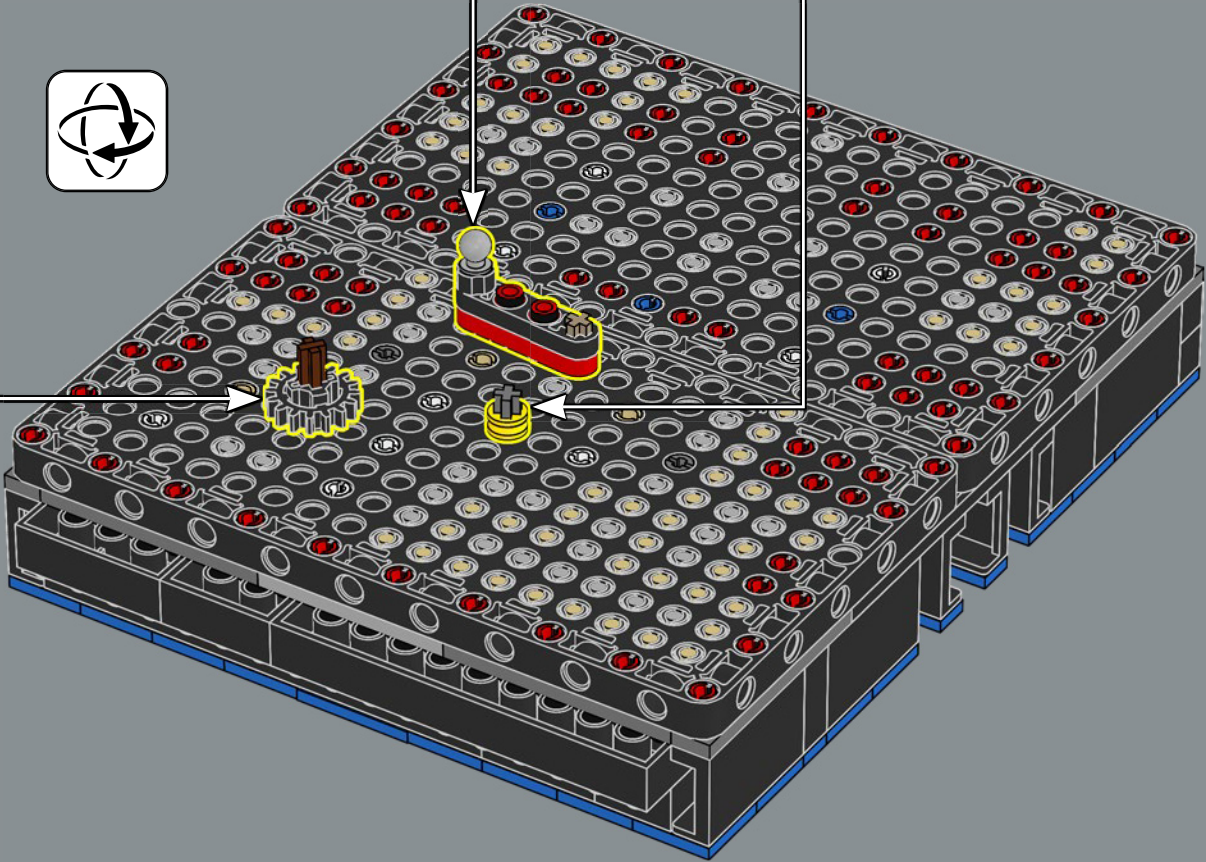
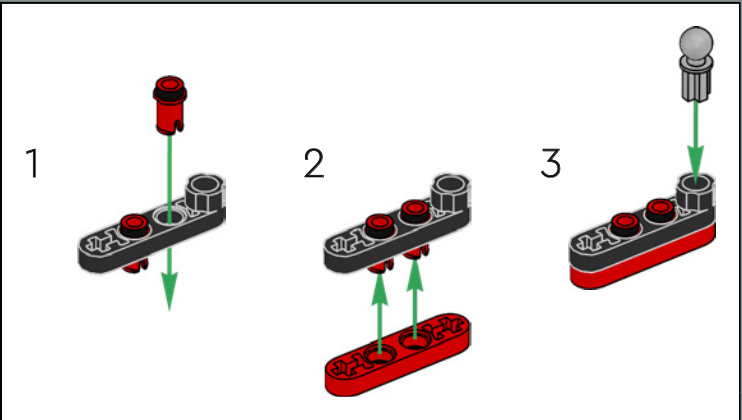

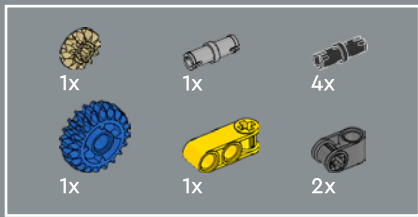

186

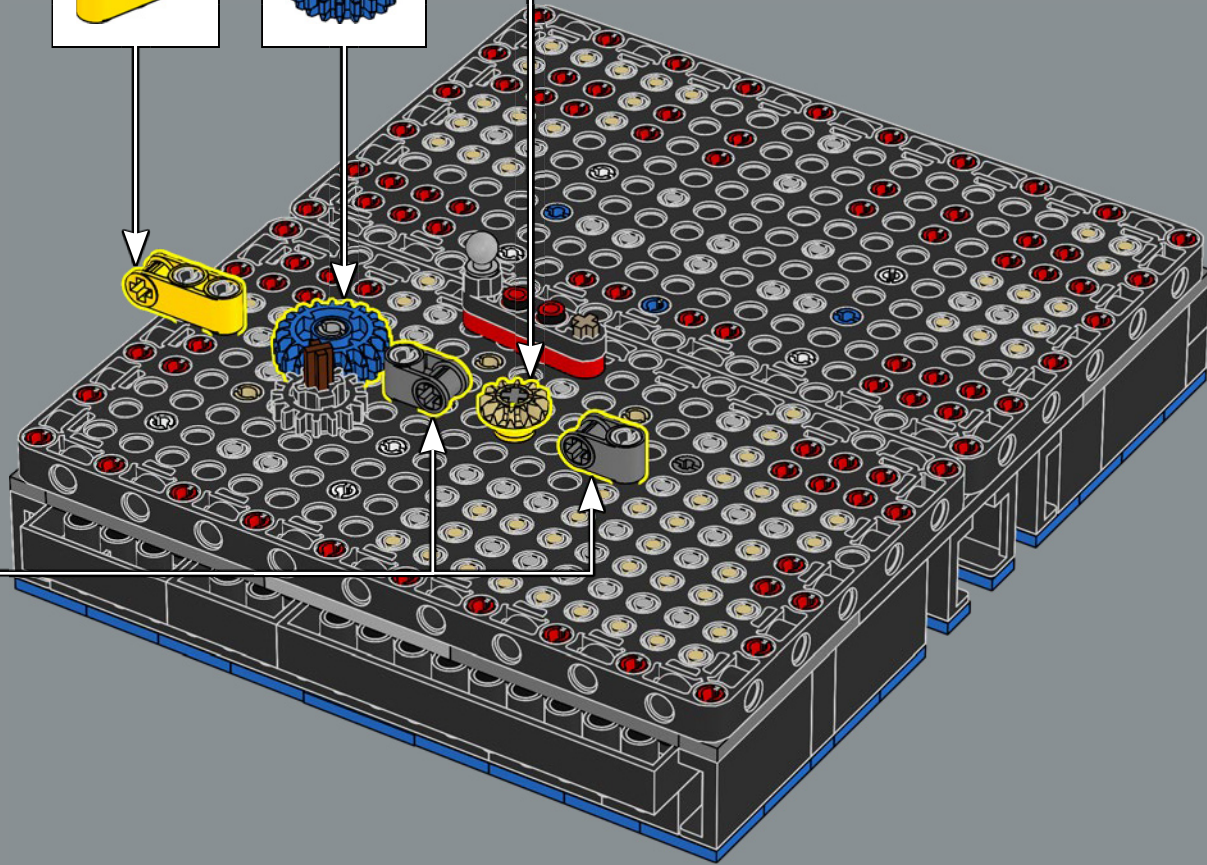
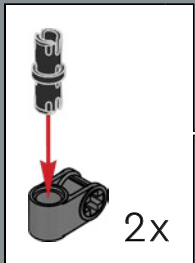
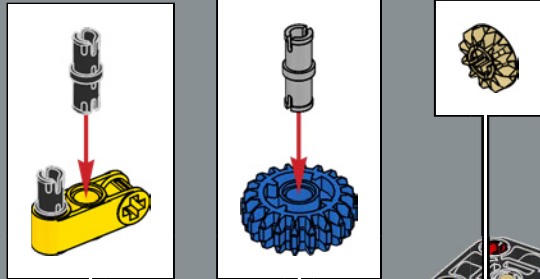

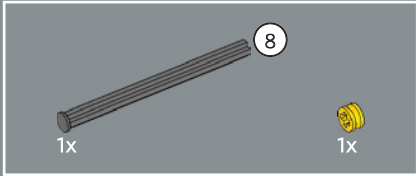
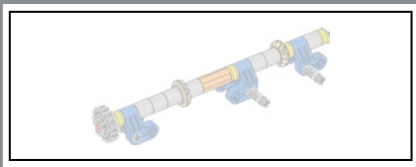

187

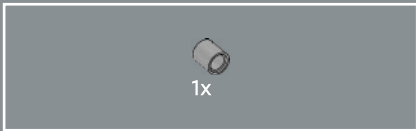
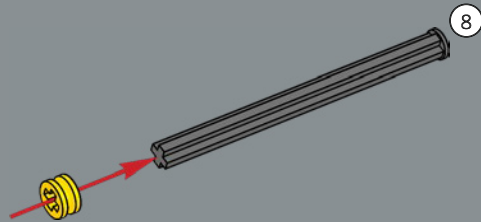

188

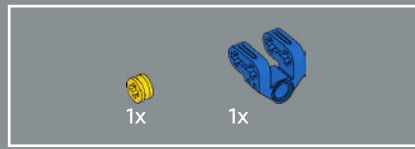
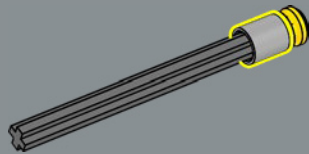

189

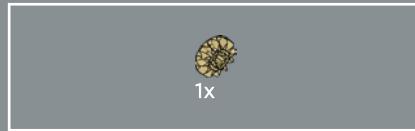
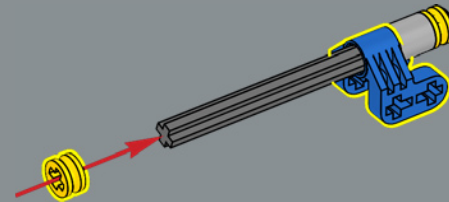

190

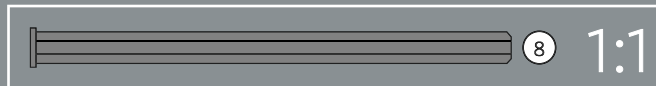
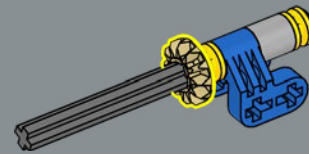



191

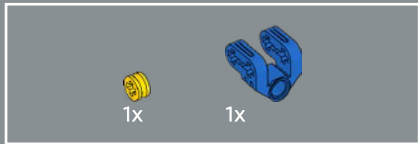
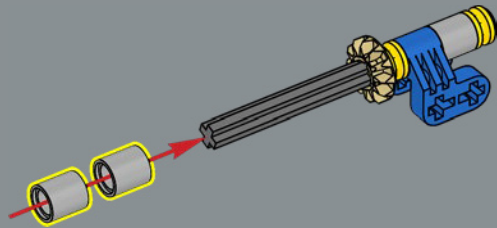

192

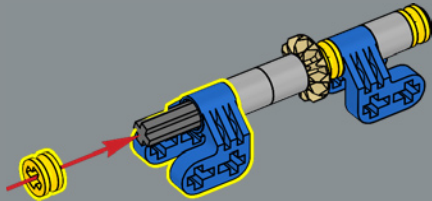

193

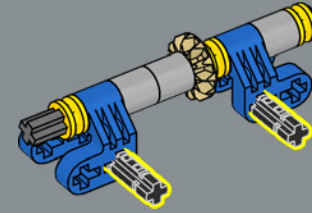

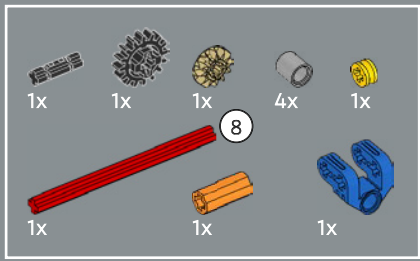

194

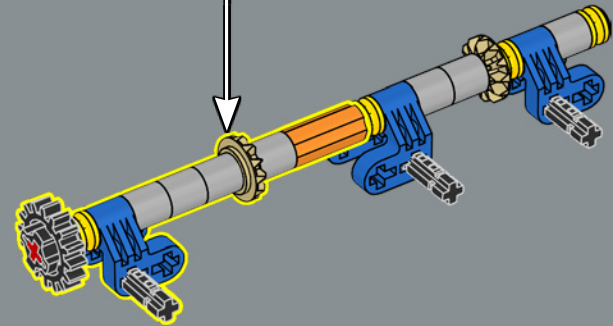
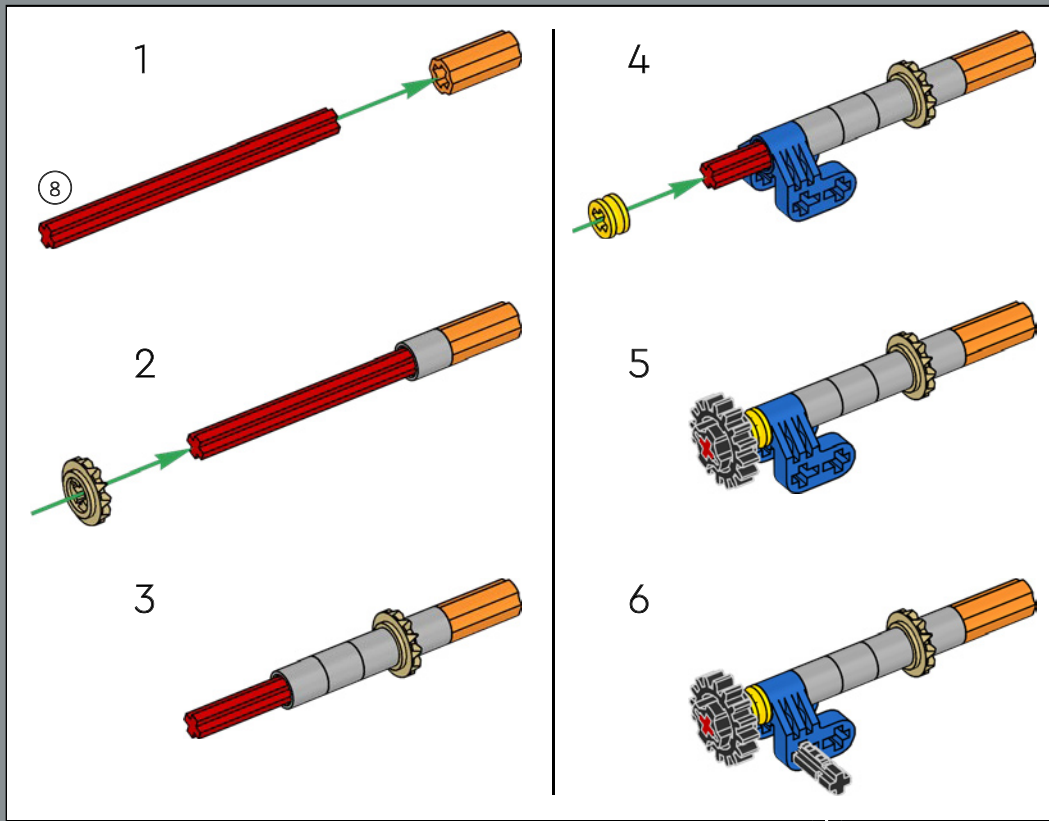



195

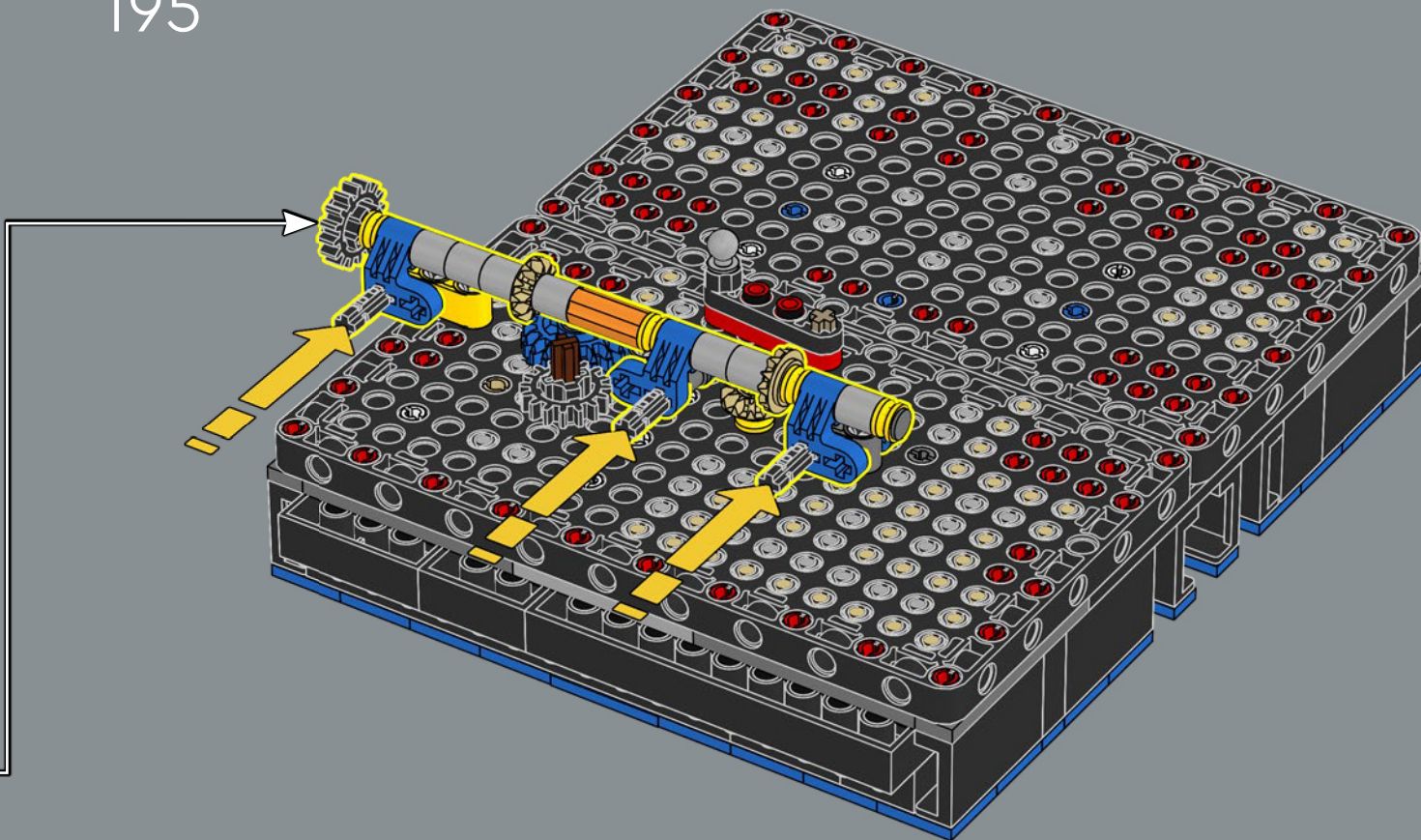



196

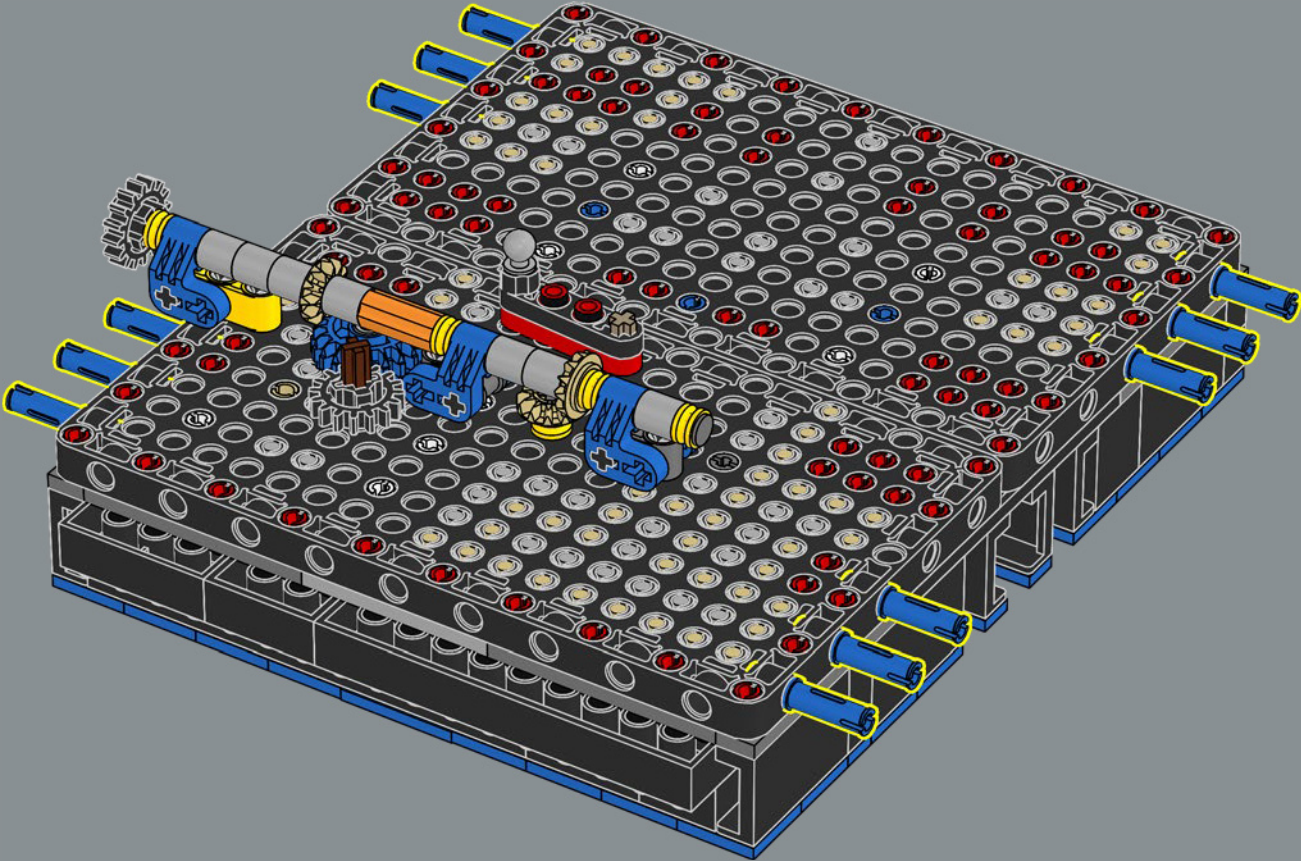

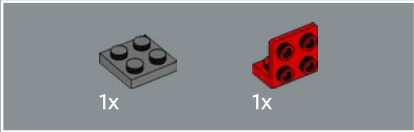
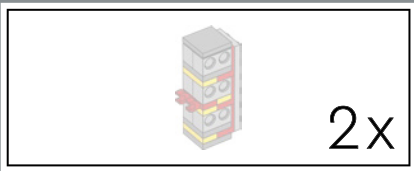

197

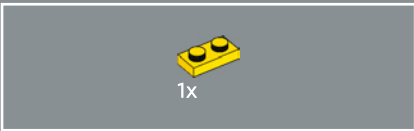
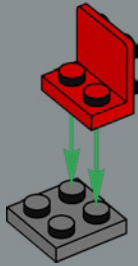

198

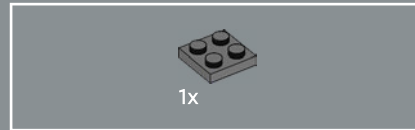

199

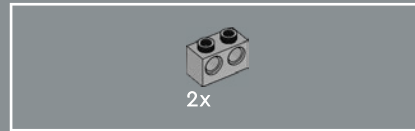
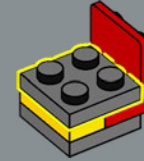

200

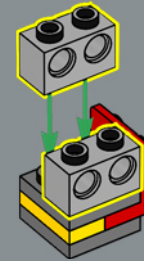

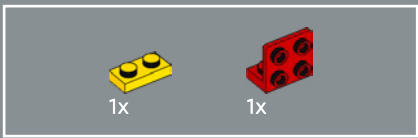

201

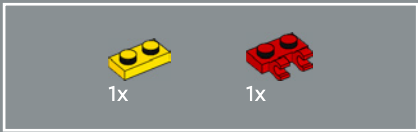
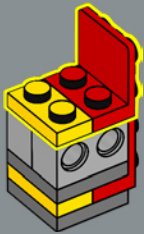

202

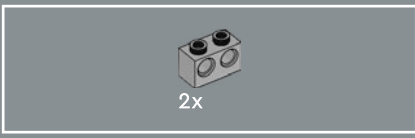
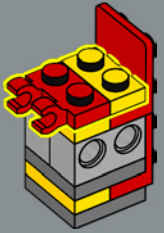

203

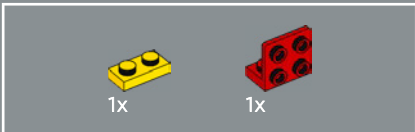
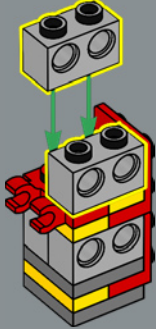

204

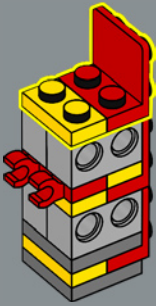

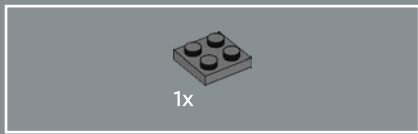

205

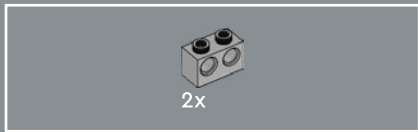
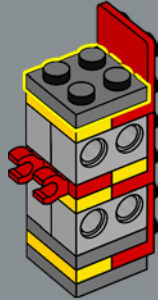

206

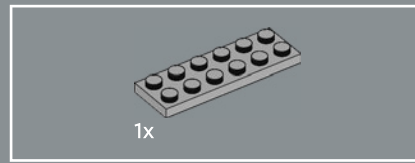
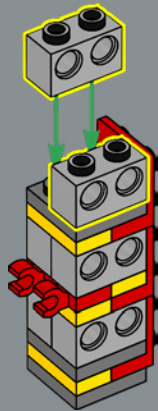

207

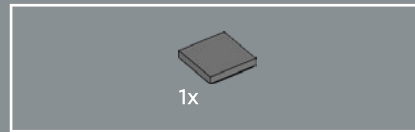
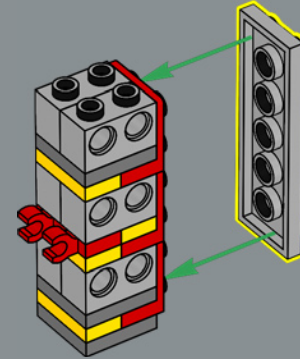

208

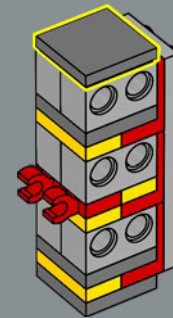

2x



209

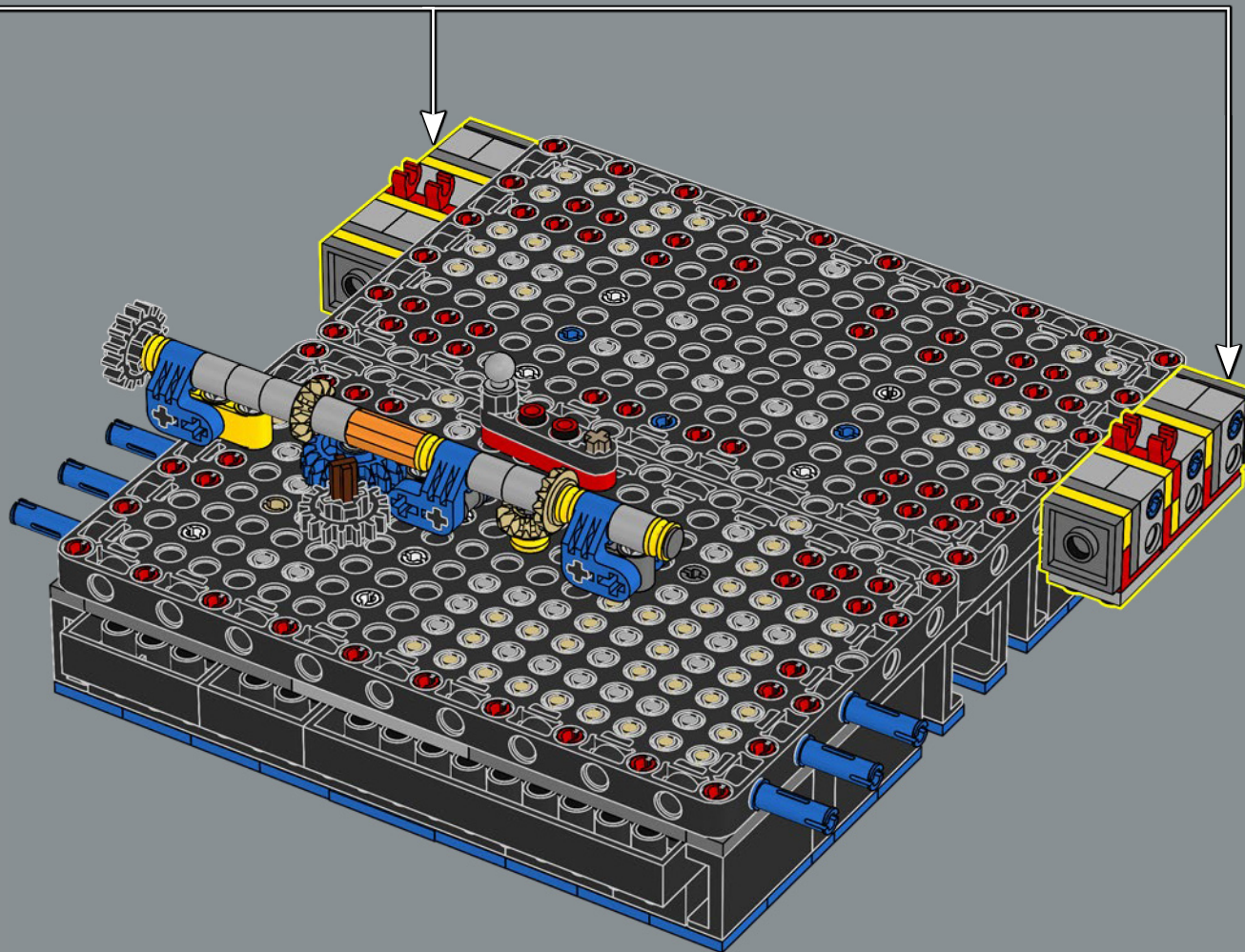

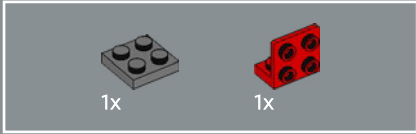
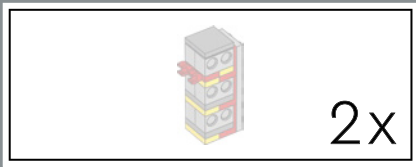

210

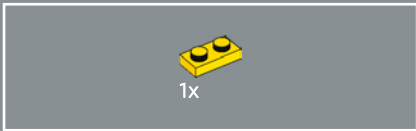
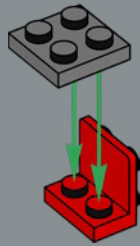

211

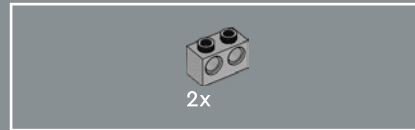
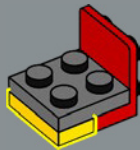

212

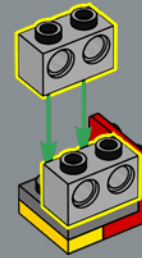

213

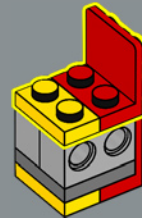

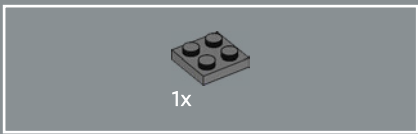

214

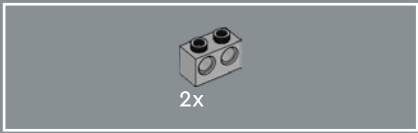

215

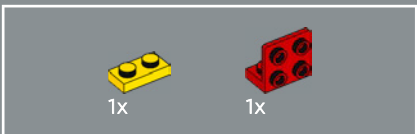
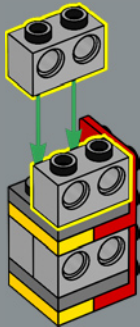

216

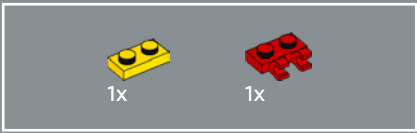
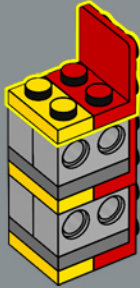

217

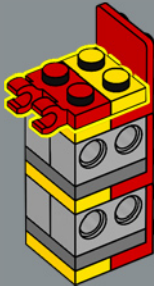



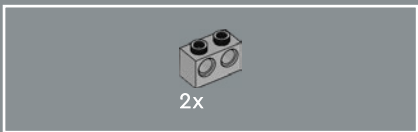

218

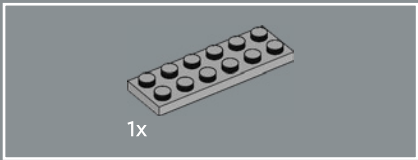
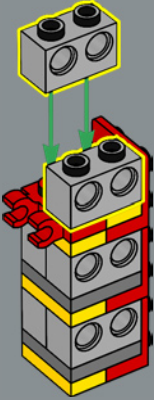

219

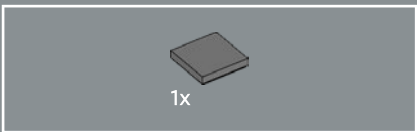
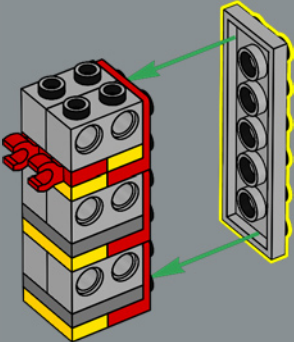

220

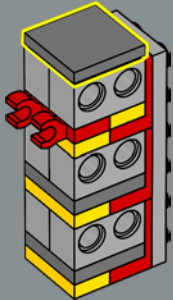

2x



221

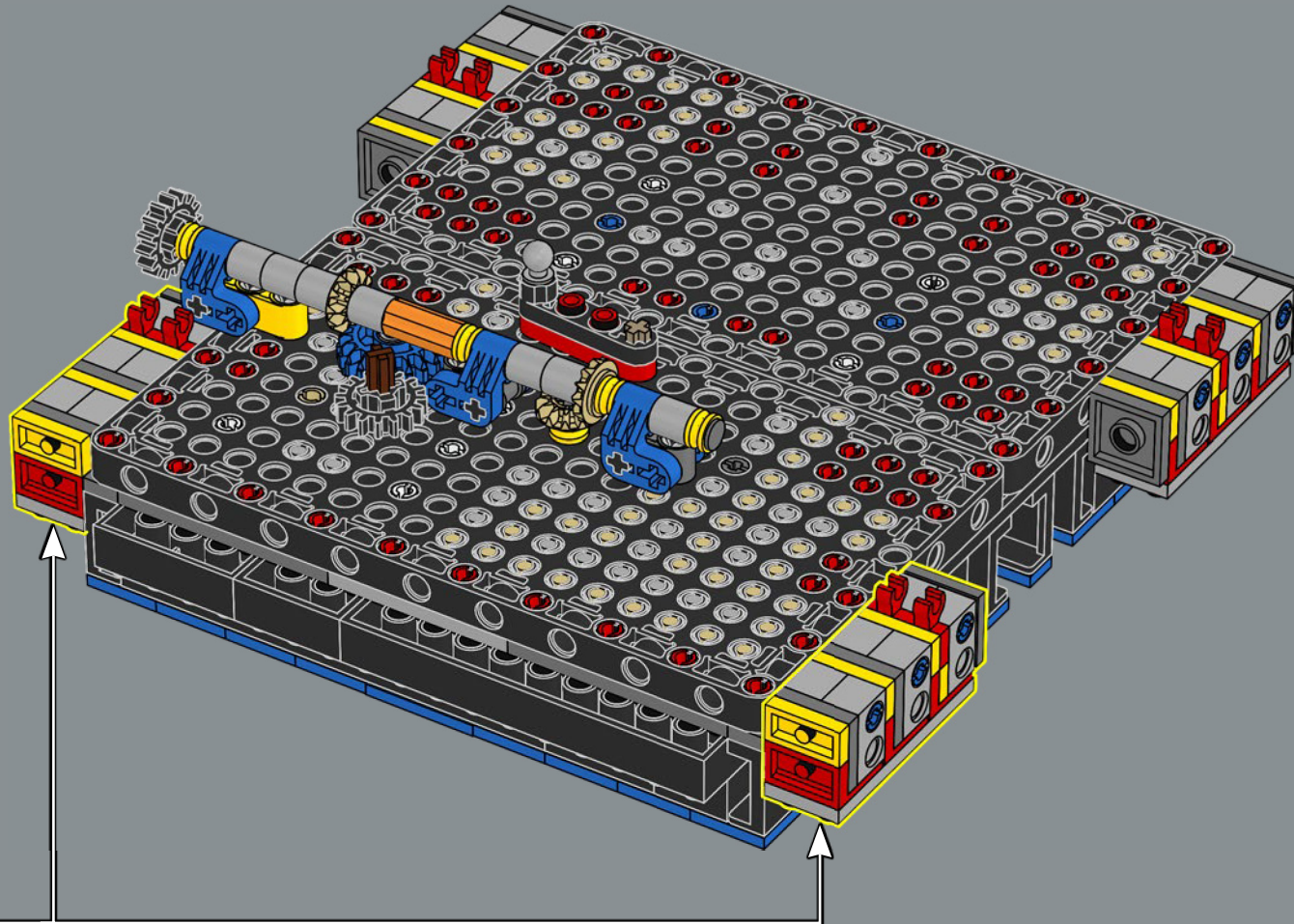

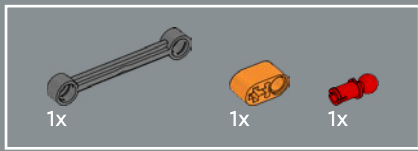

222

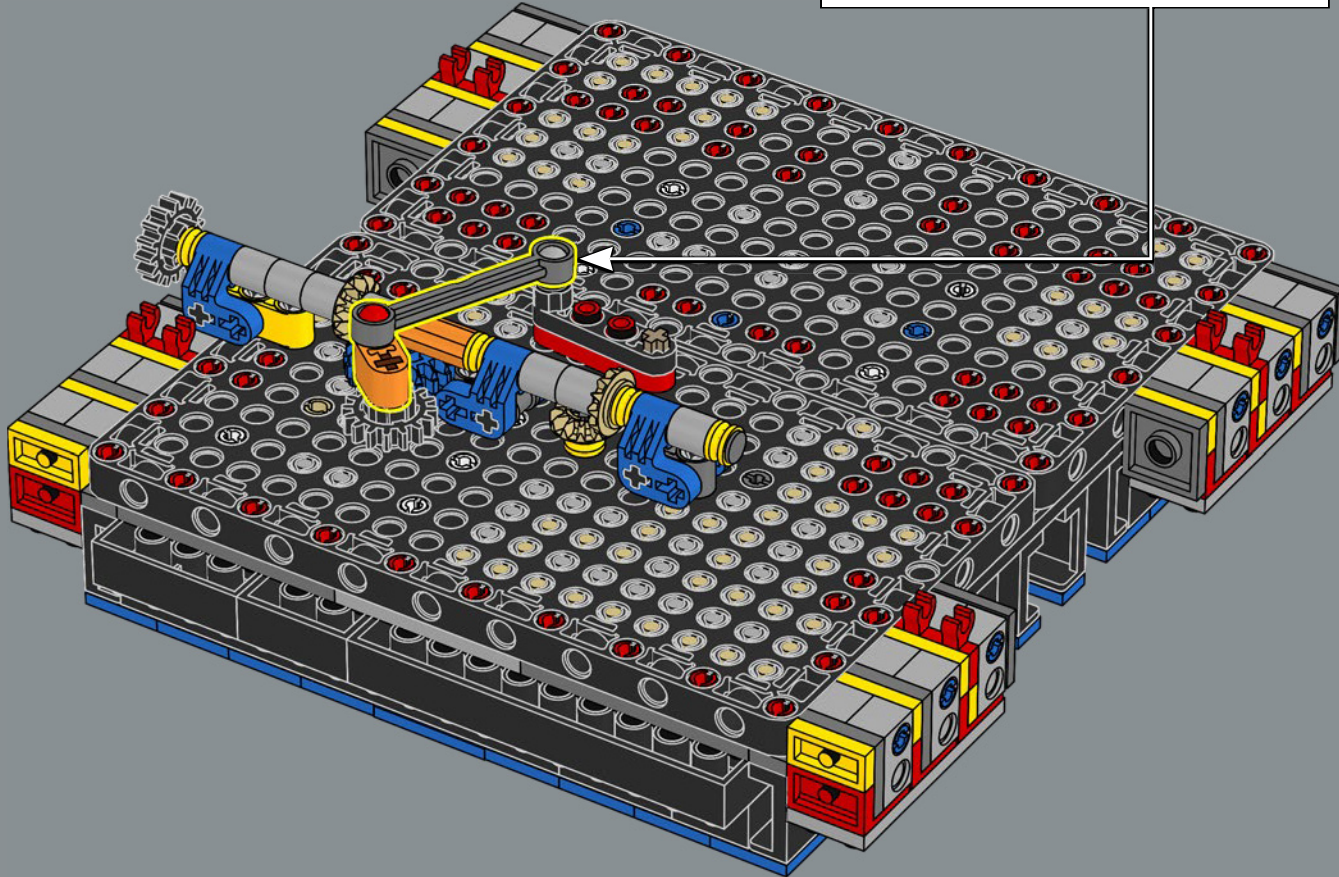
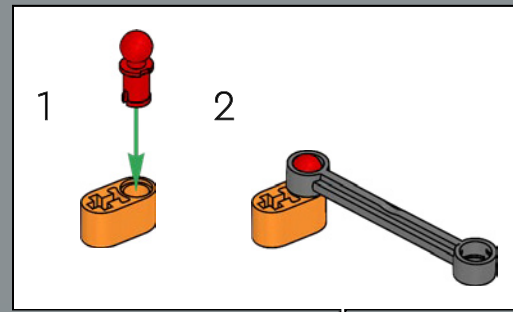

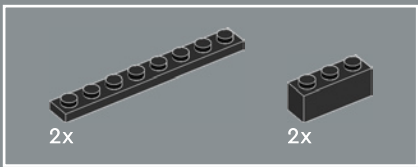

223

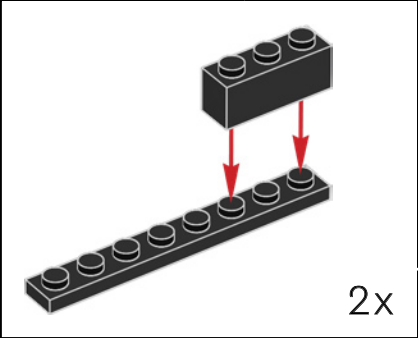
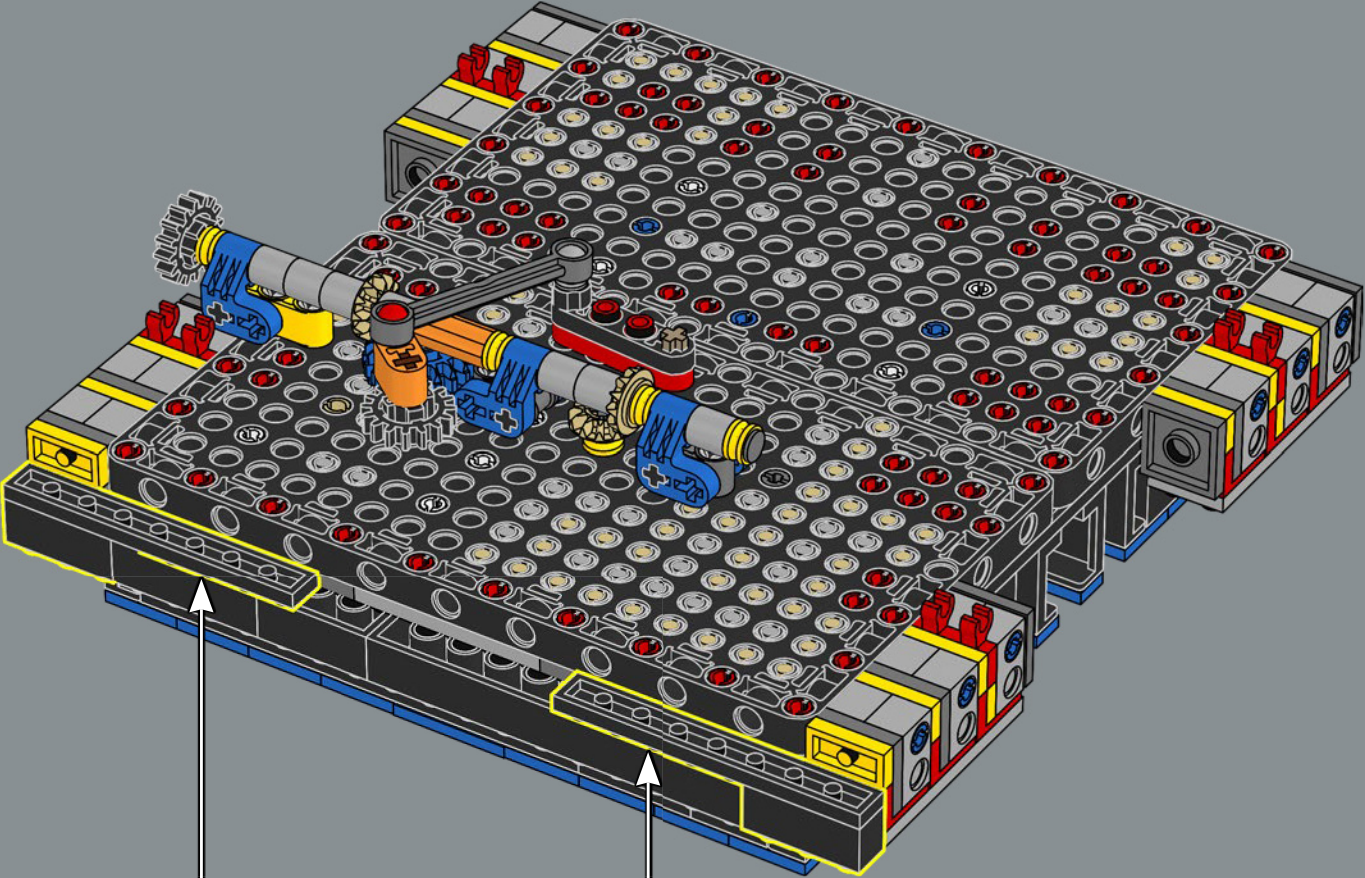

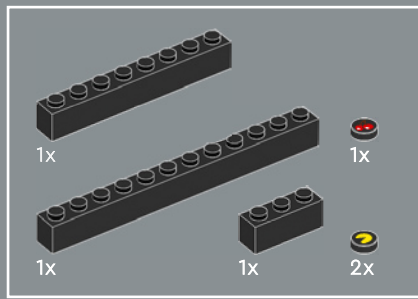

224

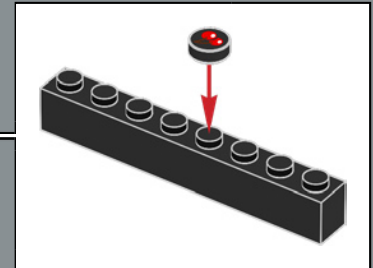
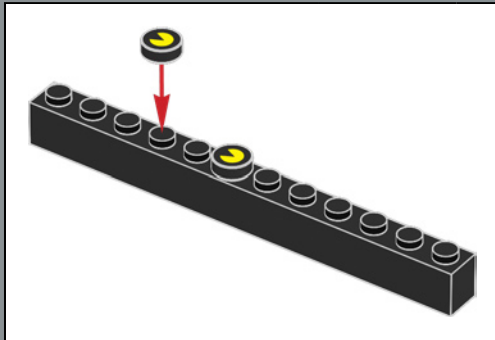
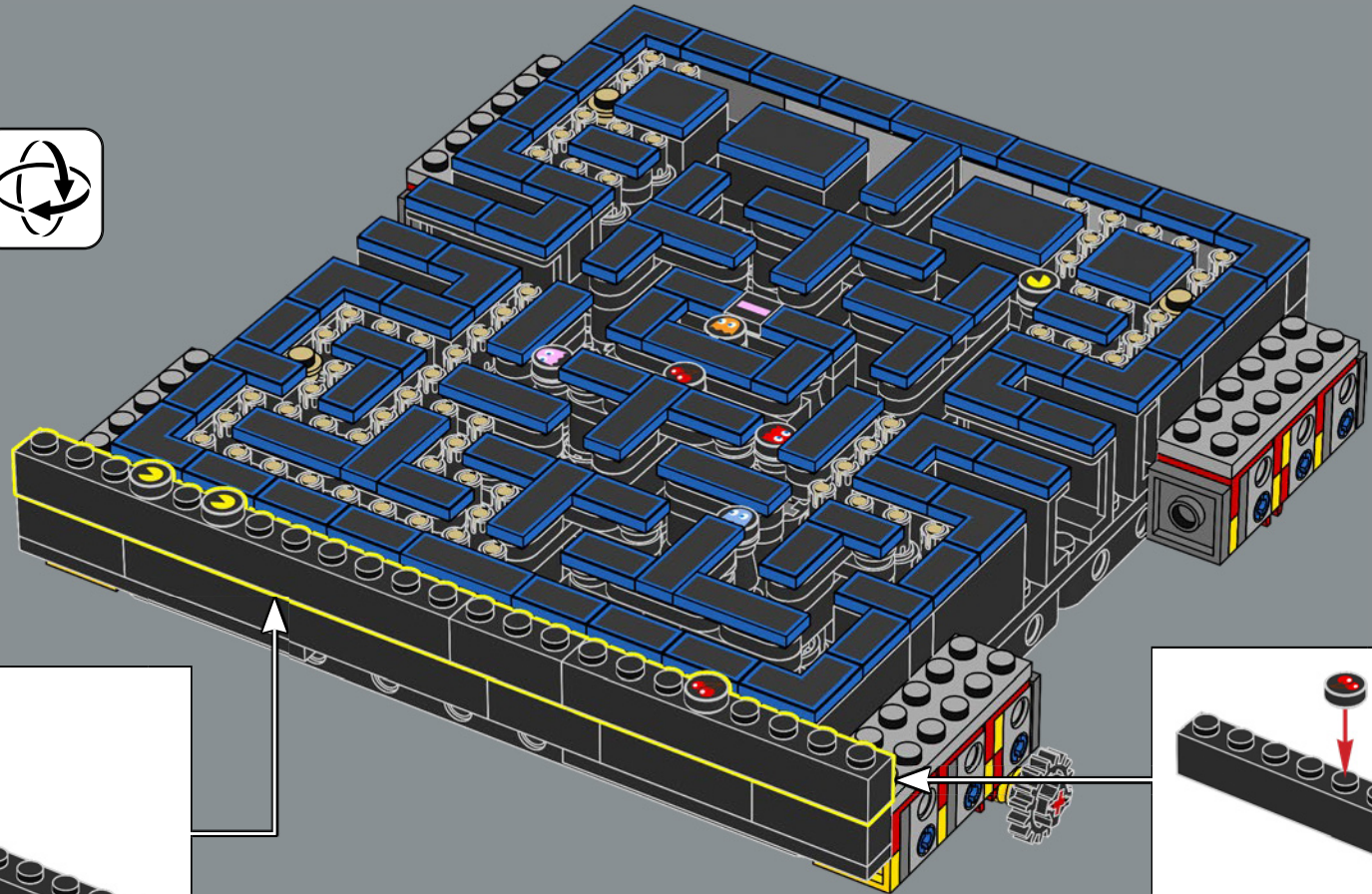

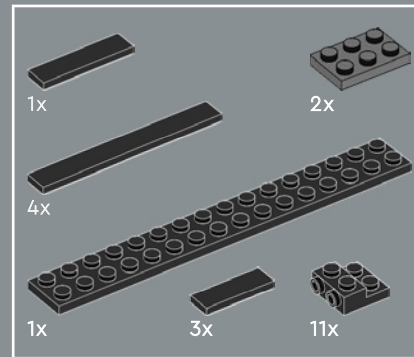
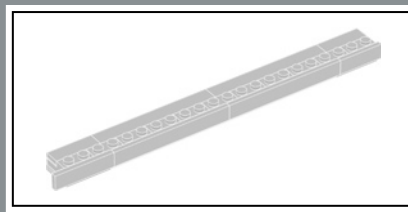

225

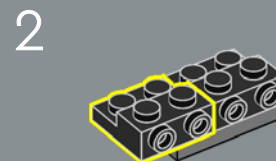
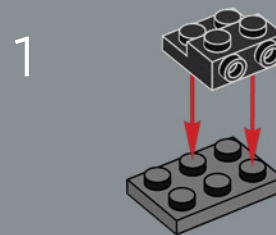

3

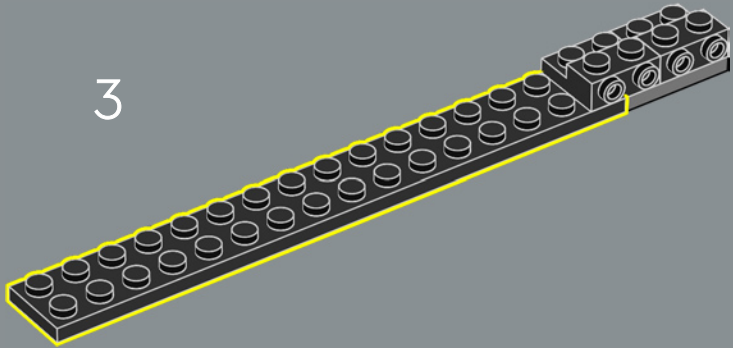

4

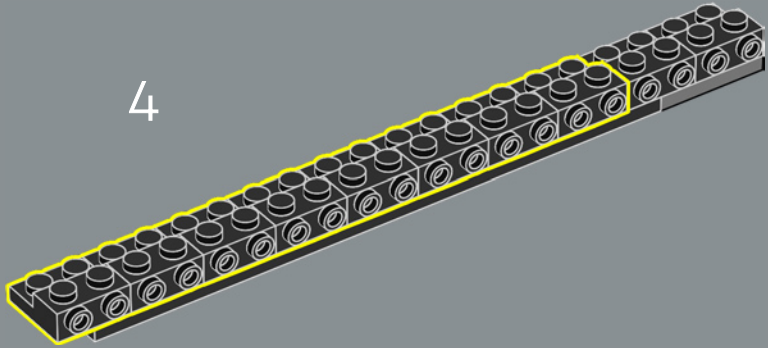

5

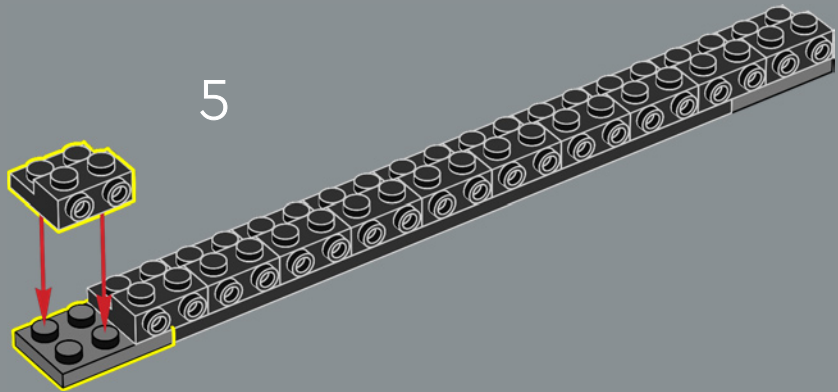

6

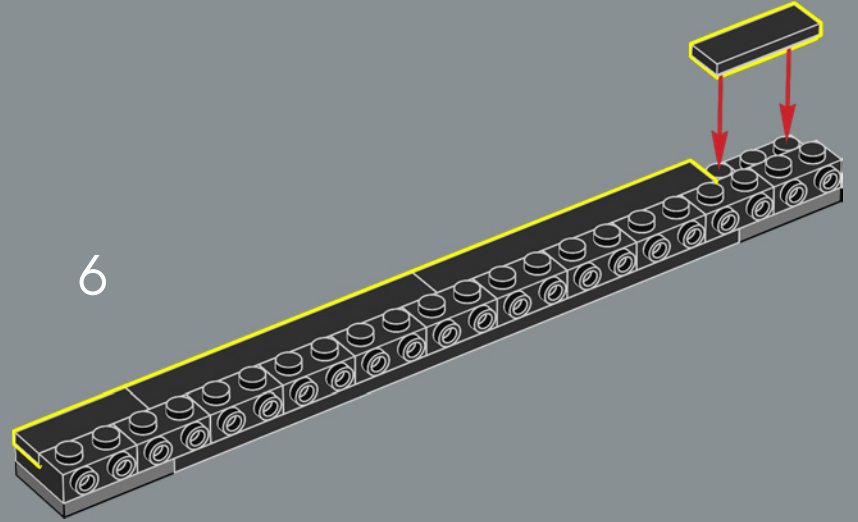

7

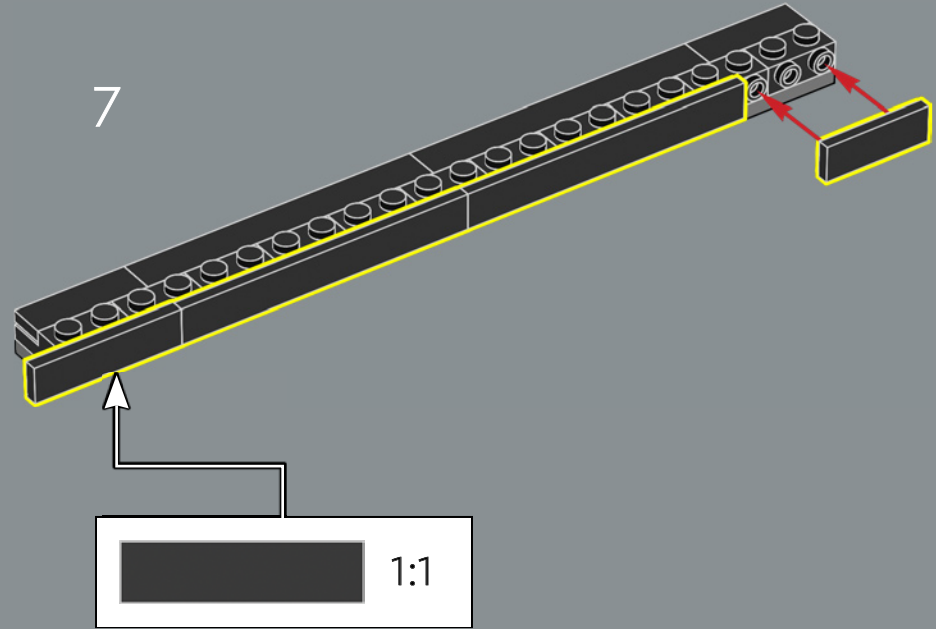

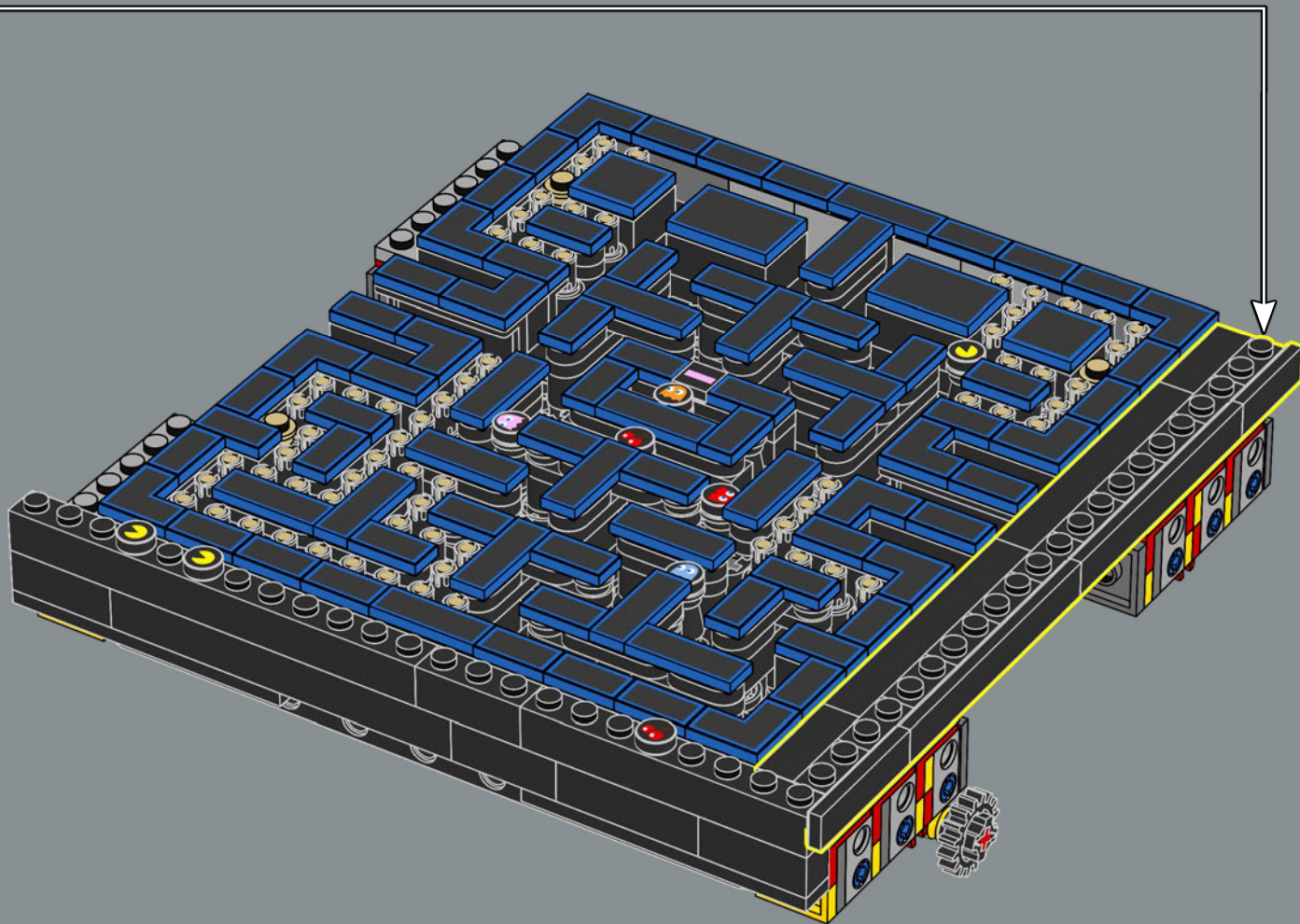



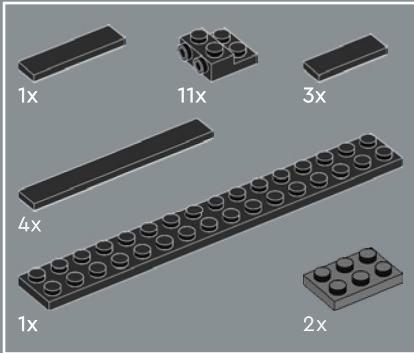
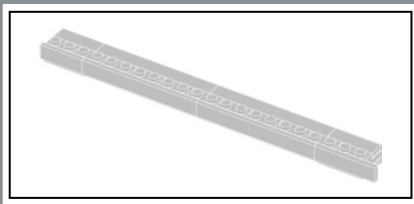

226

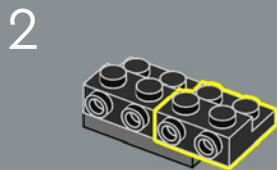
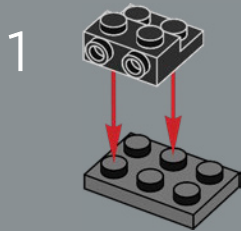

3

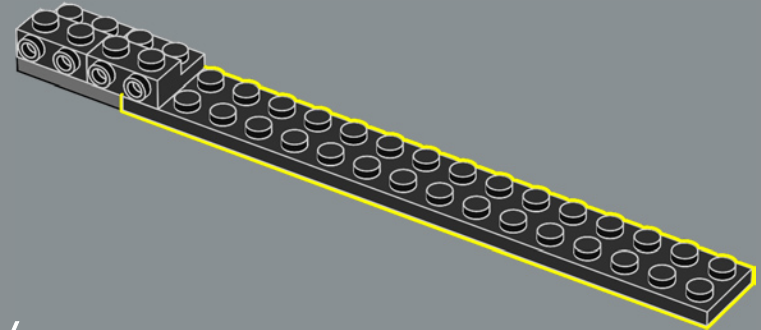

4

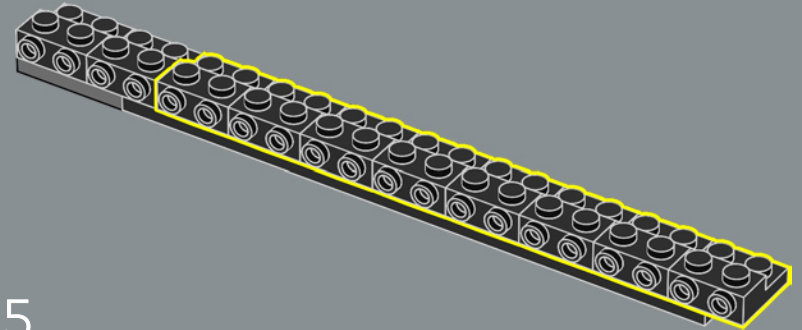

5

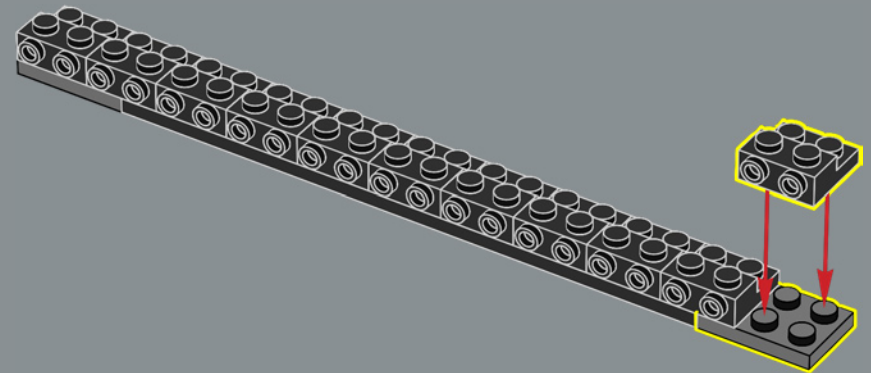

6

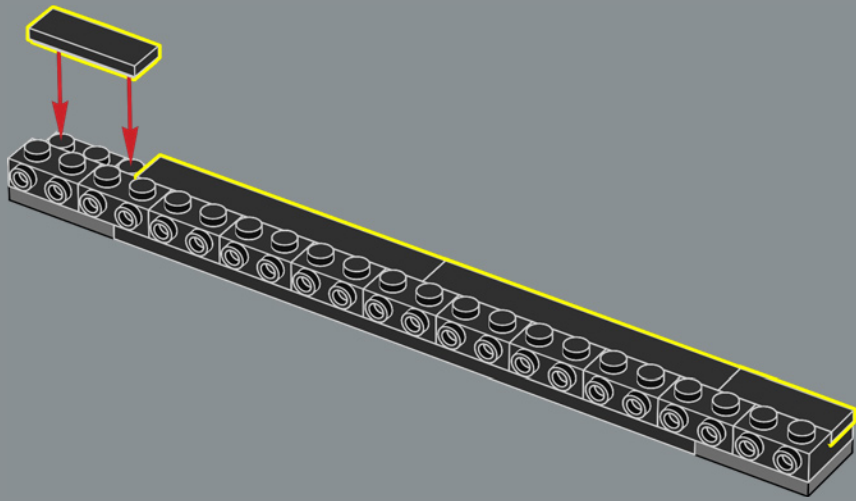

7

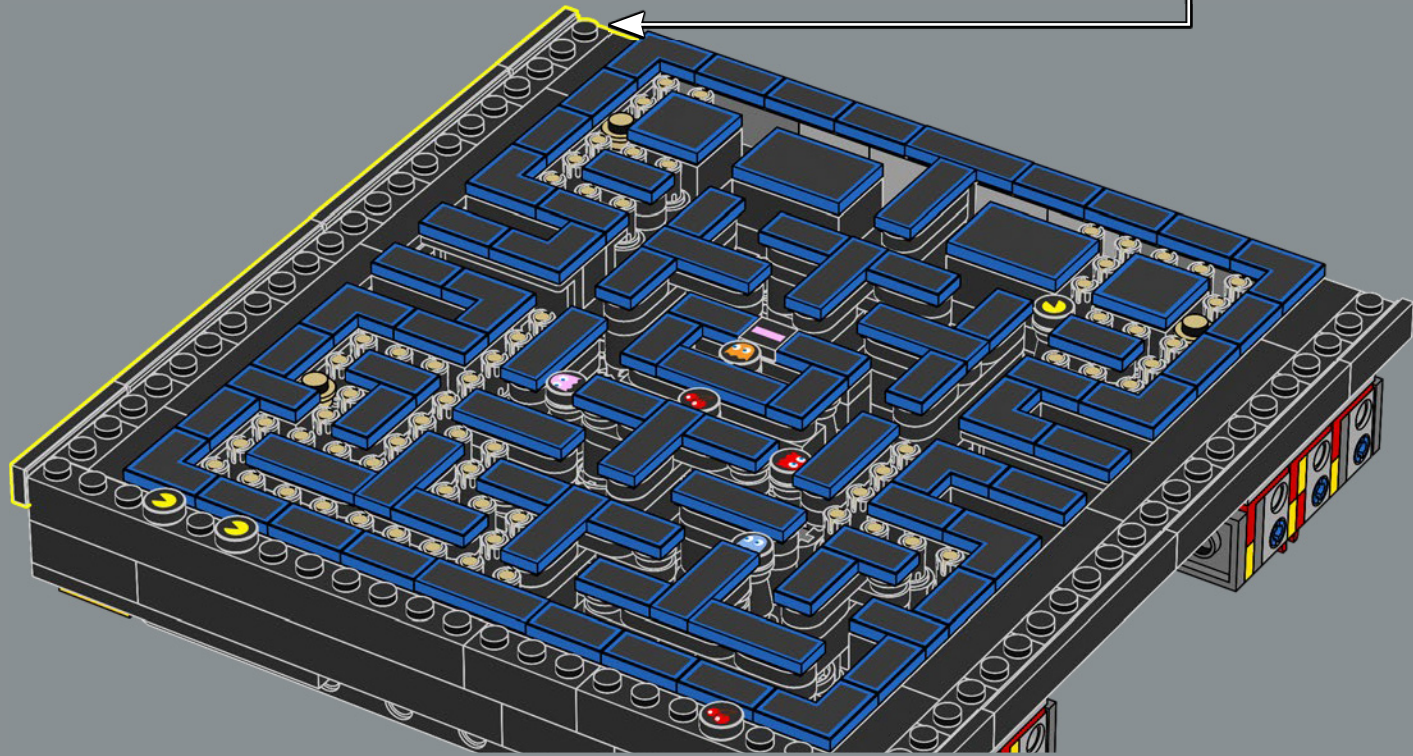
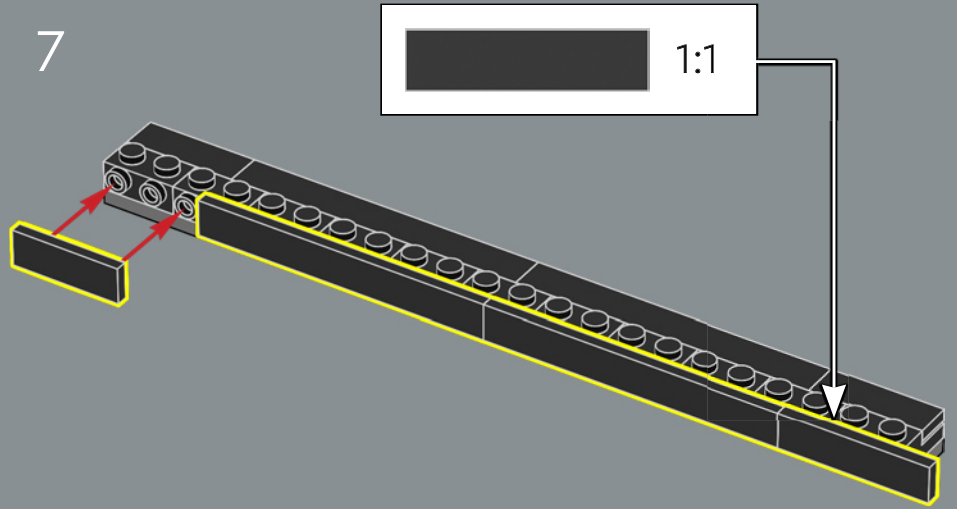

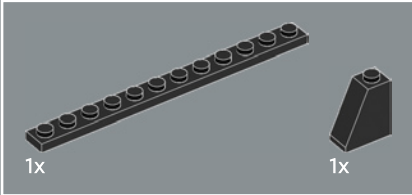
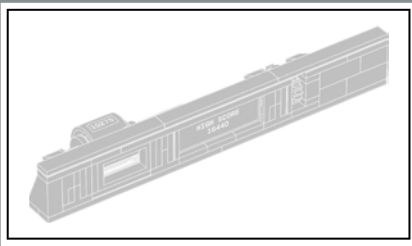

227

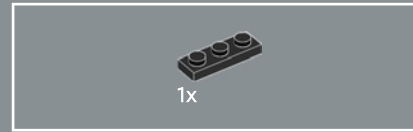
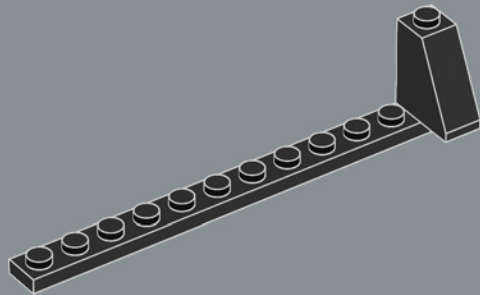

228

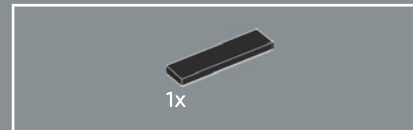
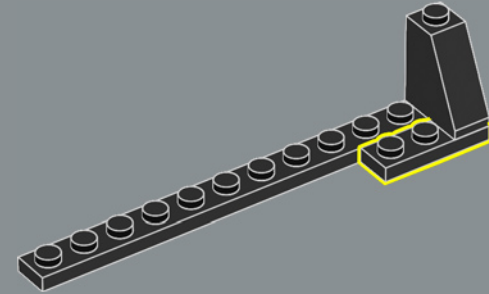

229

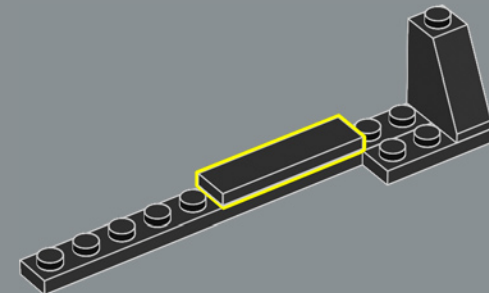

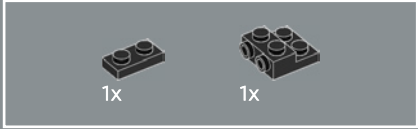
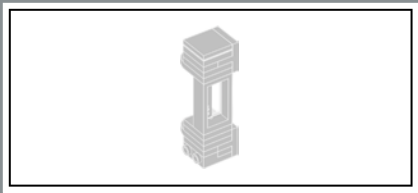

230

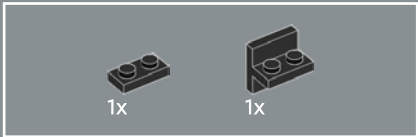
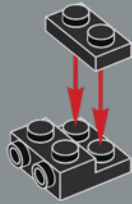

231

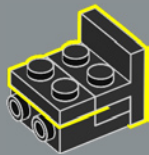

232

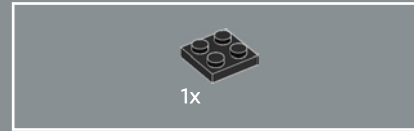
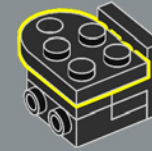

233

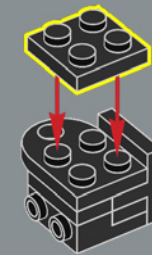

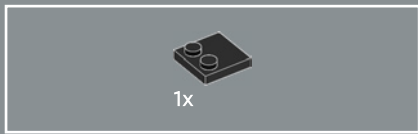

234

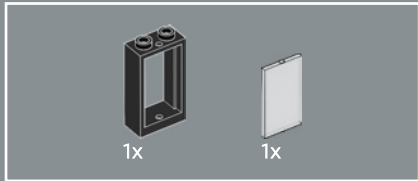
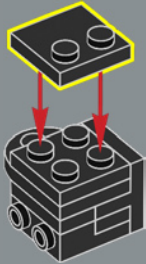

235

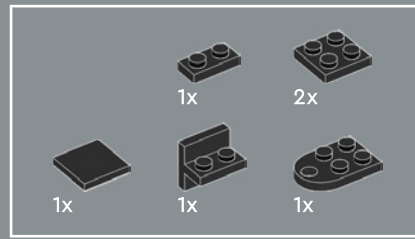
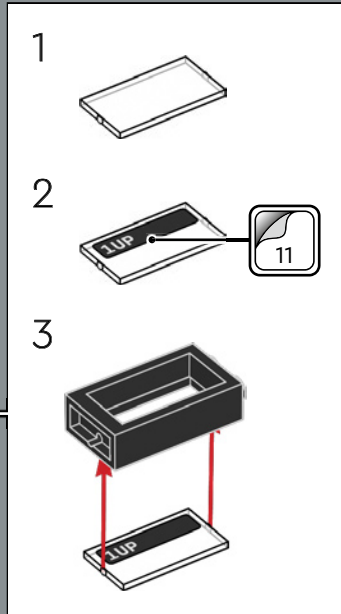
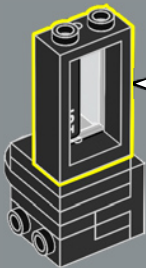

236

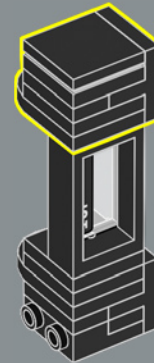
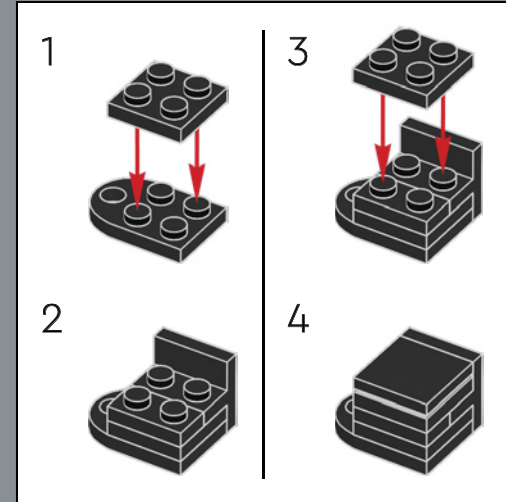

237

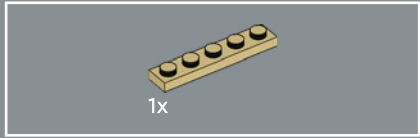
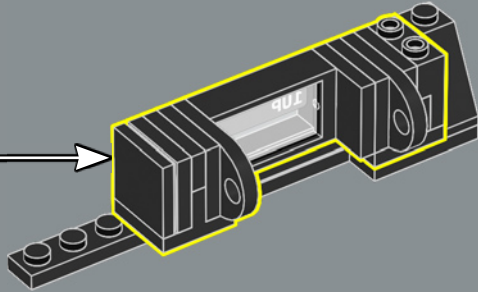

238

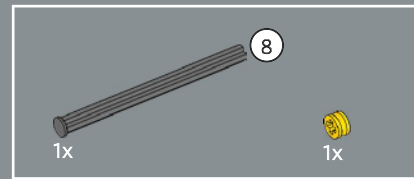
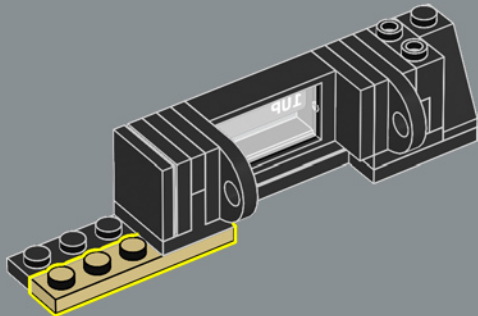

239

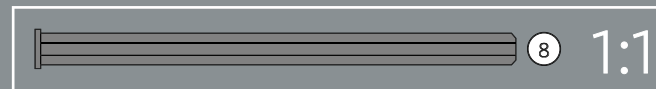
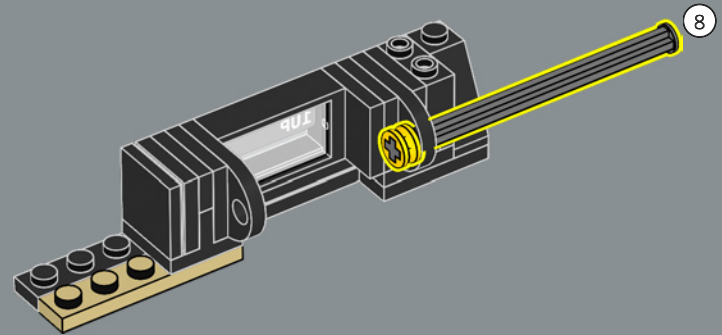

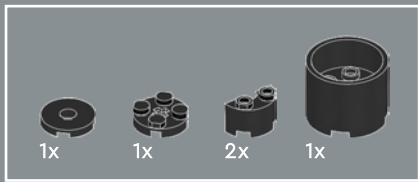

# 240

3,333,360 is the maximum score you can get on the first 255 levels.

3 333 360 est le plus haut score que vous pouvez obtenir dans les 255 premiers niveaux.

3.333.360 es la puntuación máxima que puedes obtener en los primeros 255 niveles.

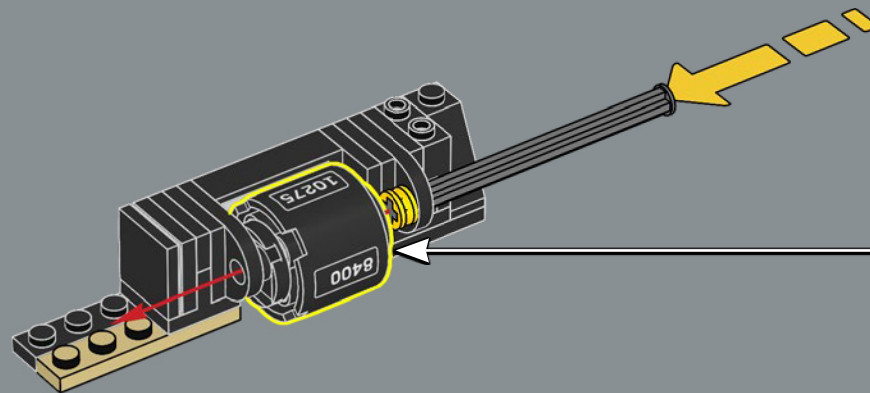
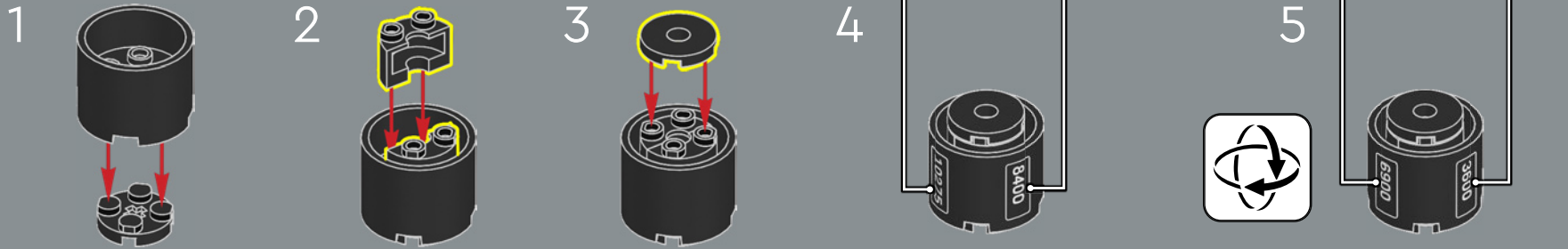



1x

241

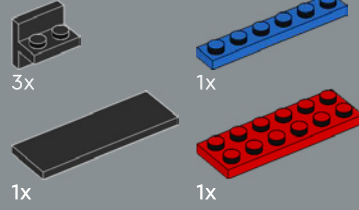
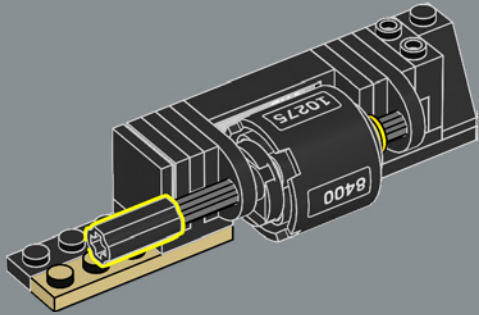

242

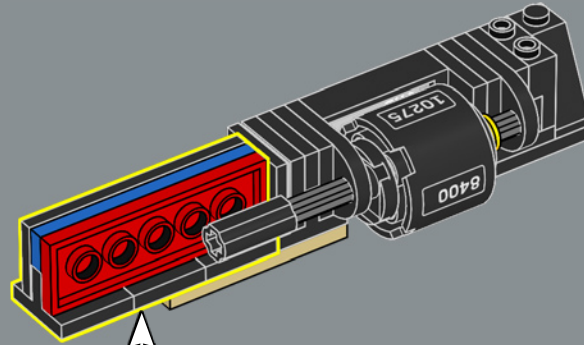

- 1
- 2
- 3
- 4
- 5



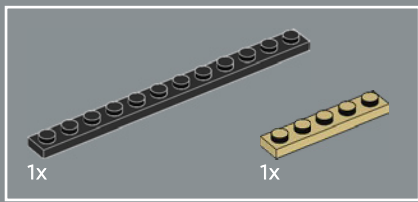

243

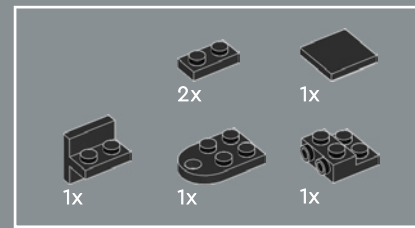
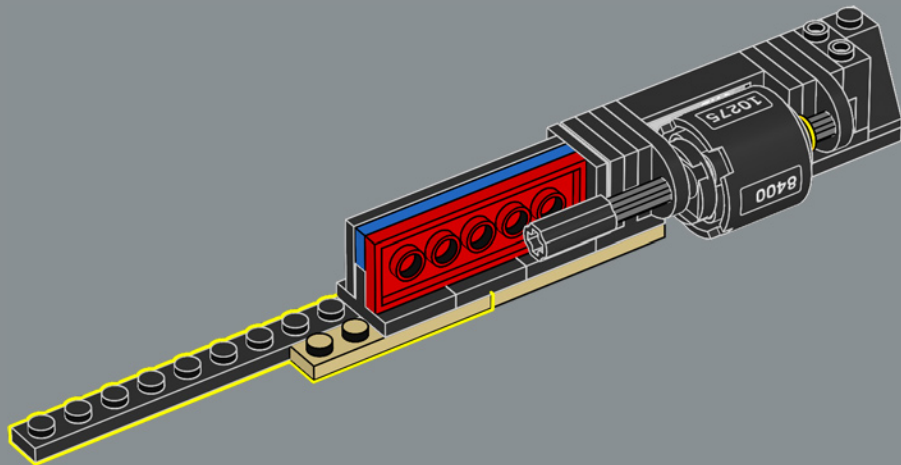

244

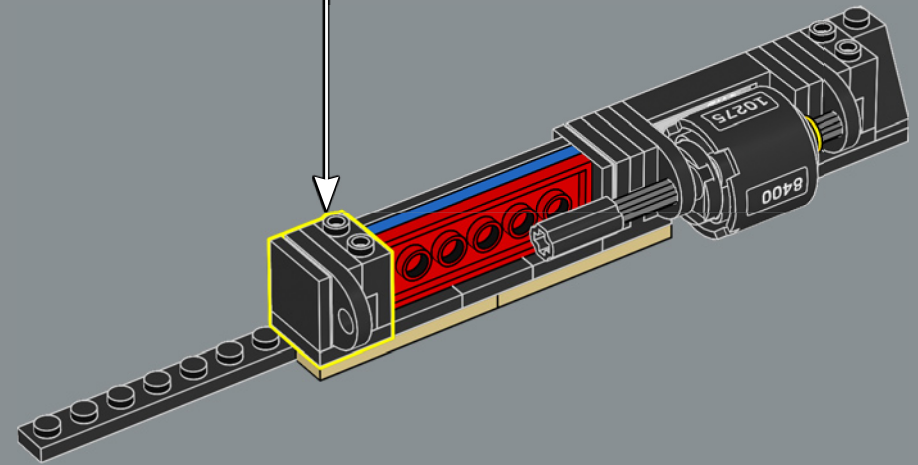
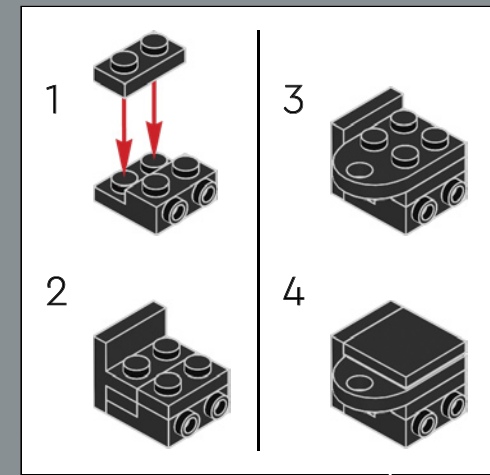

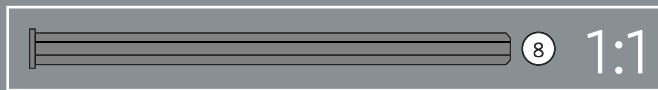
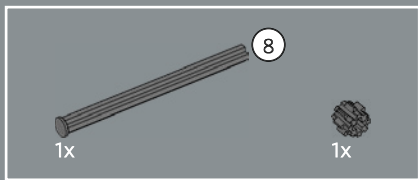

245

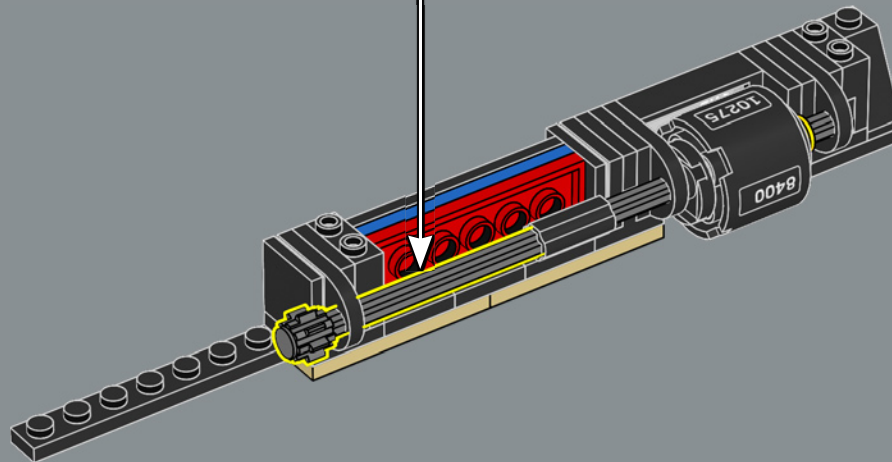
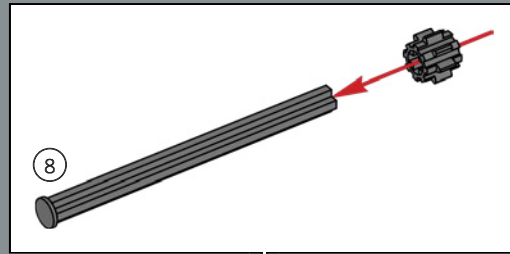

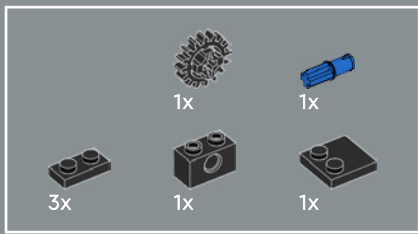

246

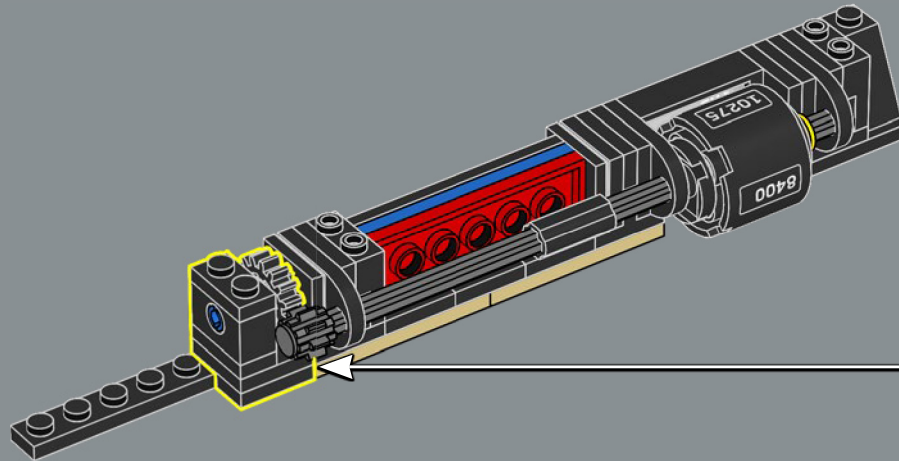
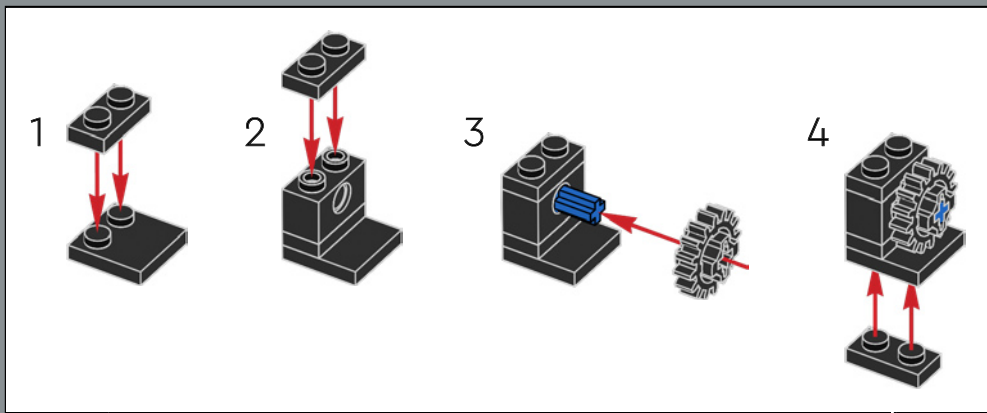

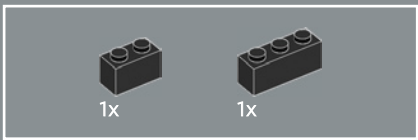

247

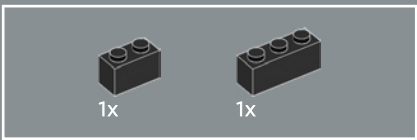
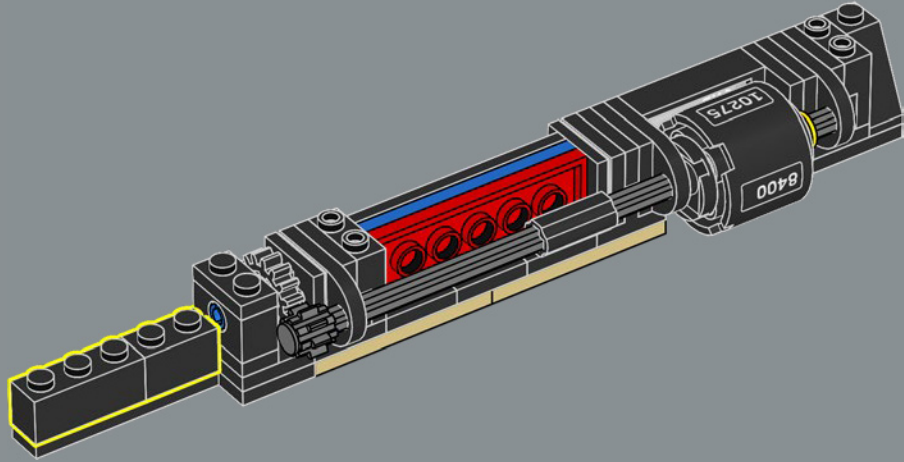

248

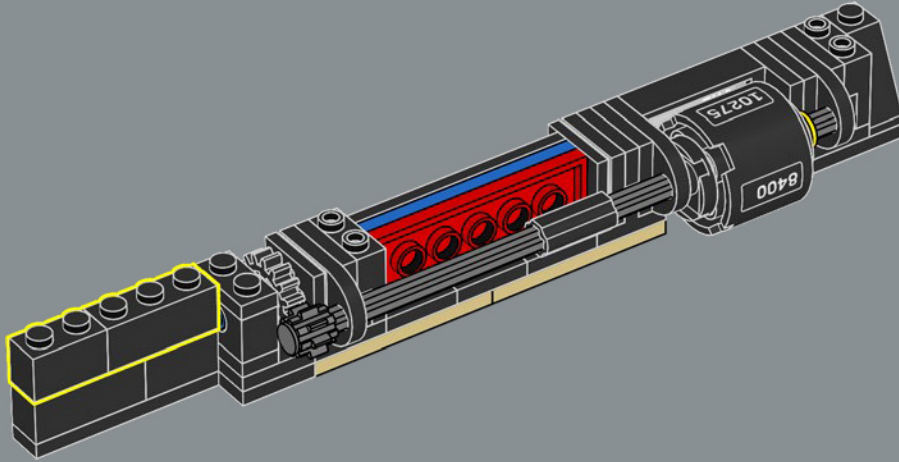

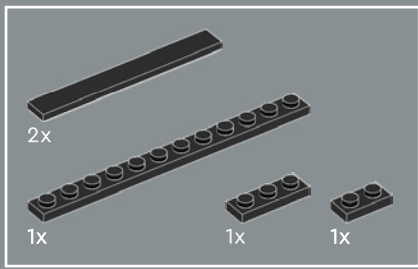

249

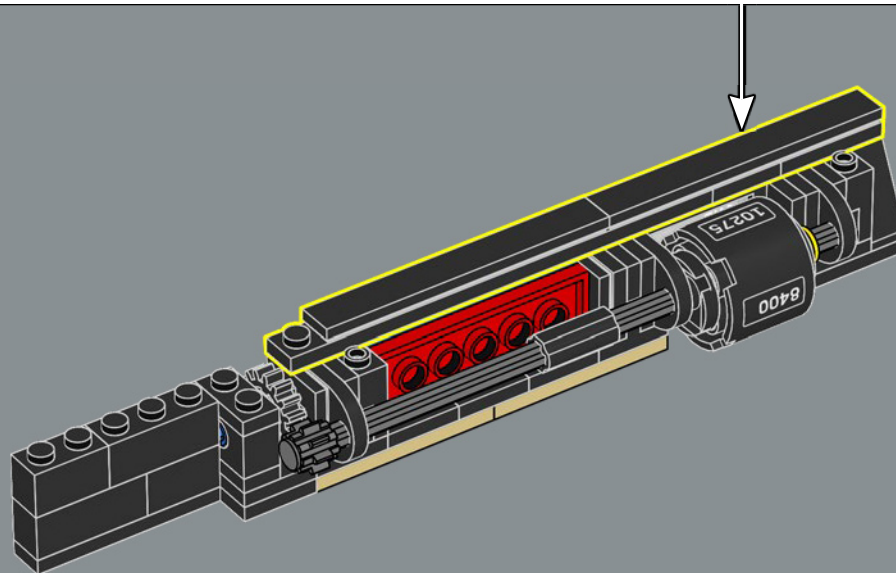
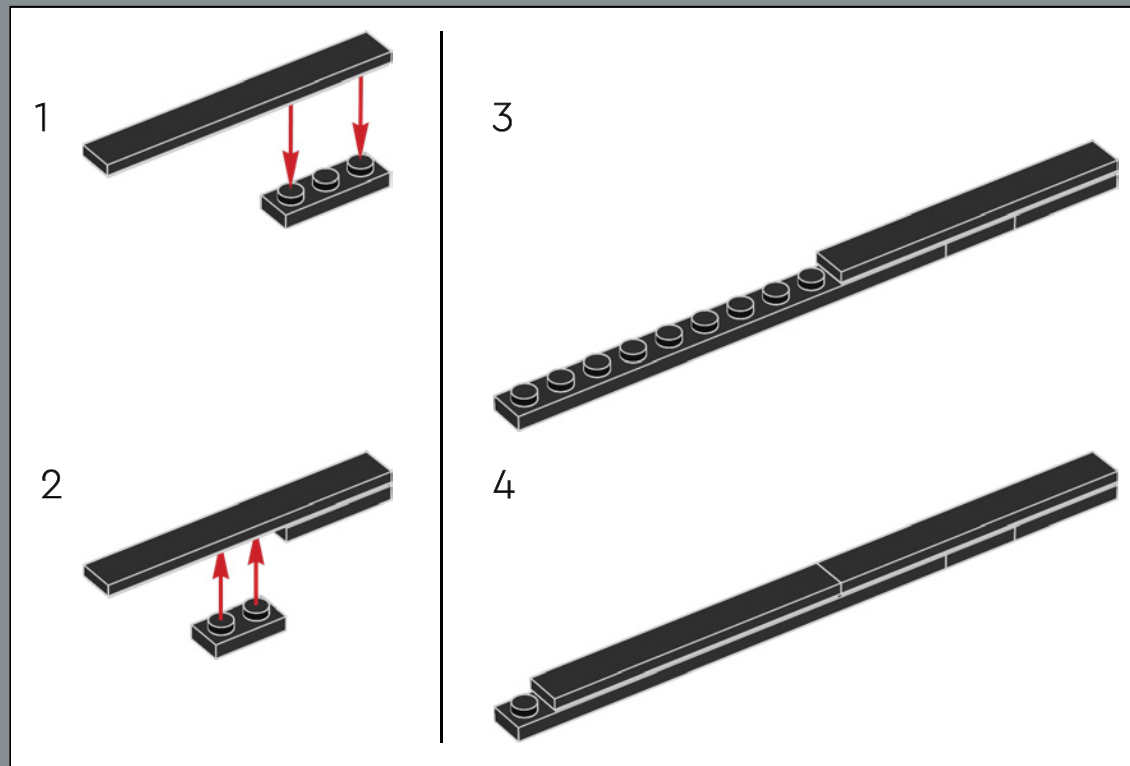

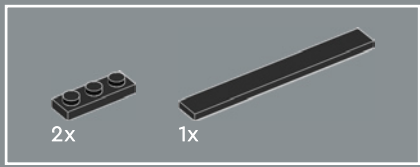

250

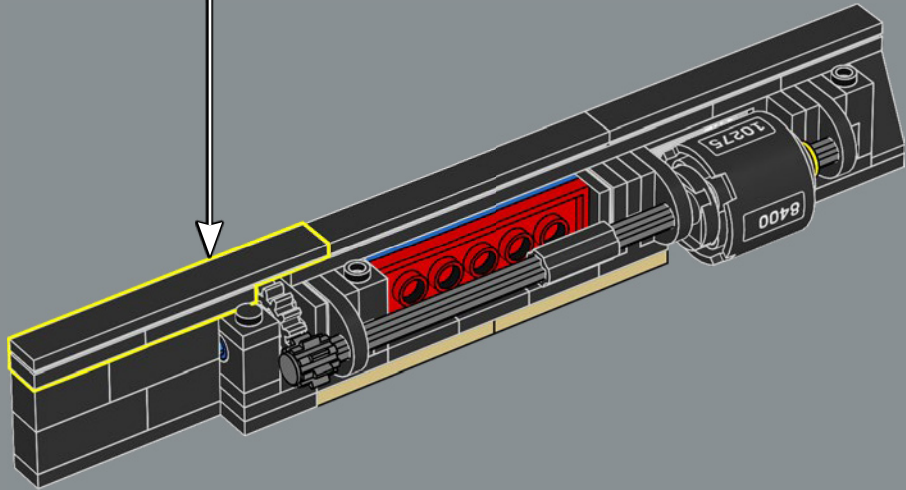
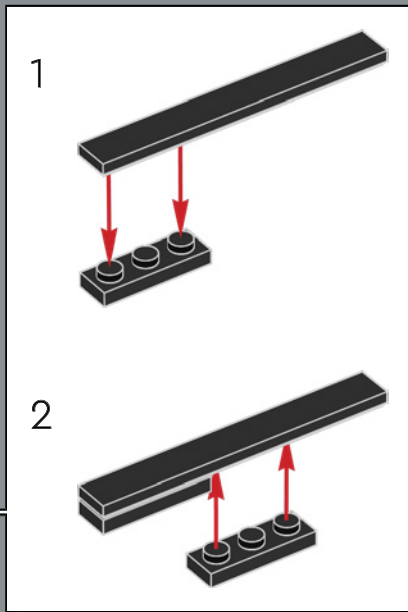

251

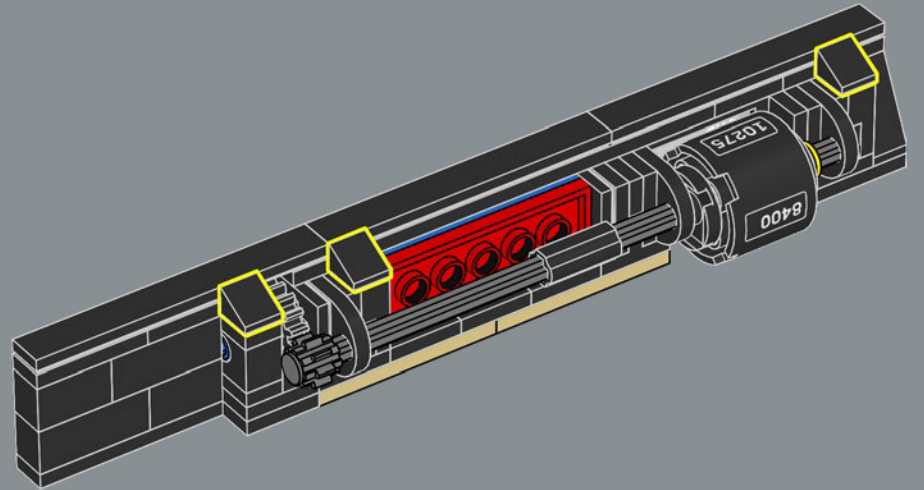

252

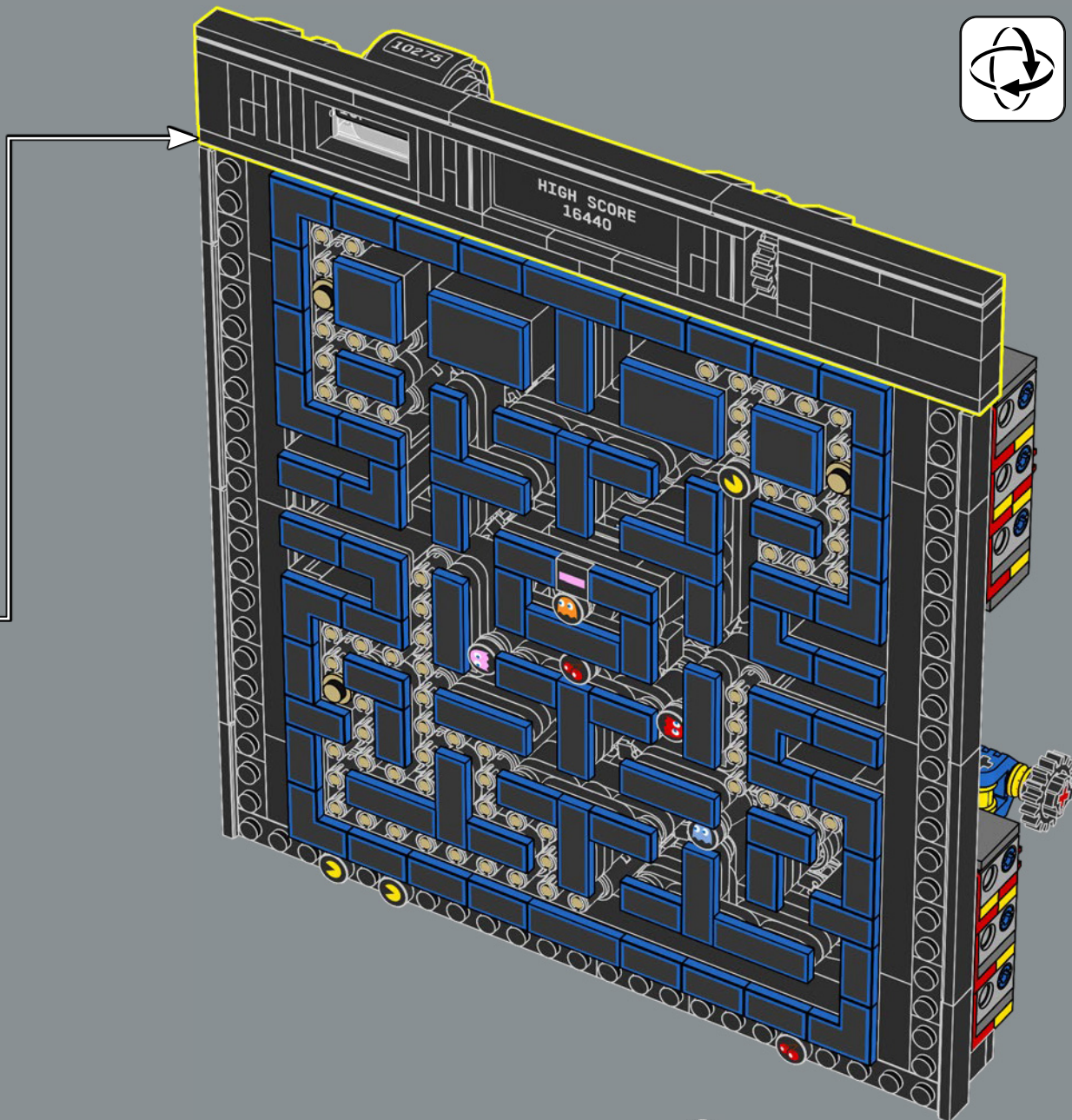

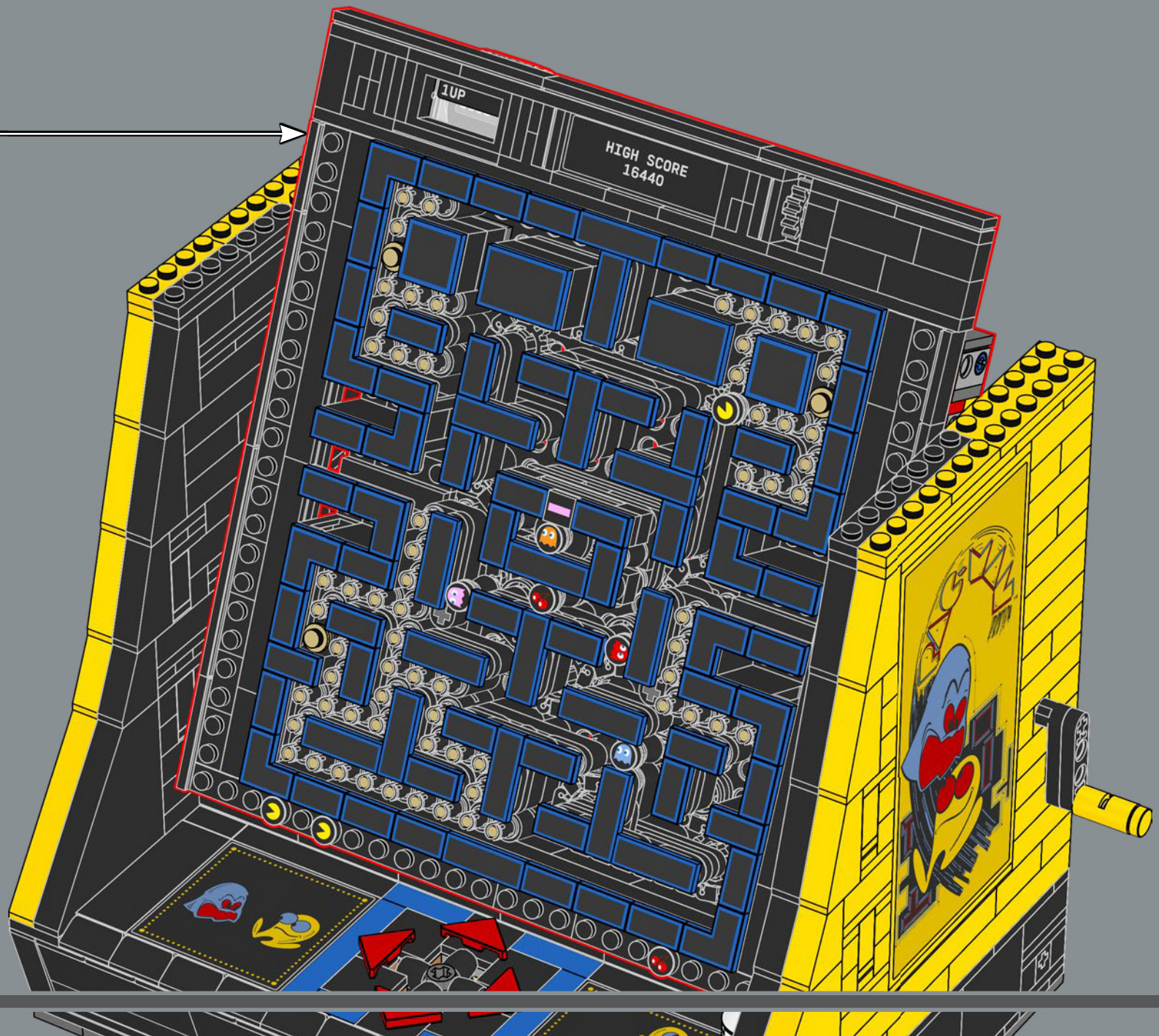



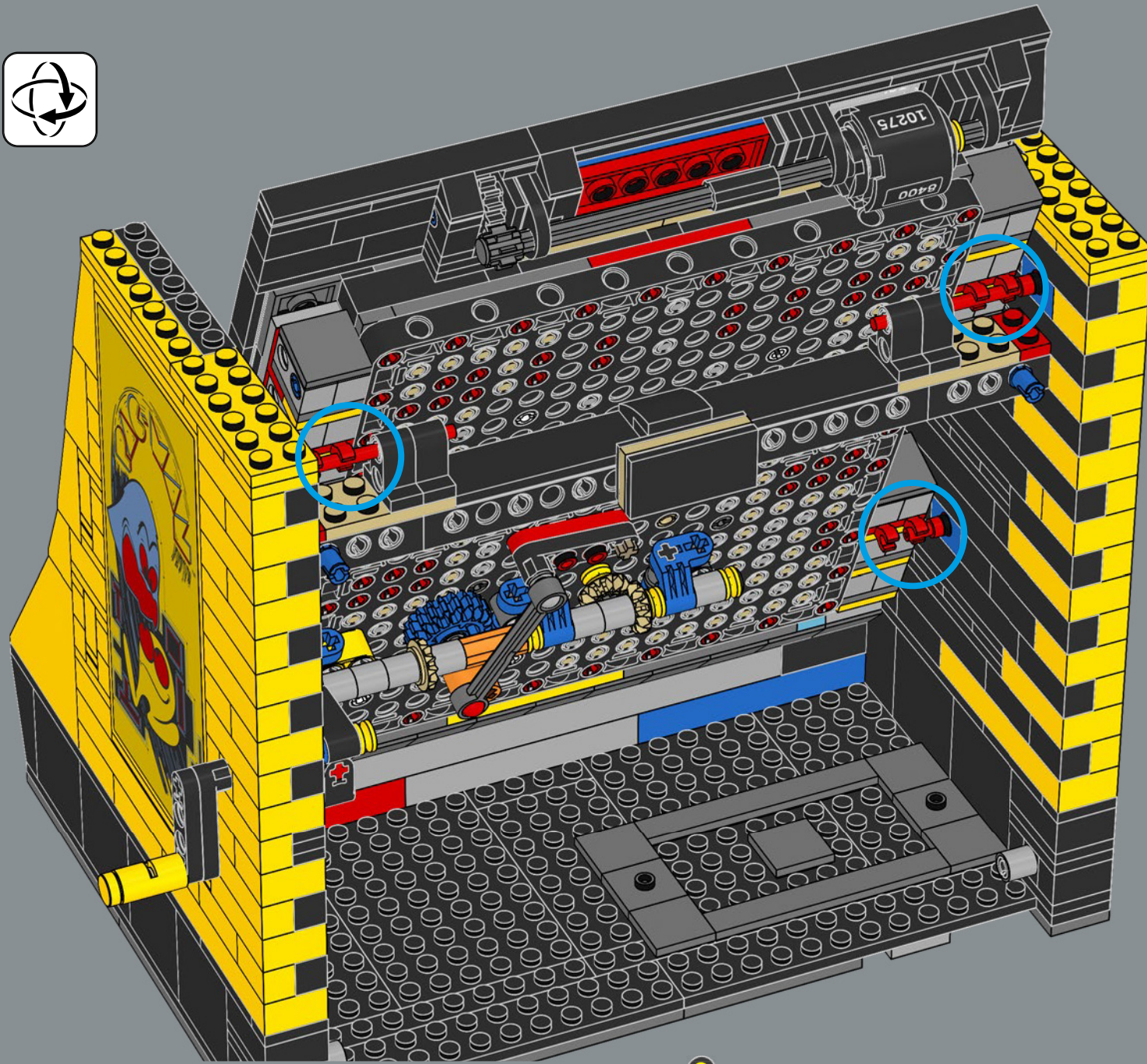



The biggest challenge was getting the ghosts to turn corners without getting stuck. We used a robot to test it thousands of times to make sure it's solid!

Le plus grand défi a été de permettre aux fantômes d'effectuer des virages sans se coincer. Nous avons utilisé un robot pour le tester des milliers de fois afin de nous assurer de sa solidité !

El mayor reto fue lograr que los fantasmas giraran en las esquinas sin quedarse atascados. ¡Usamos un robot para probarlo miles de veces y asegurarnos de que sea consistente!

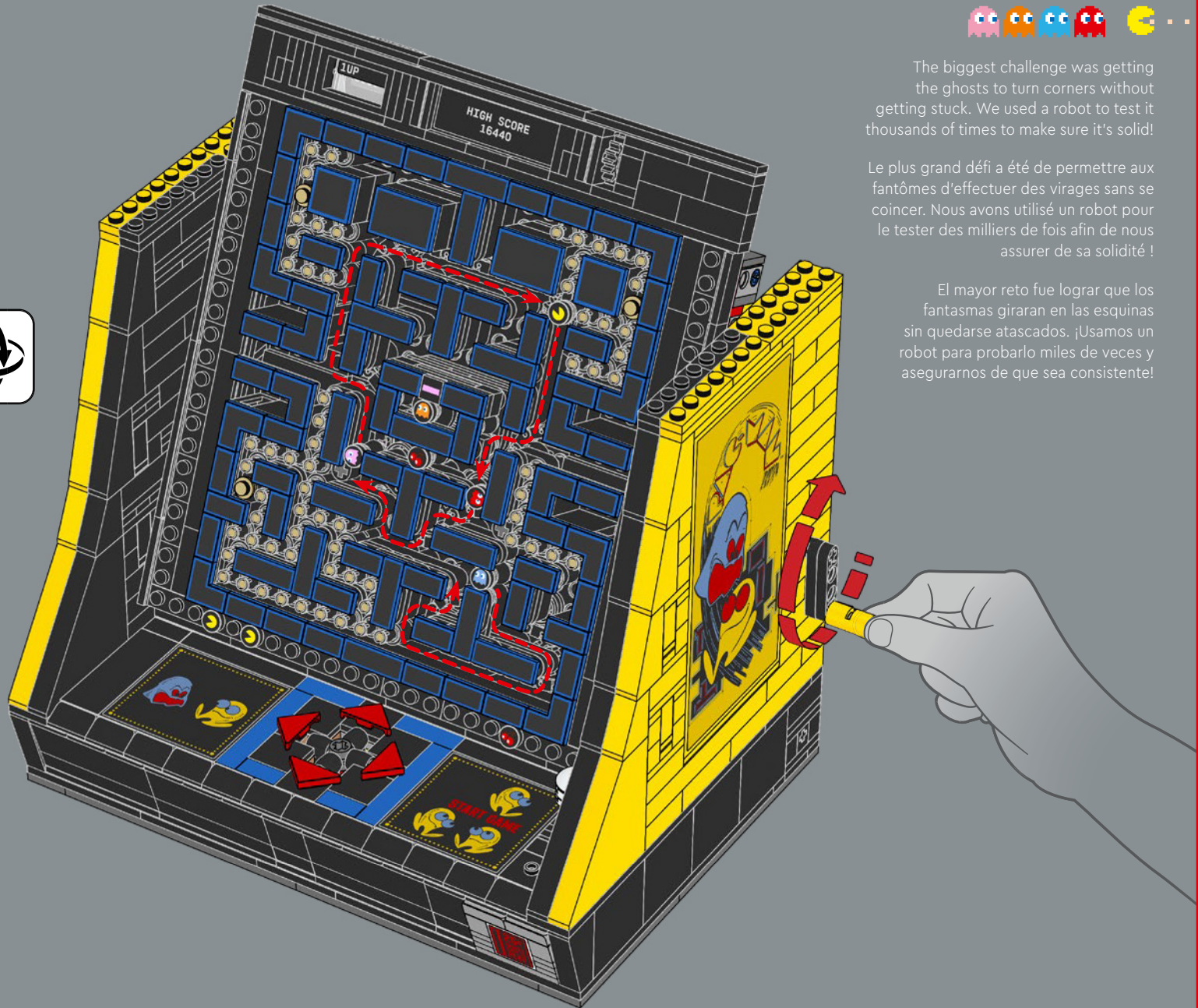

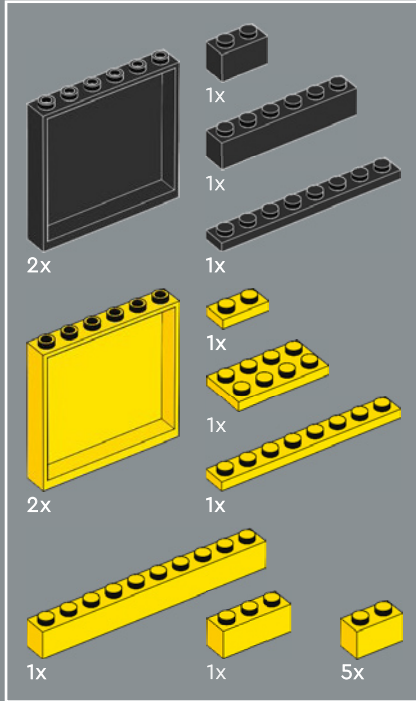
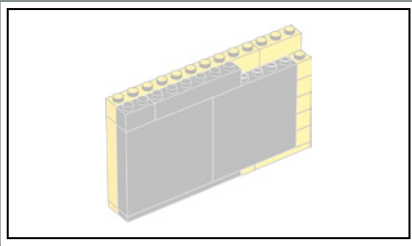

254

1

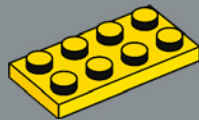

2

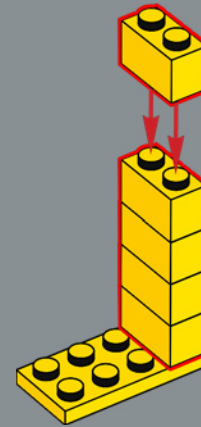

3

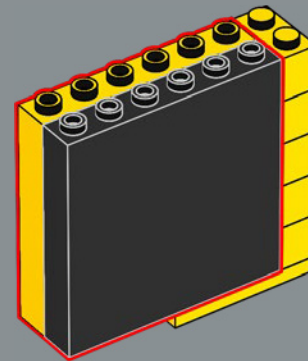

4

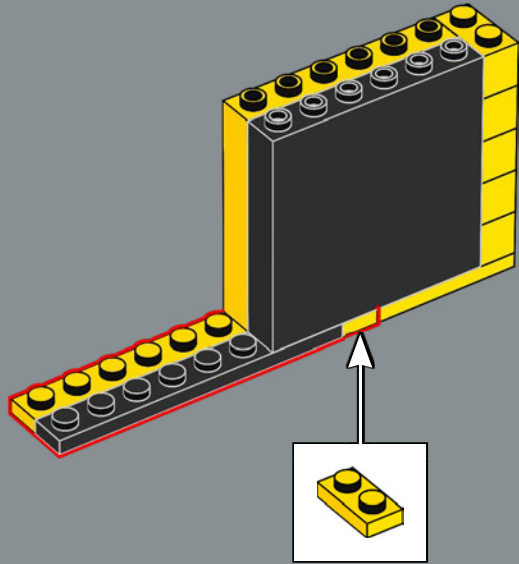

5

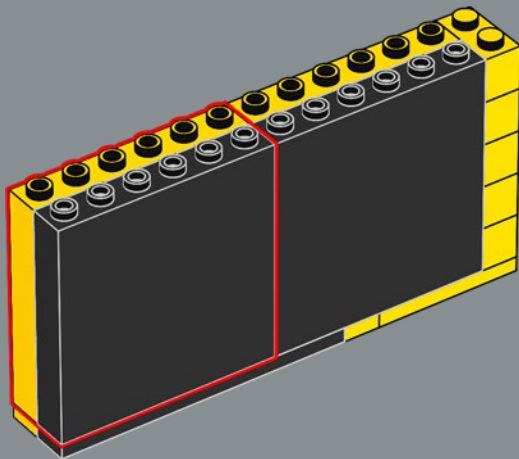

6

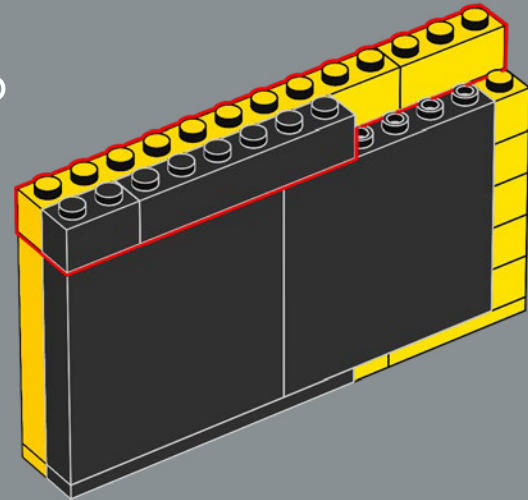

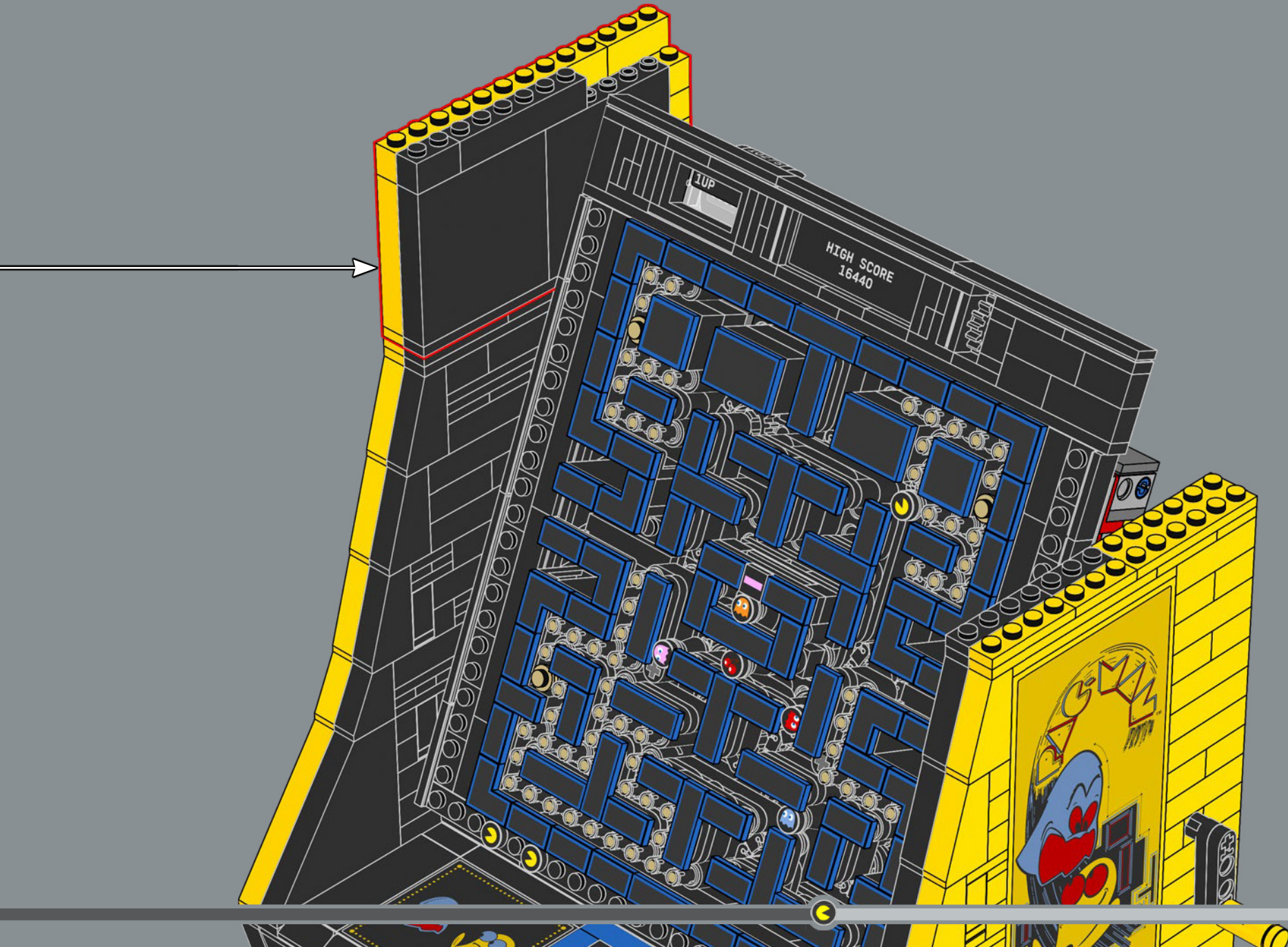

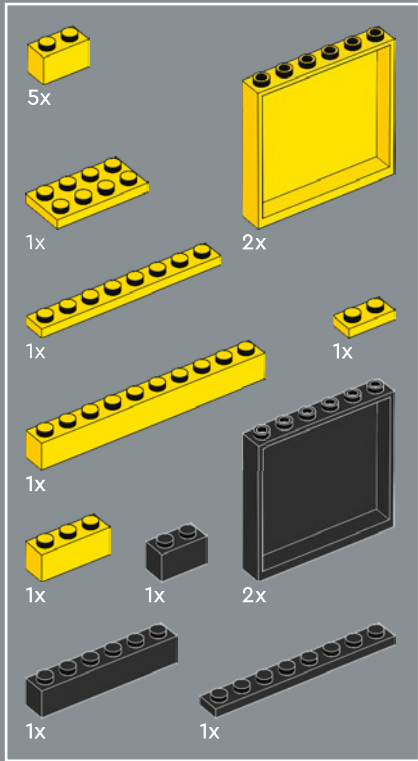
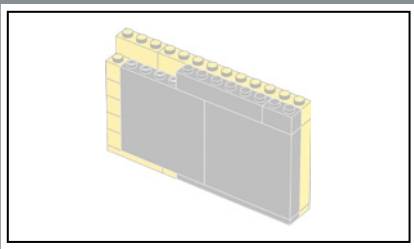

255

1

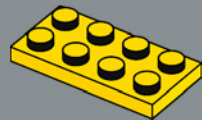

2

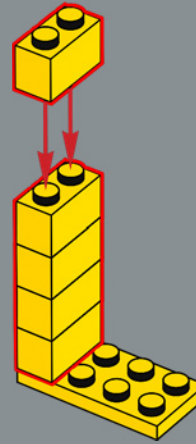

3

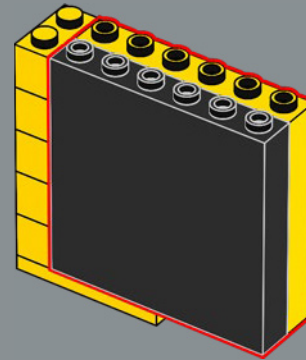

4

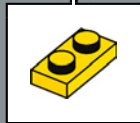
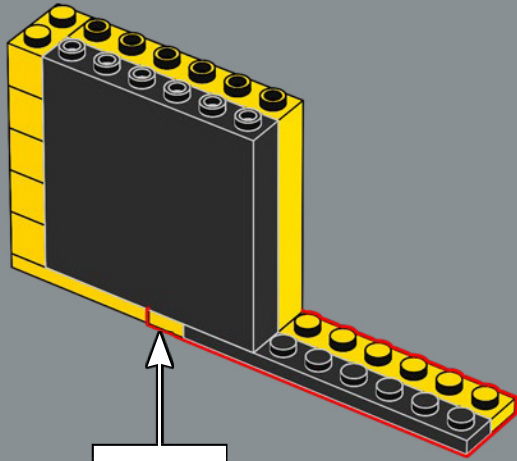

5

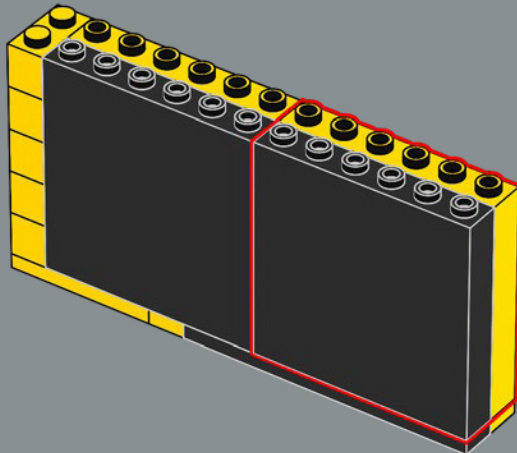

6

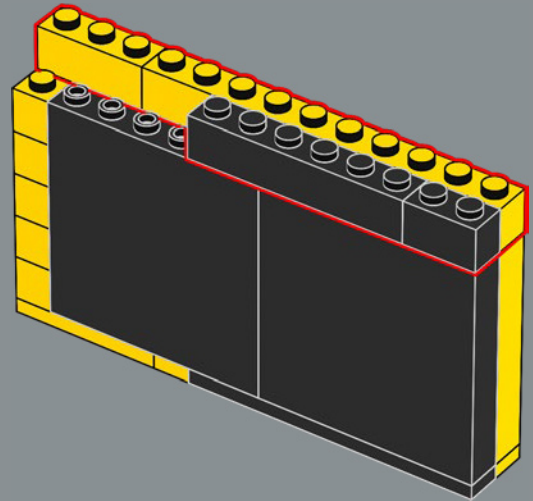

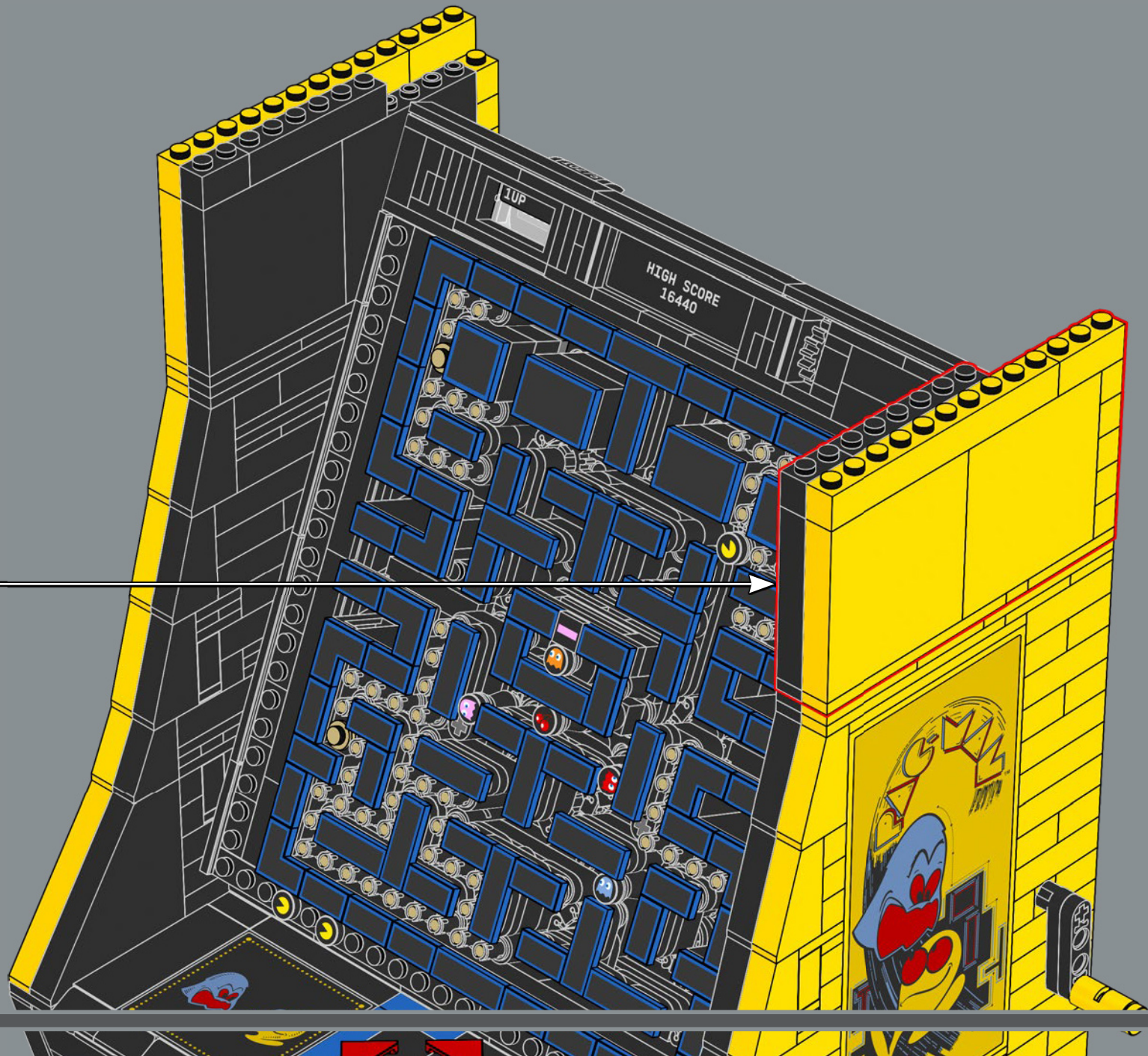



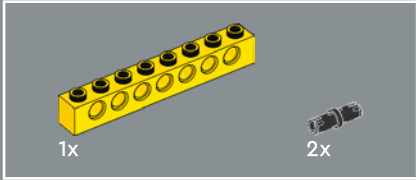
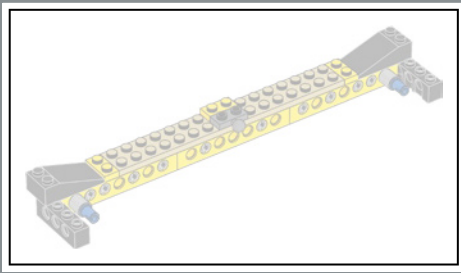

256

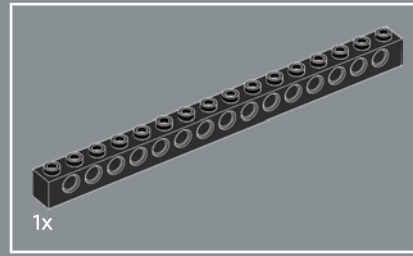
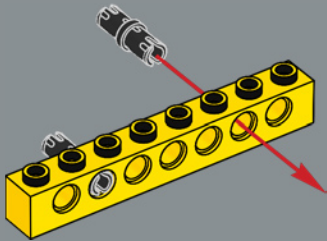

257

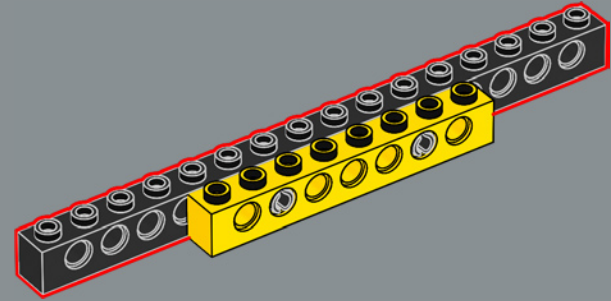

258

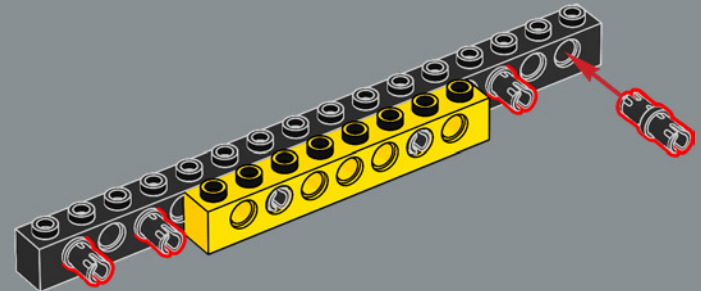

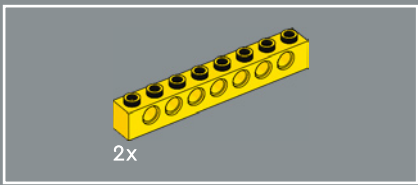

259

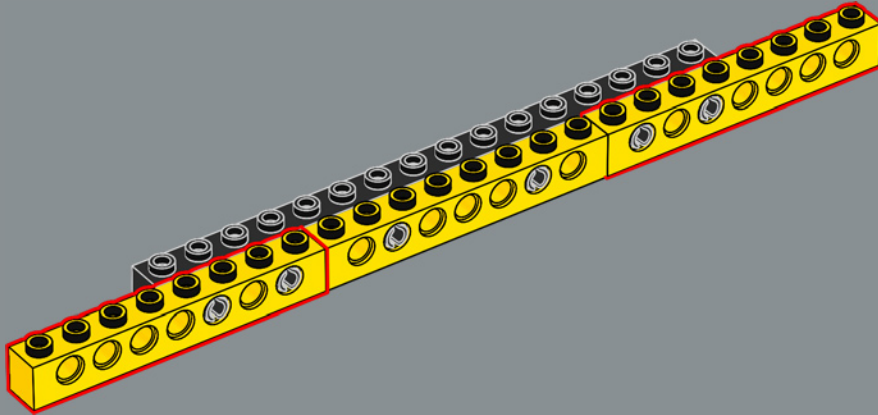

260

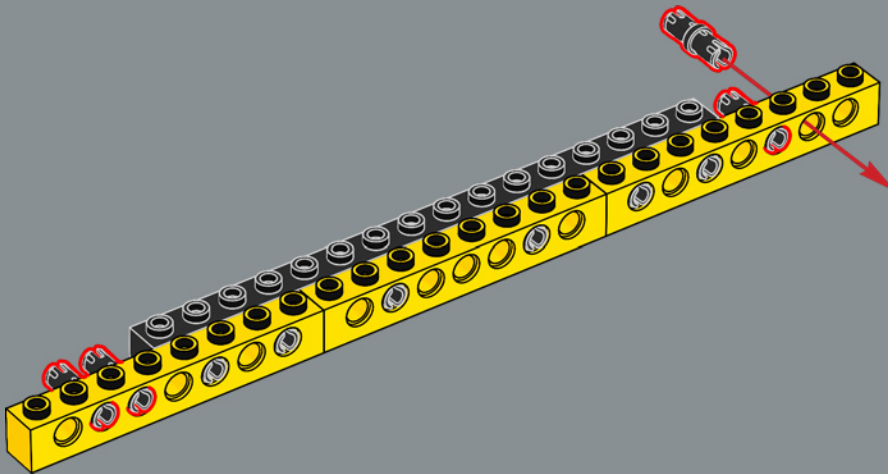

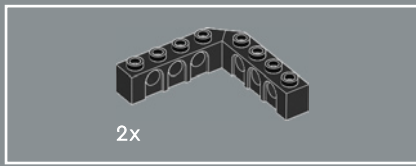

261

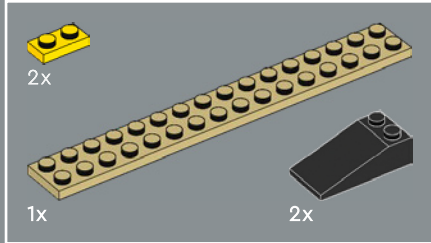
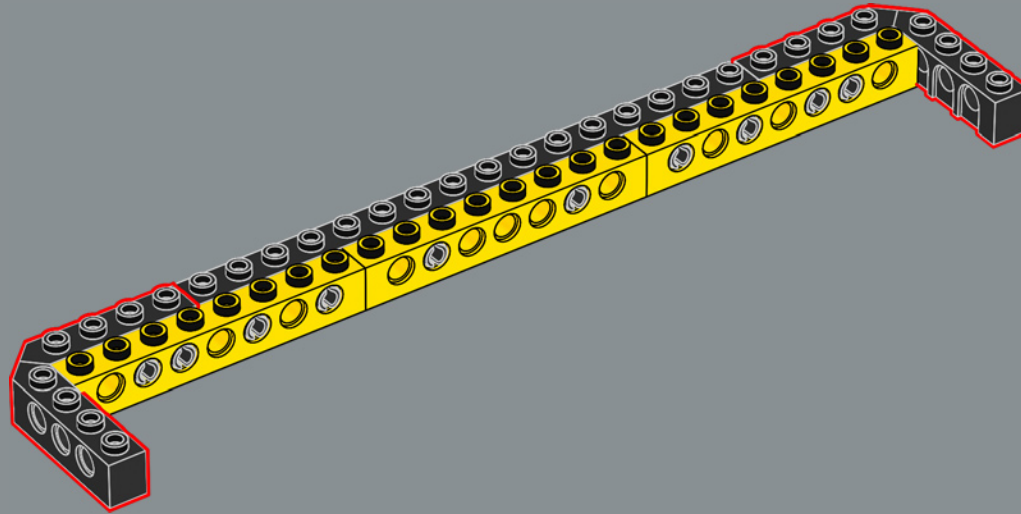

262

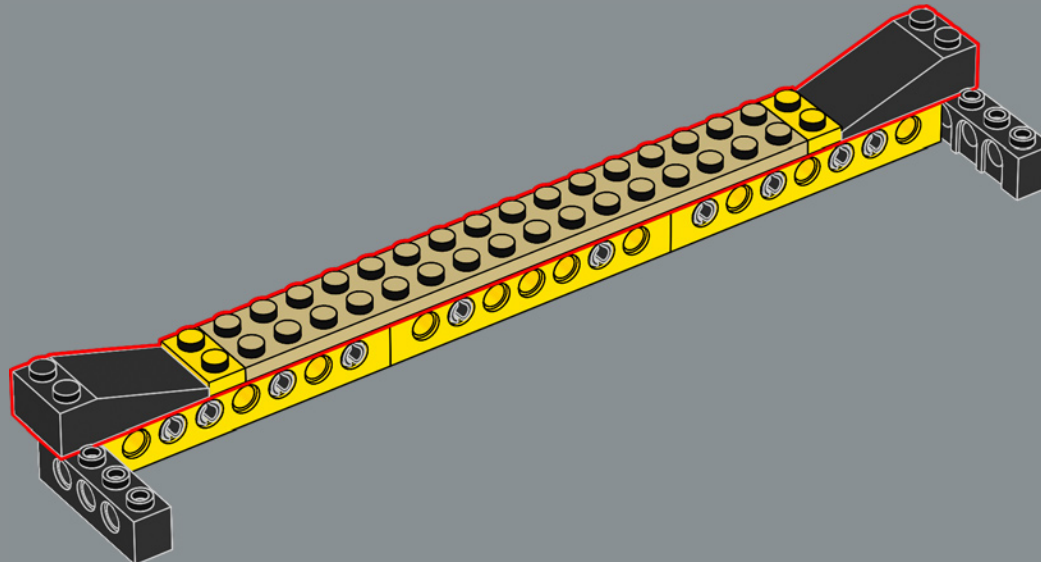

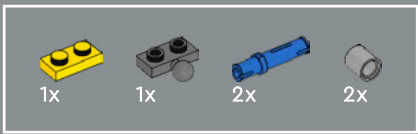

263

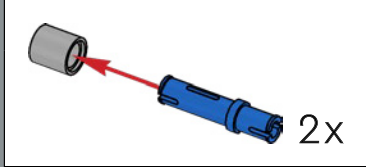
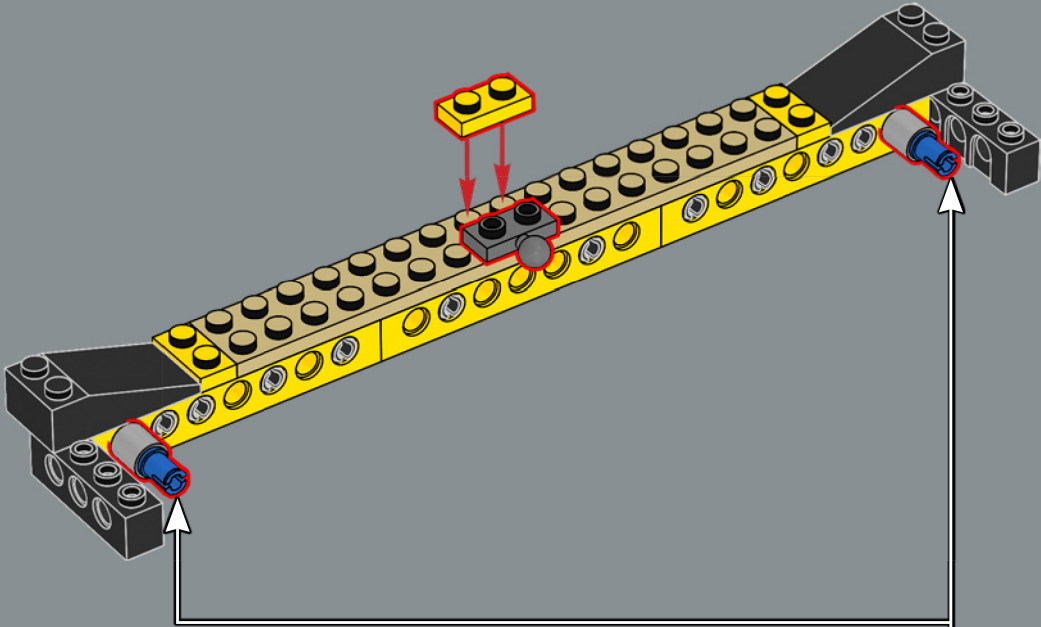

264

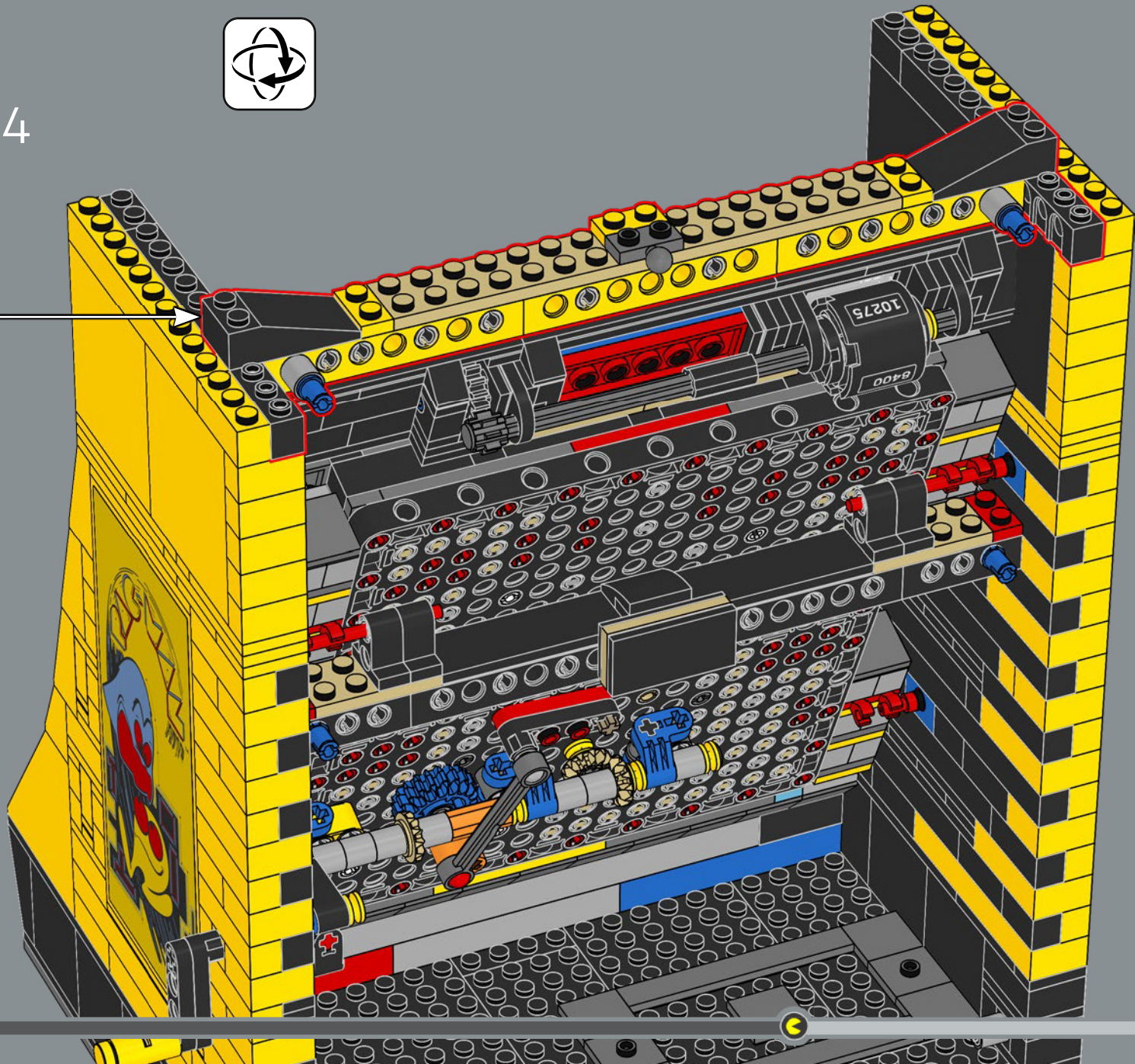

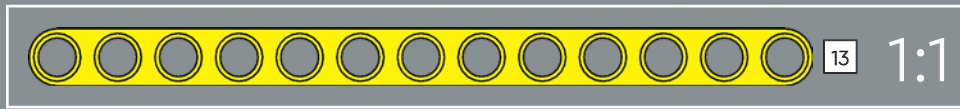
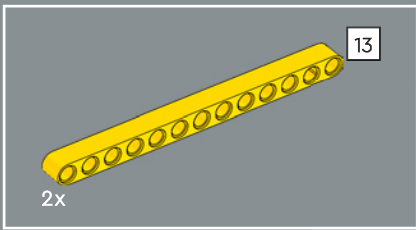

265

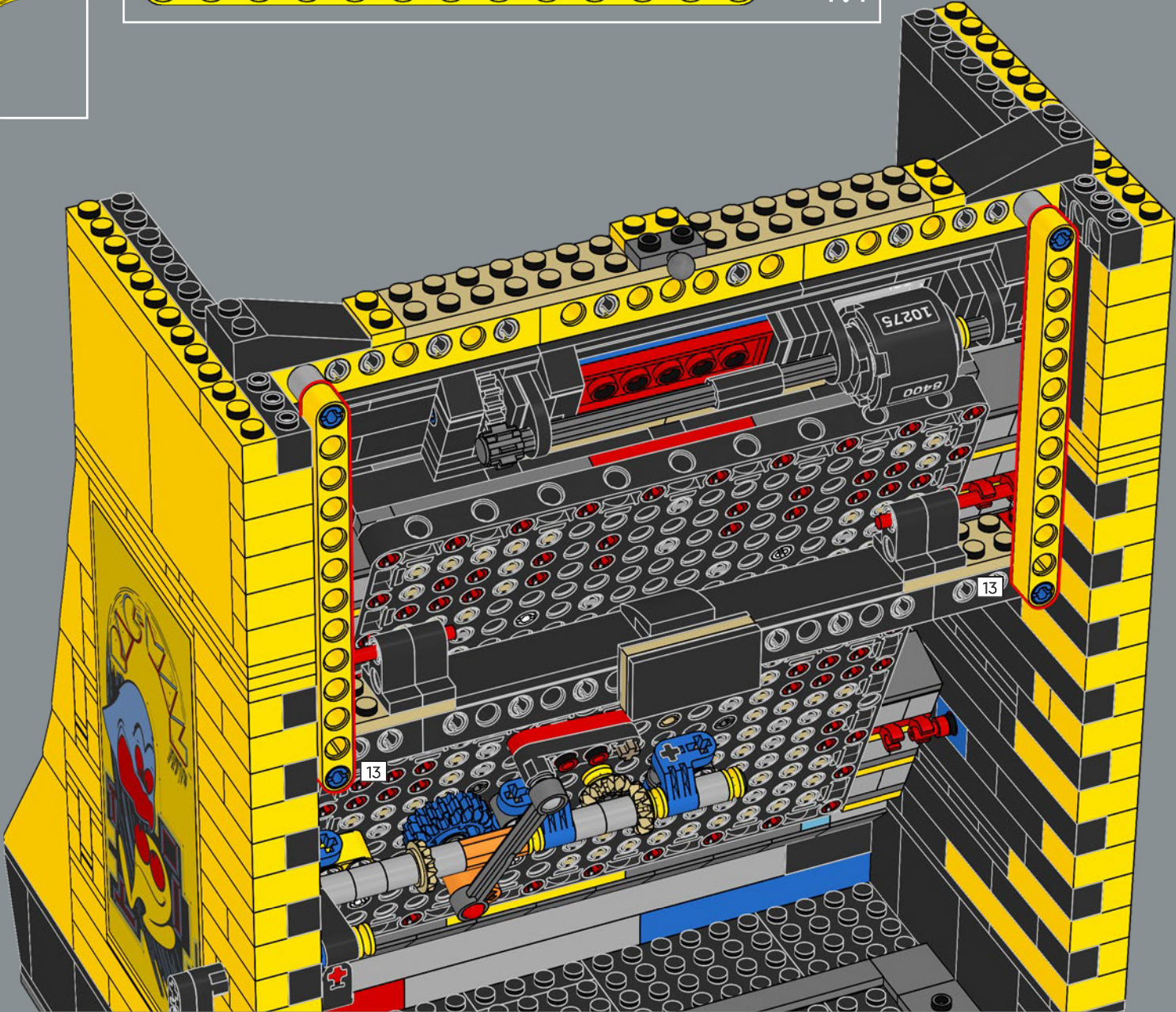



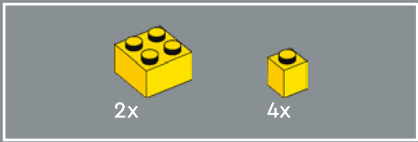

266

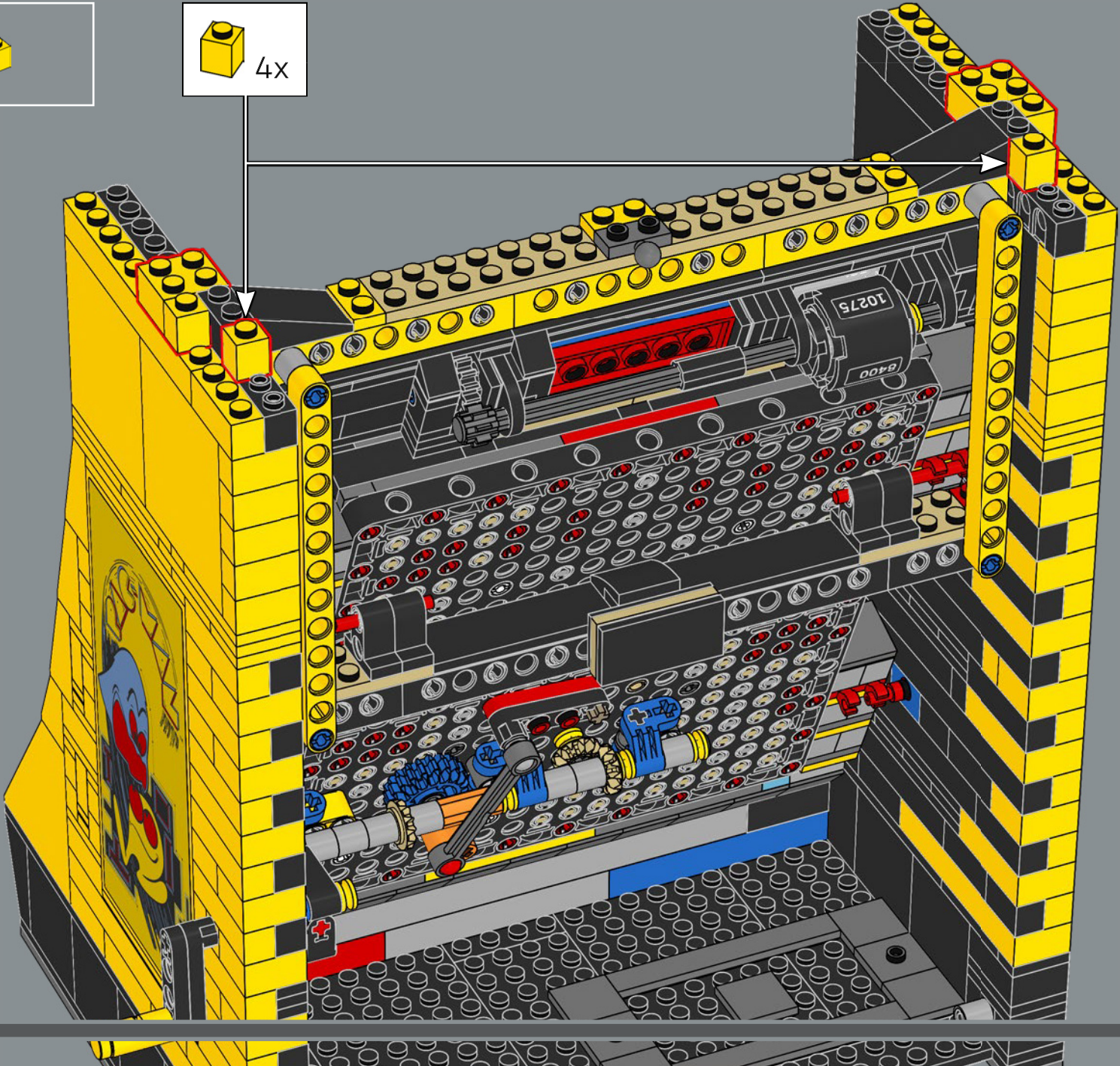



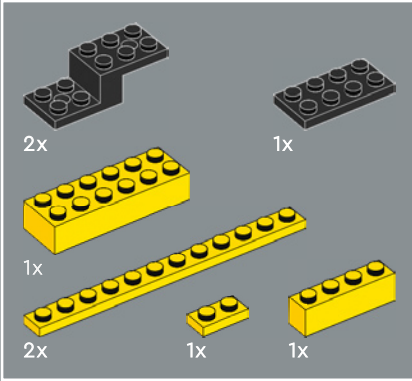
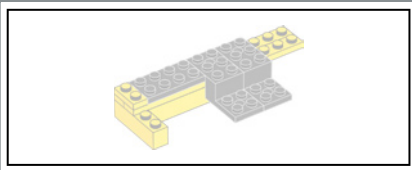

267

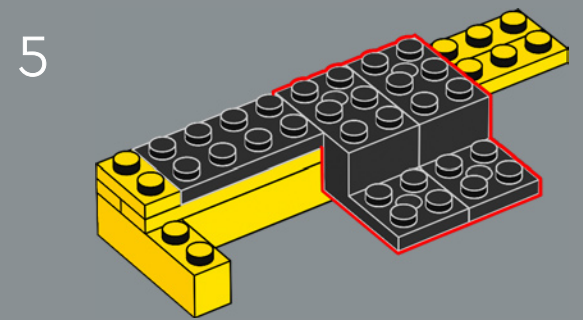
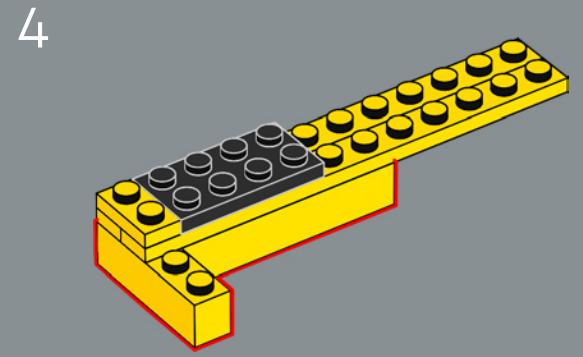
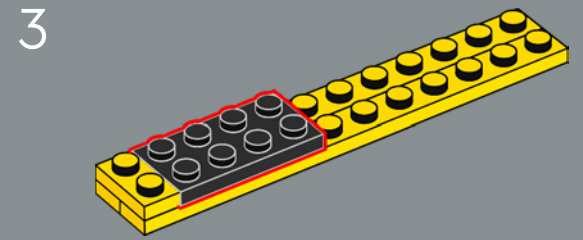
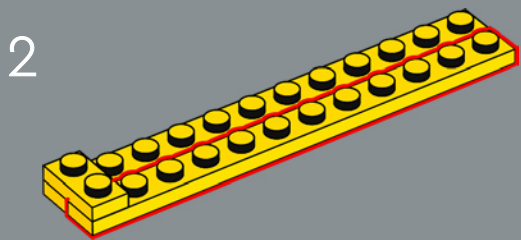
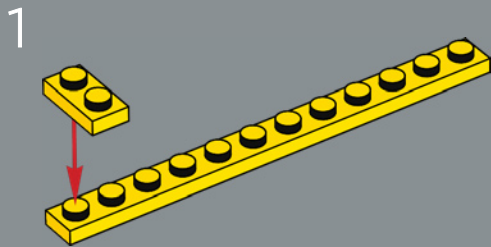

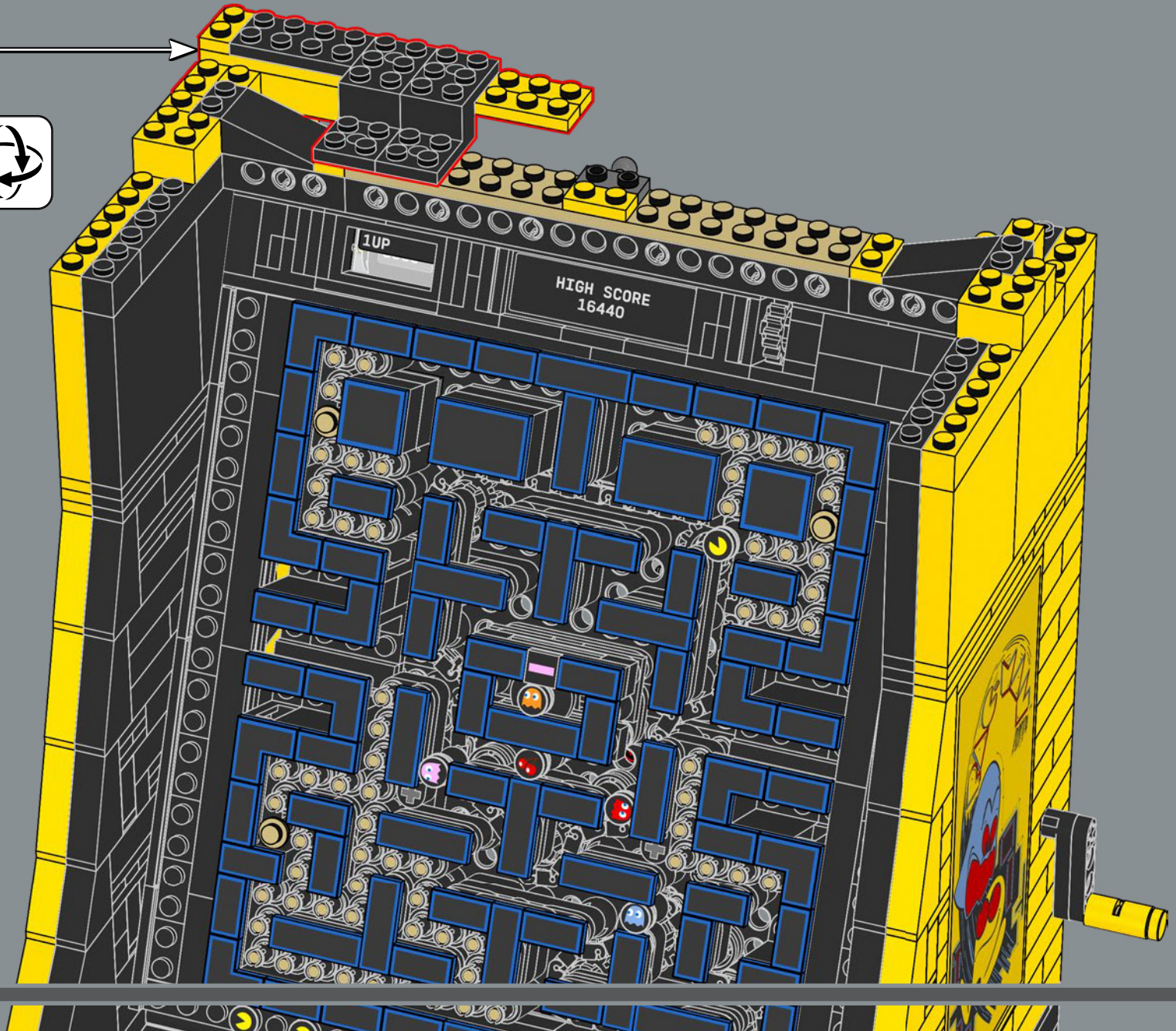

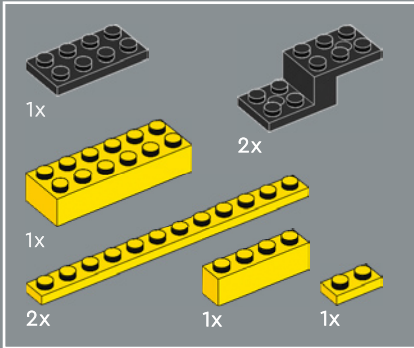
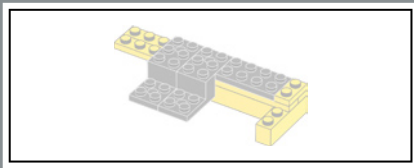

268

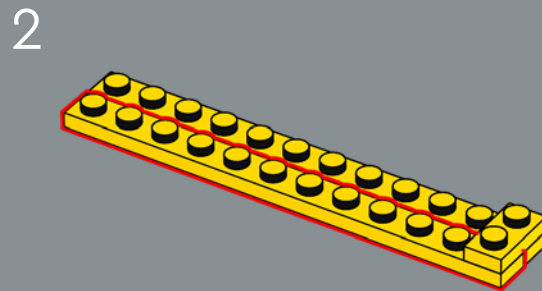
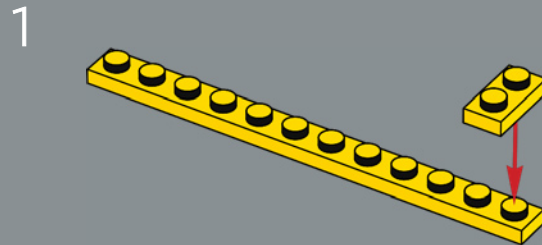

3

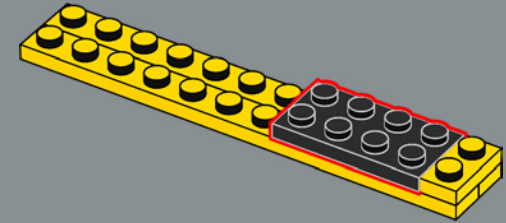

4

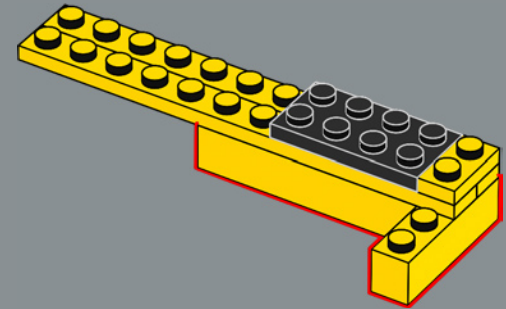

5

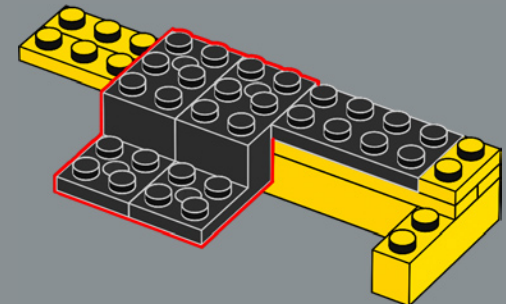

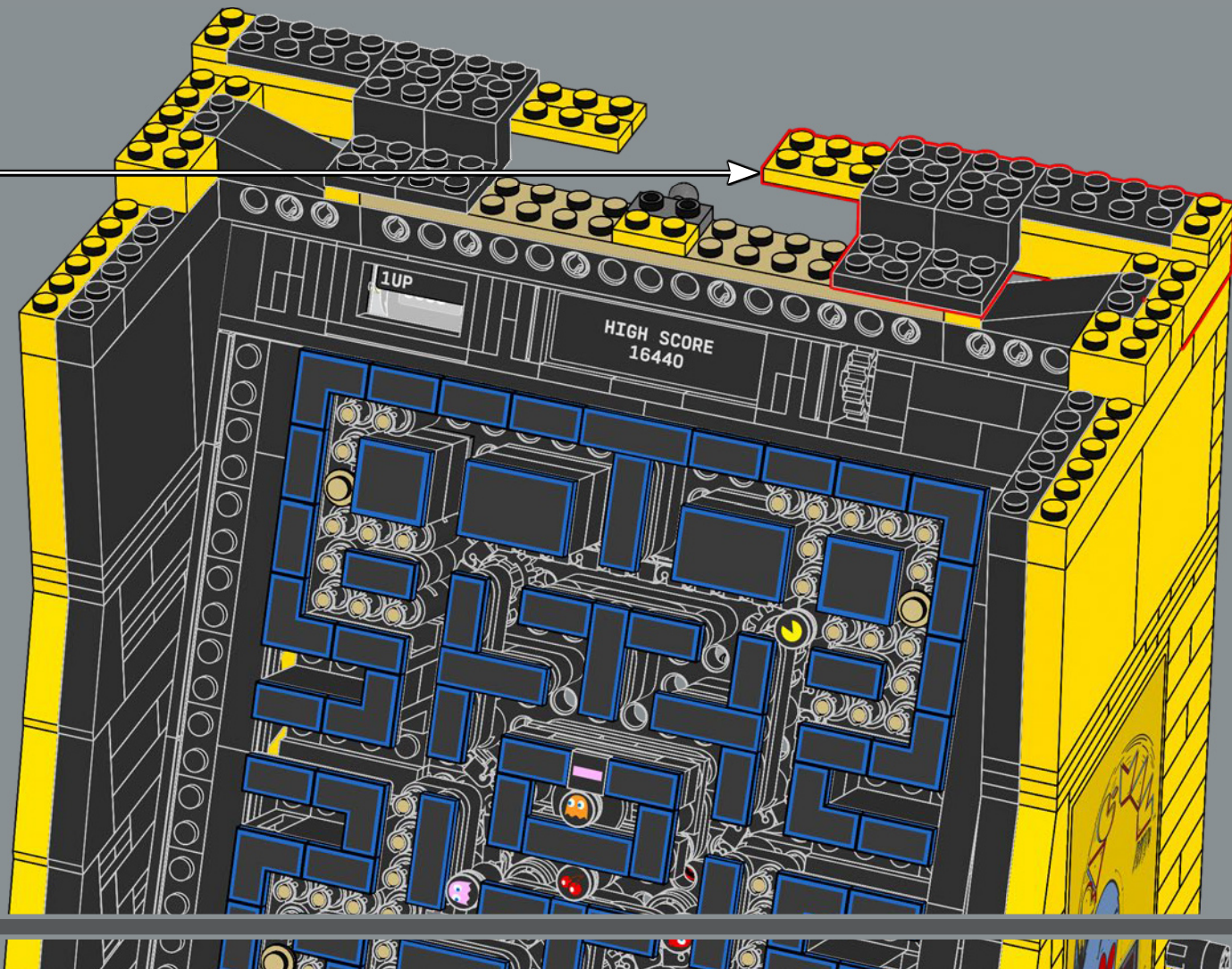

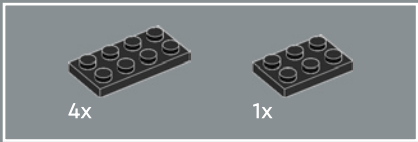

269

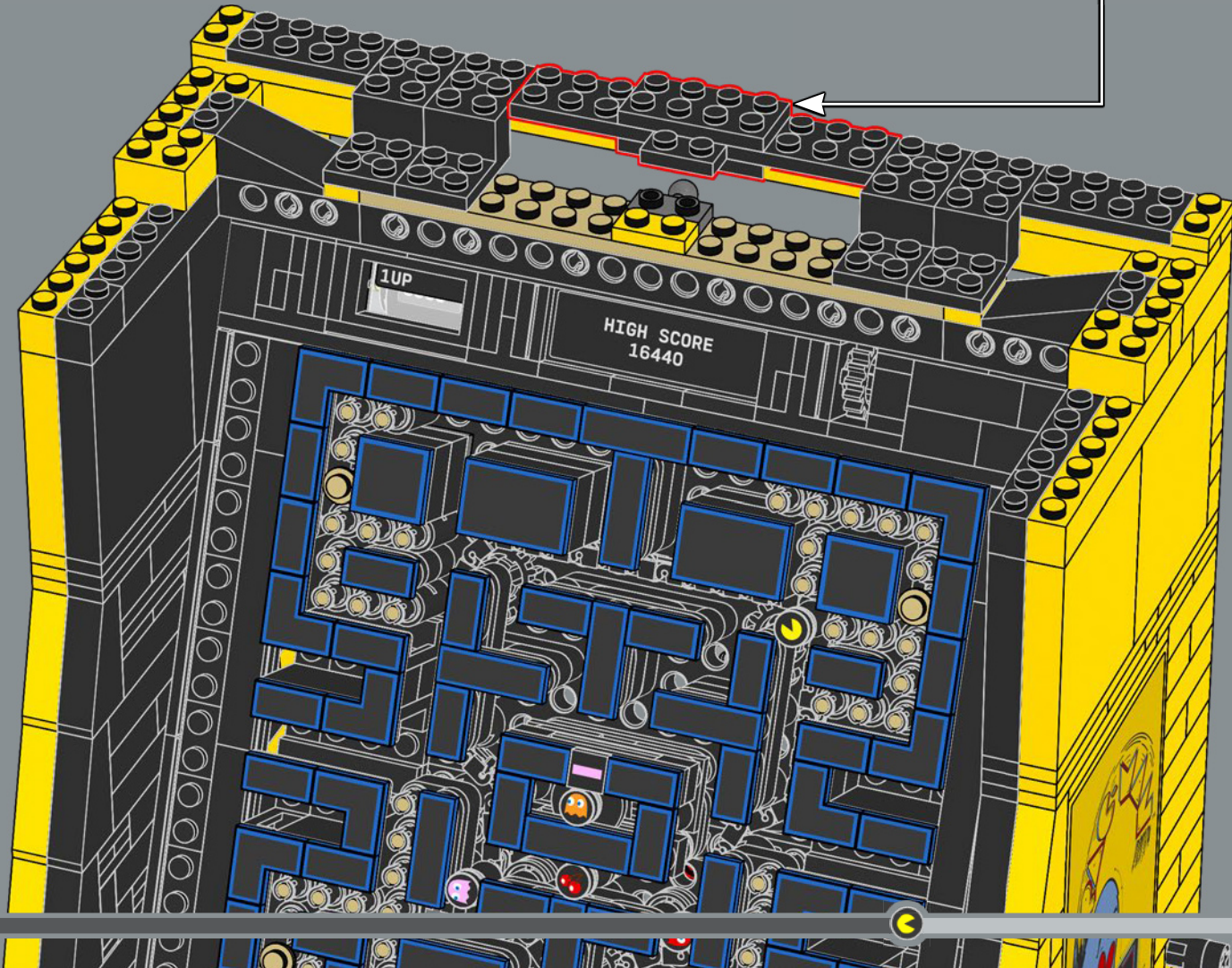
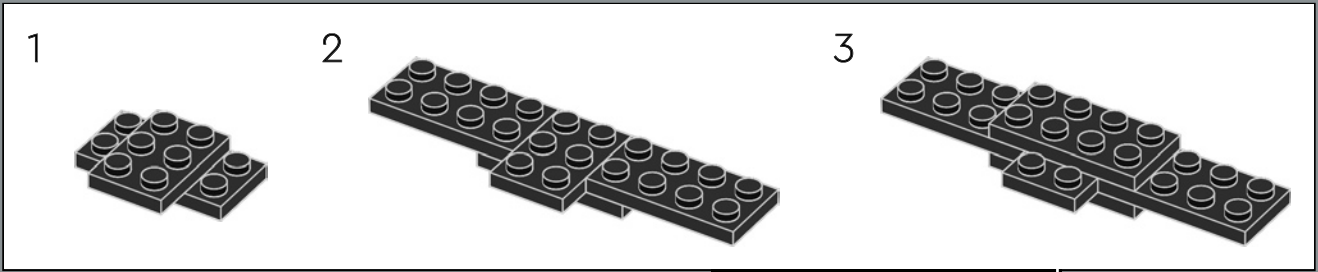

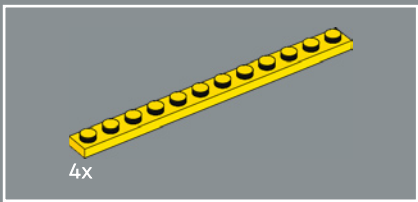

270

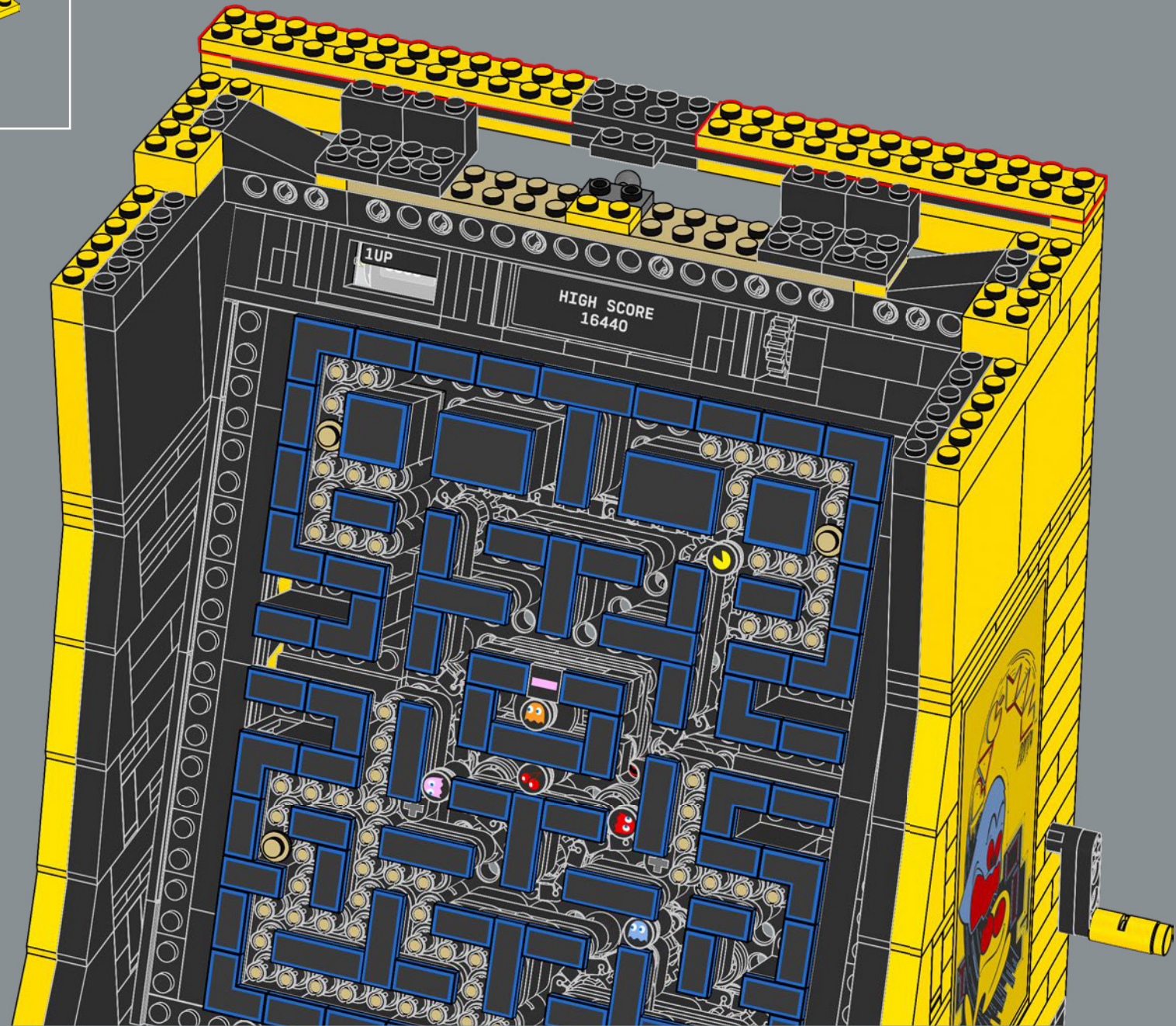

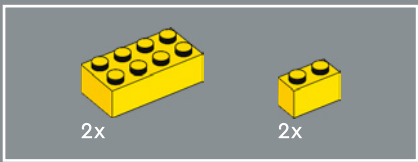

271

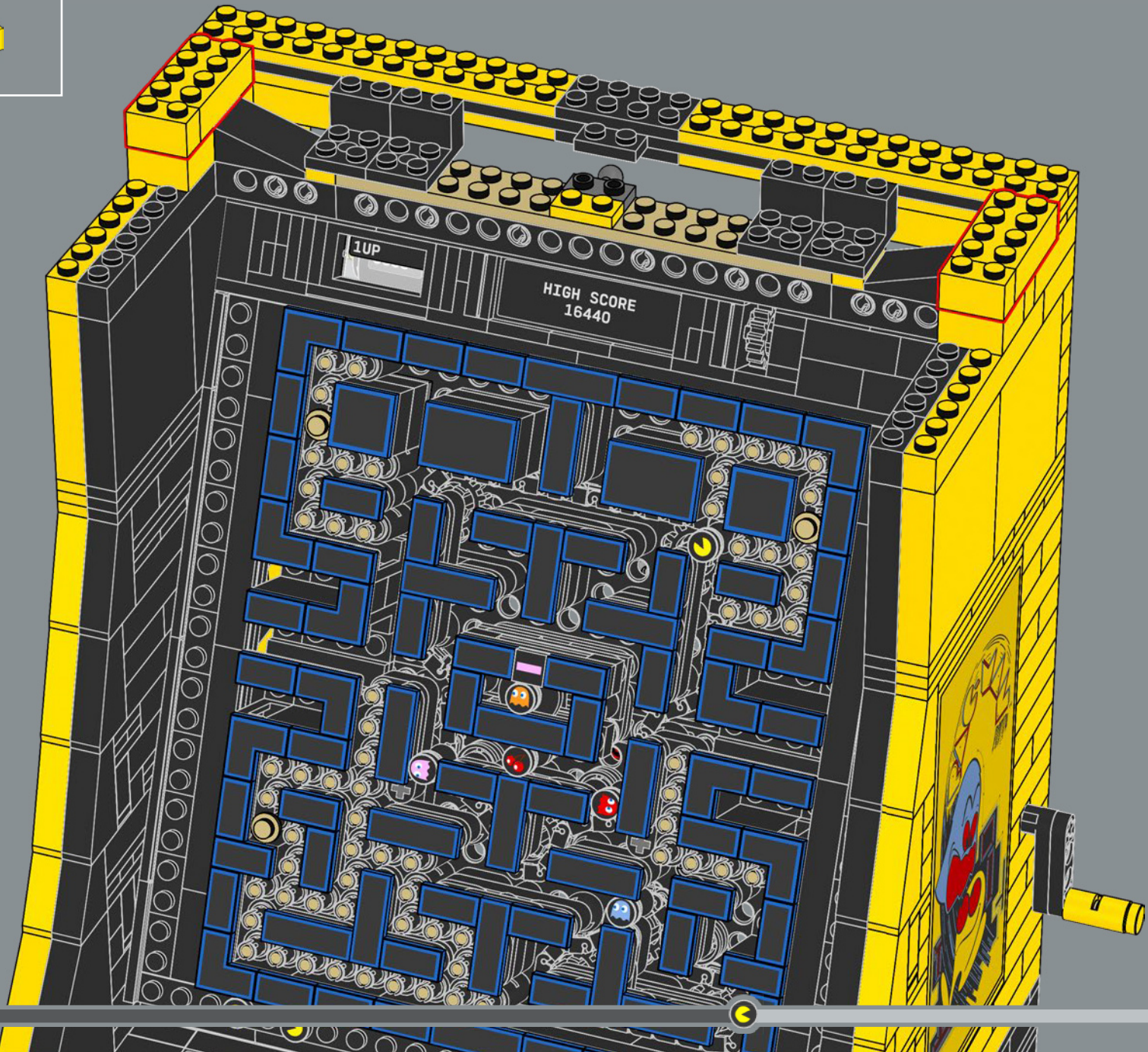

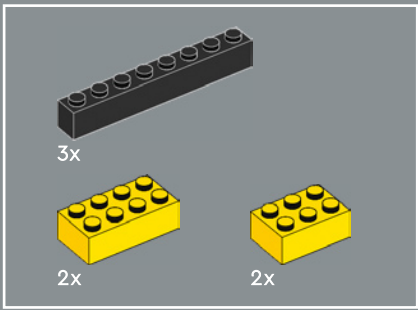

272

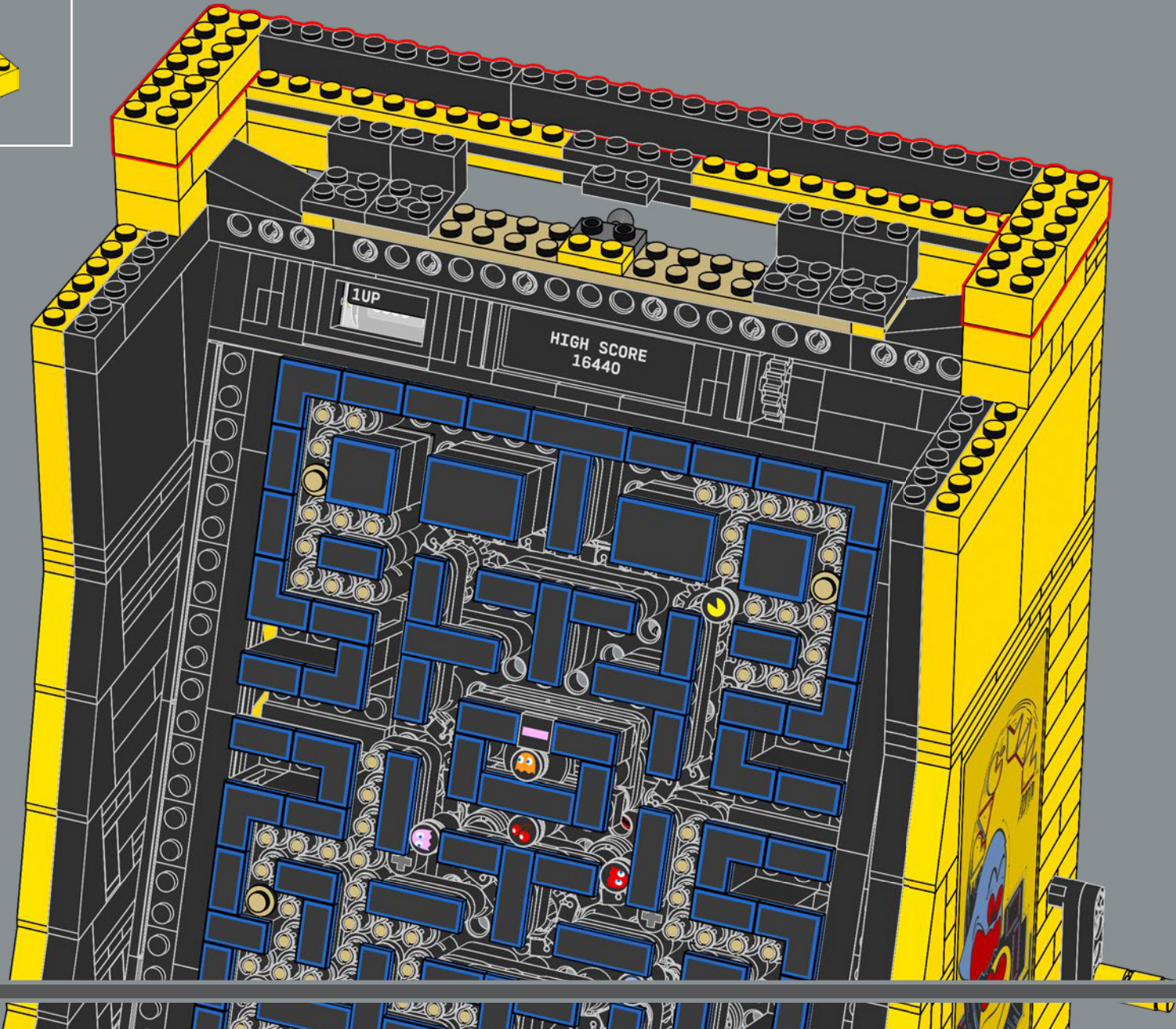



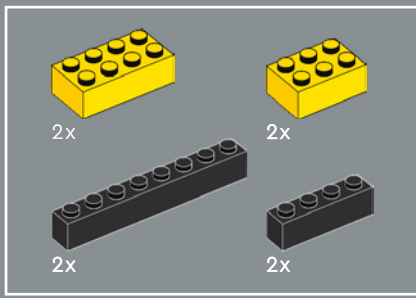

273

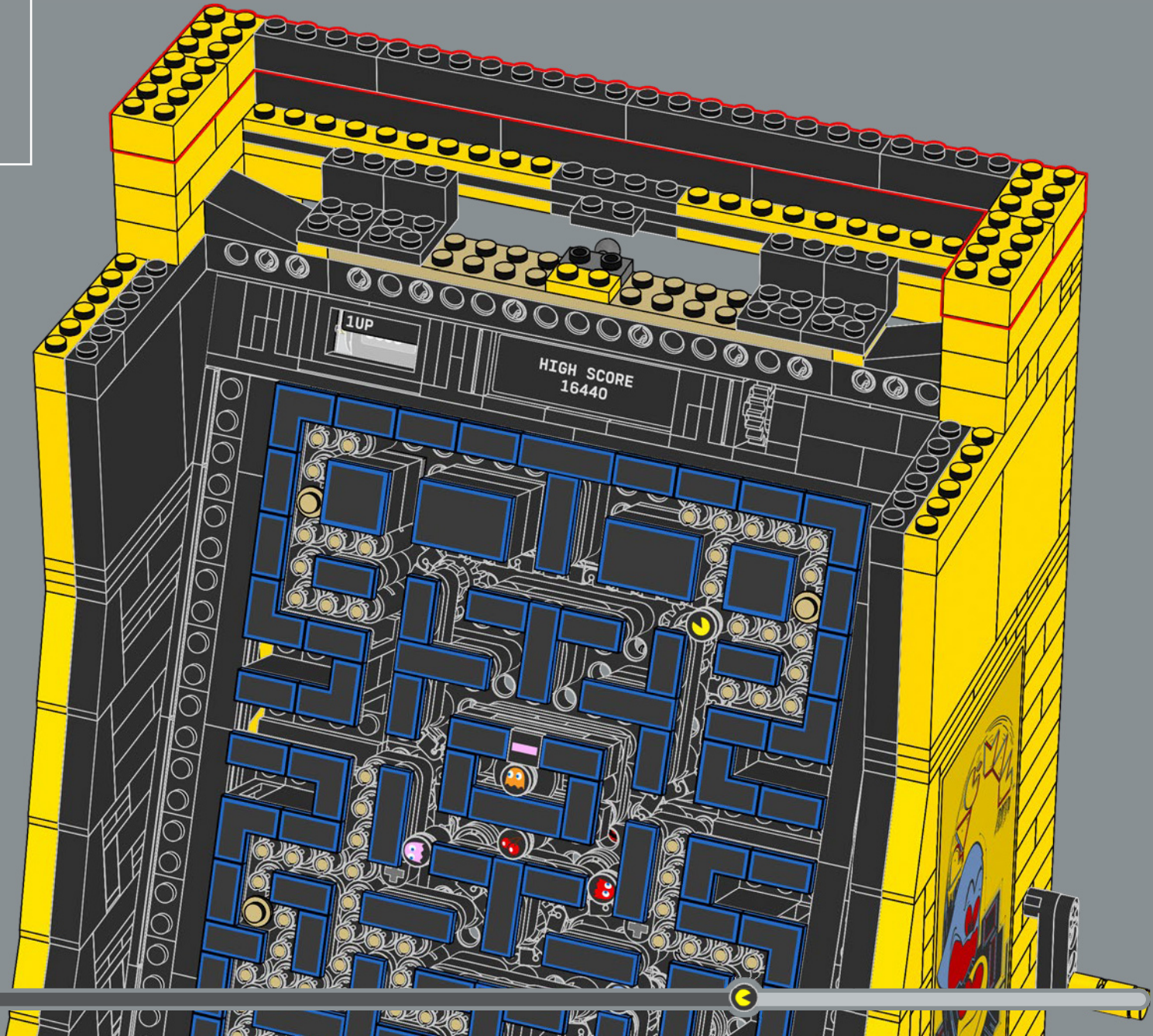

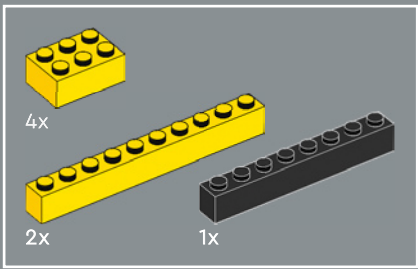

274

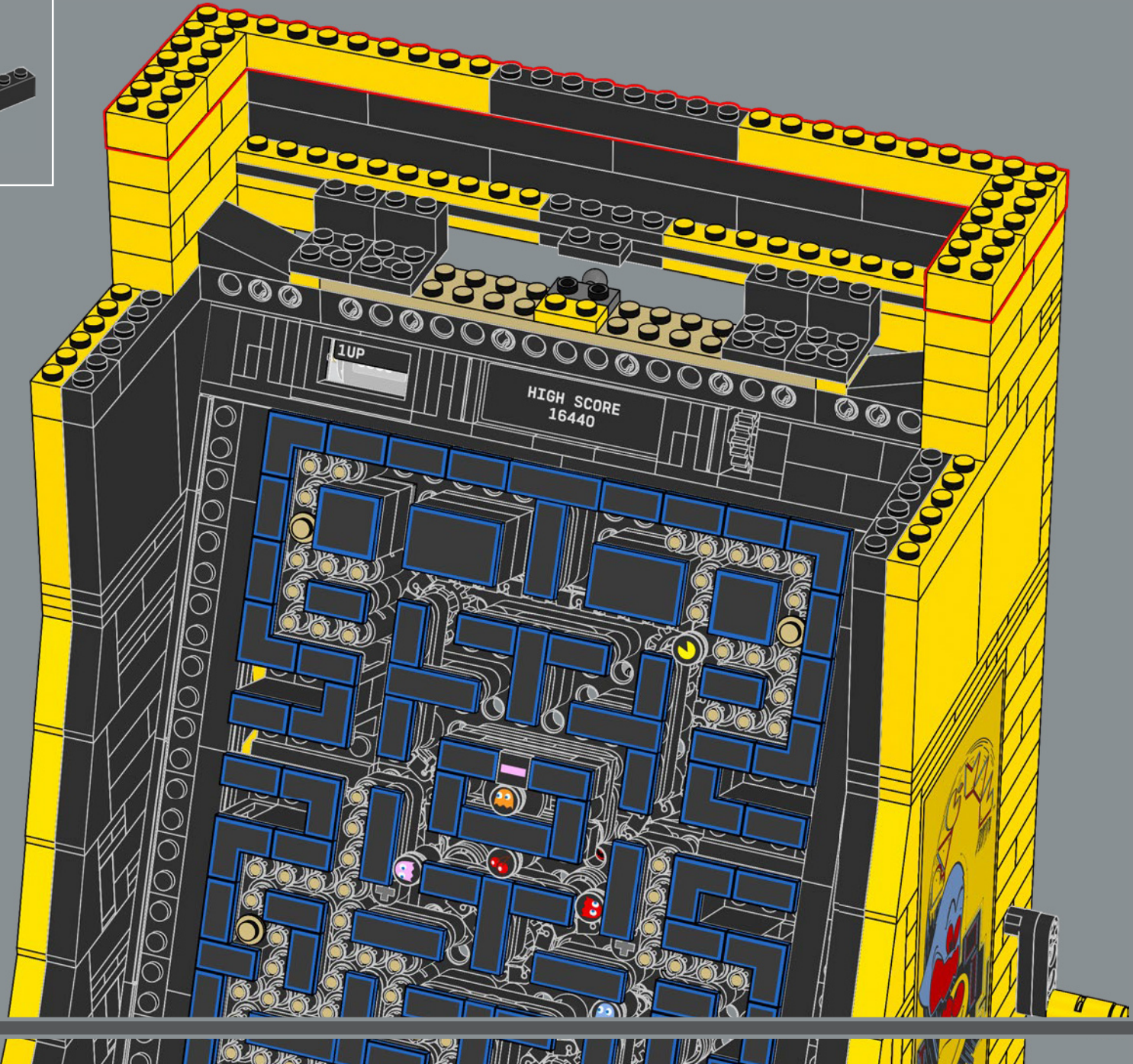

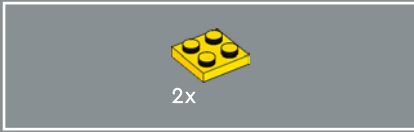
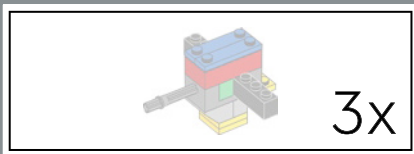

275

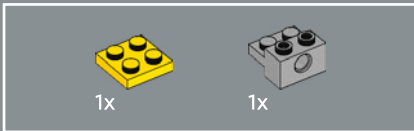
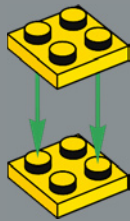

276

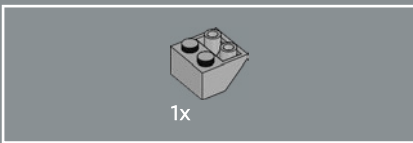
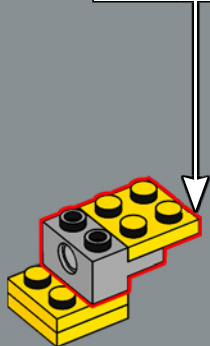
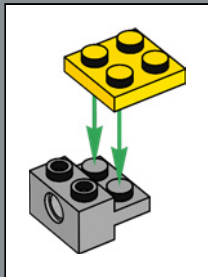

277

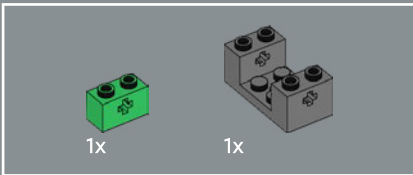
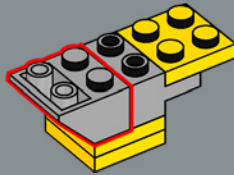

278

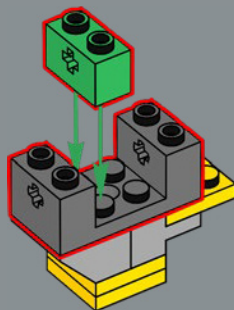

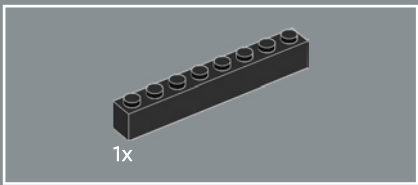

1x

279

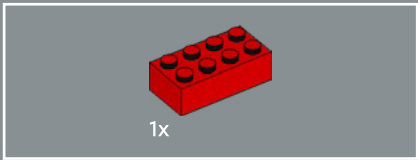
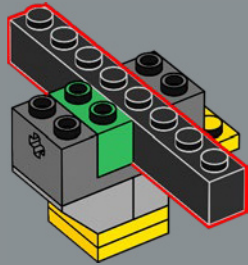

1x

280

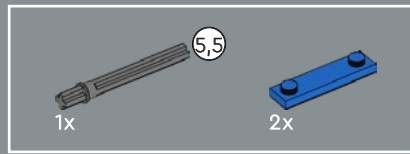
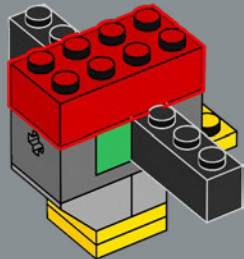

1x

2x

281

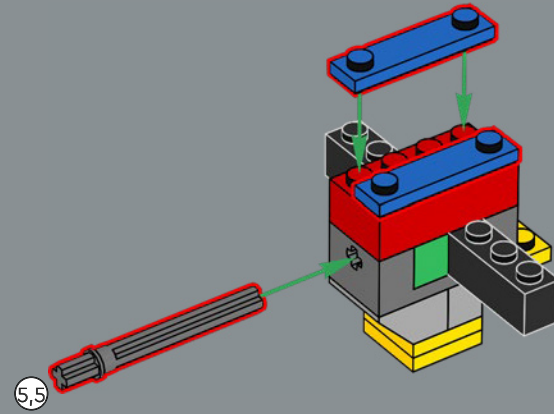

3x

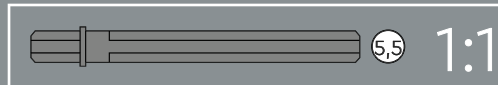

55

1:1

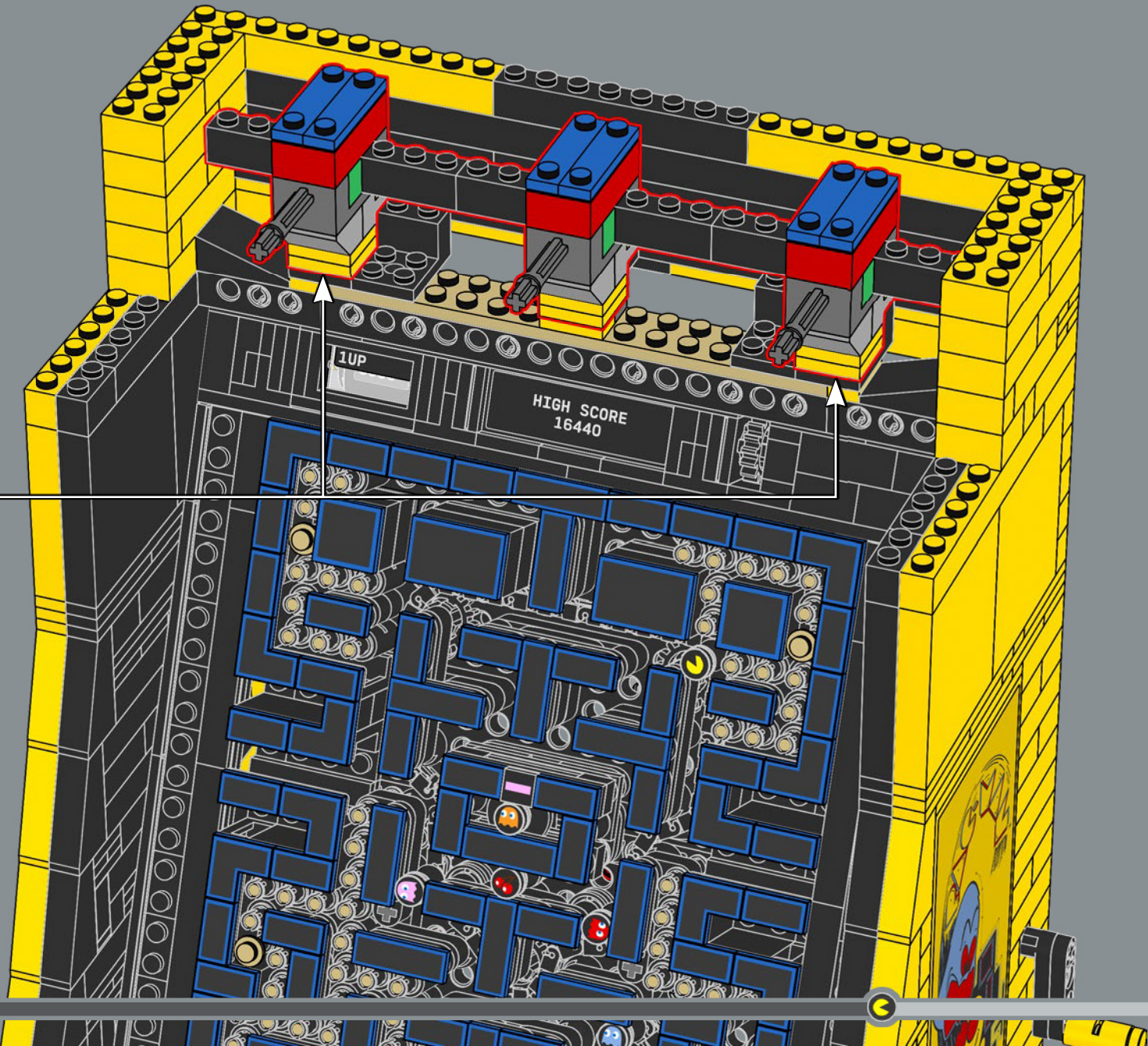

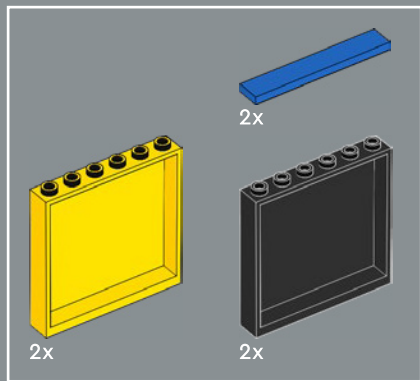

283

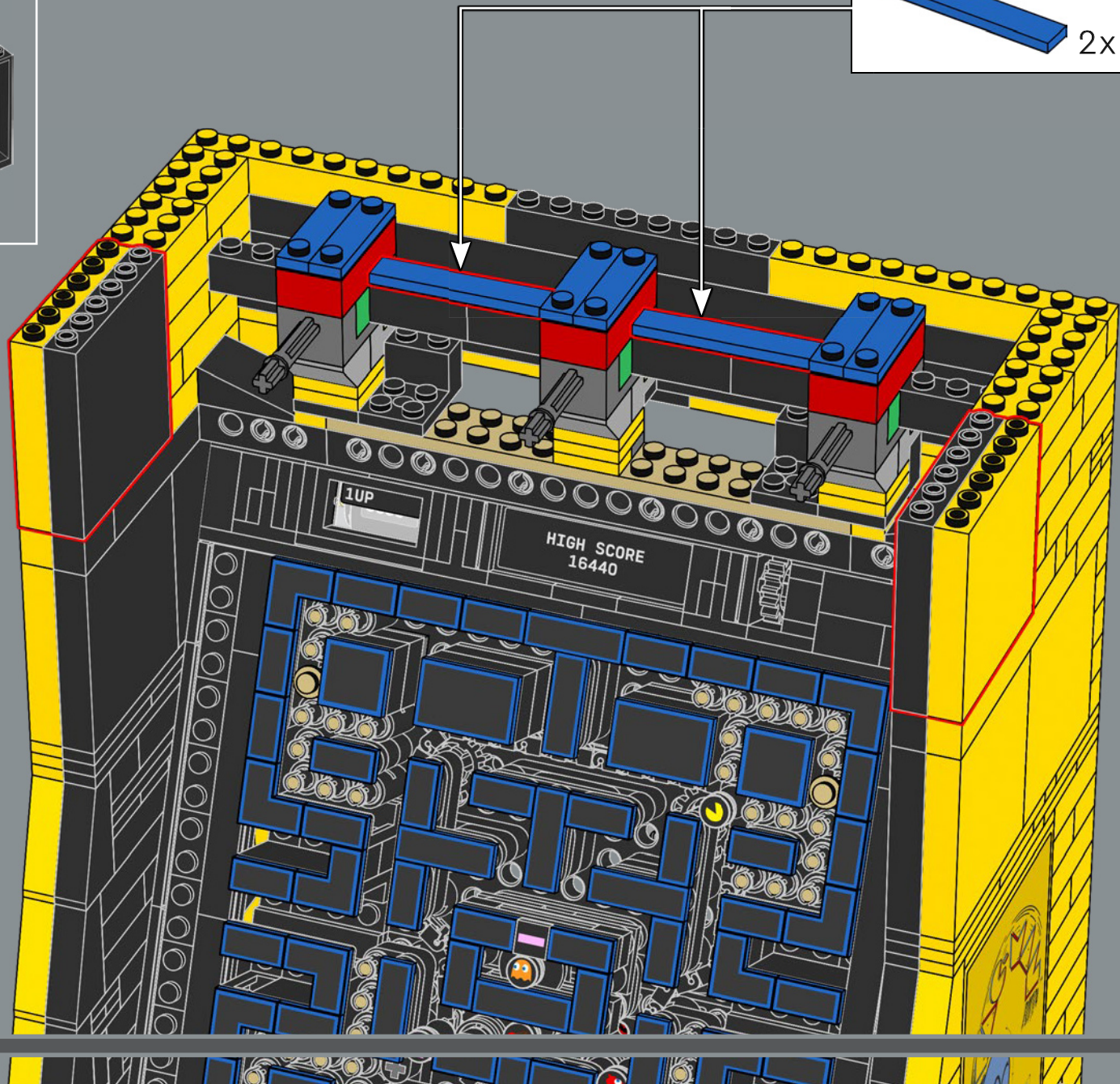
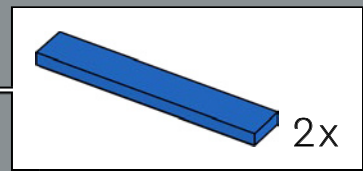

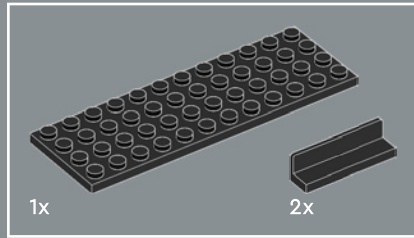
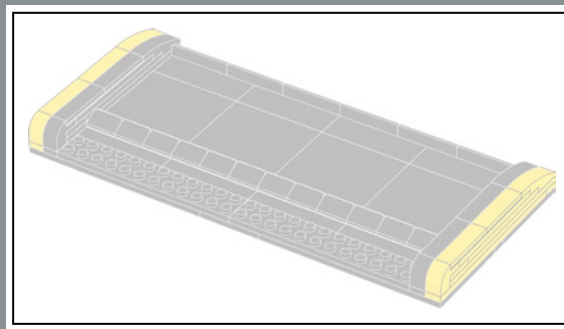

284

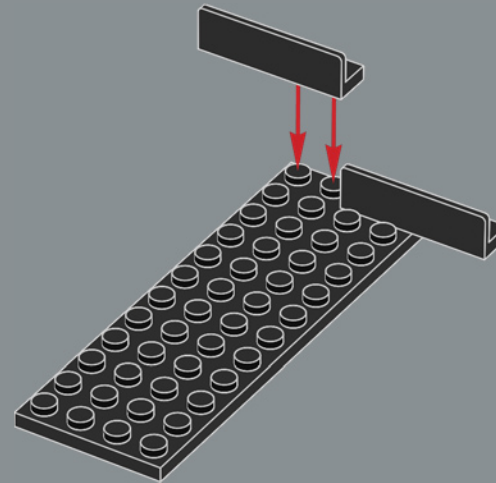

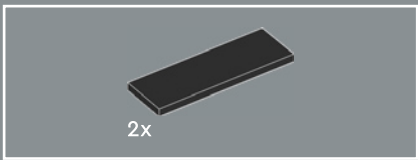

285

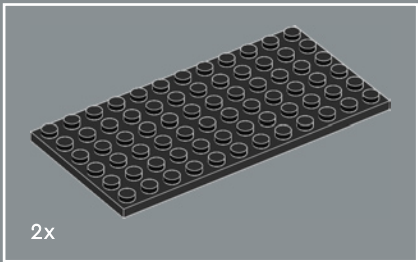
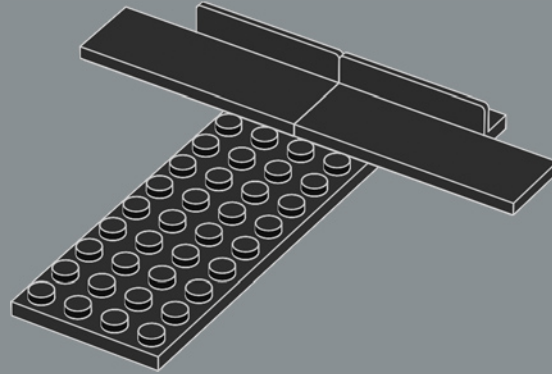

286

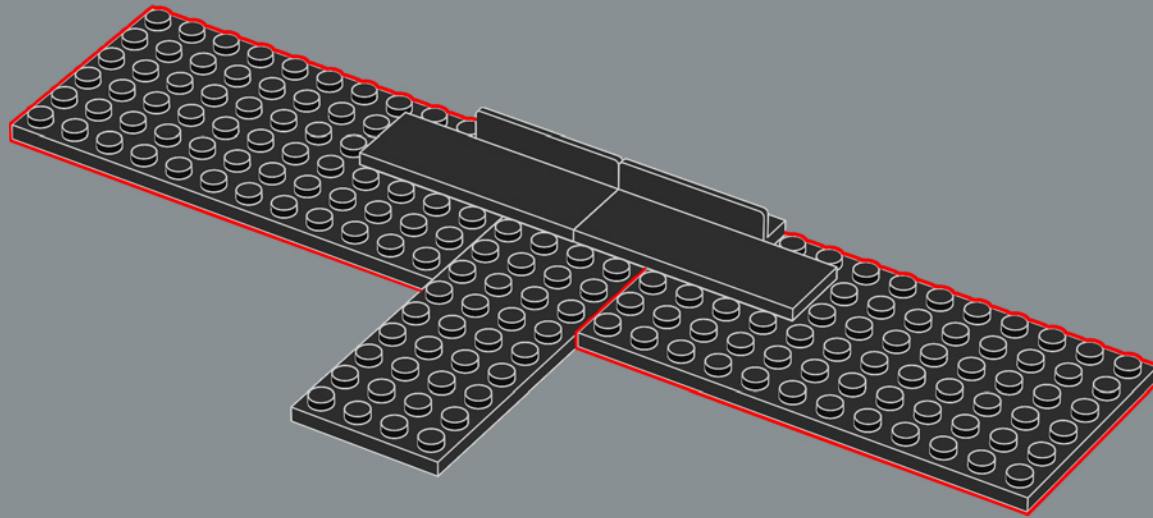



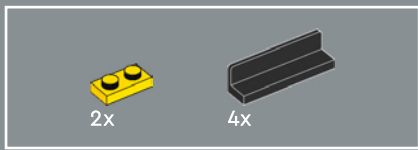

287

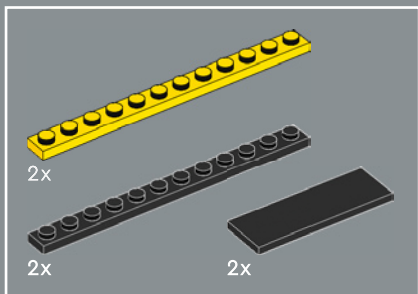
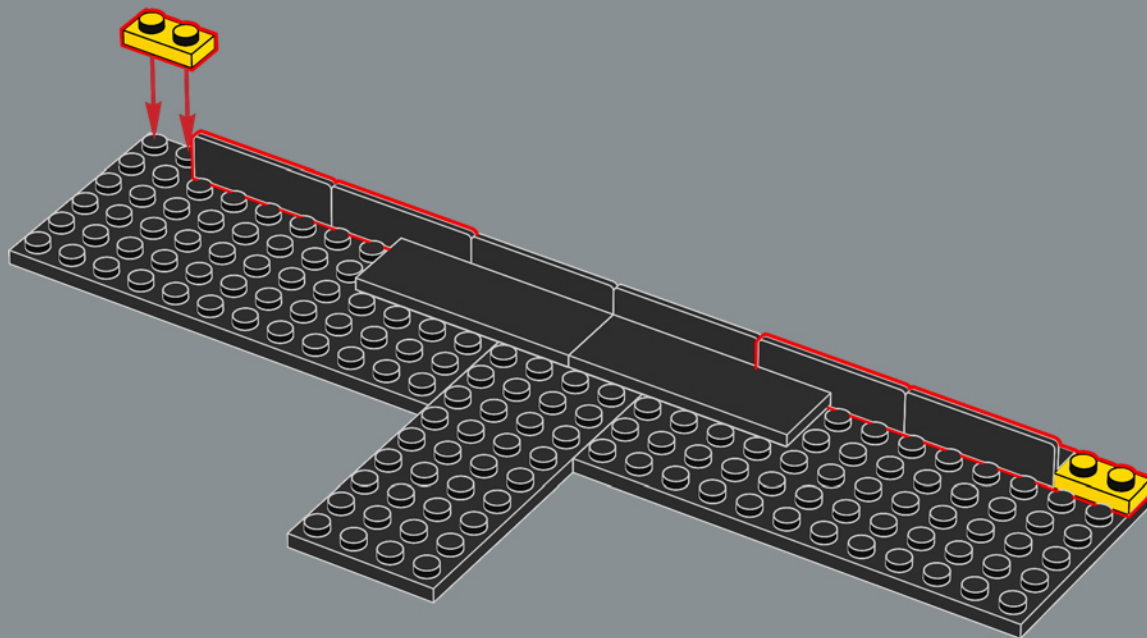

288

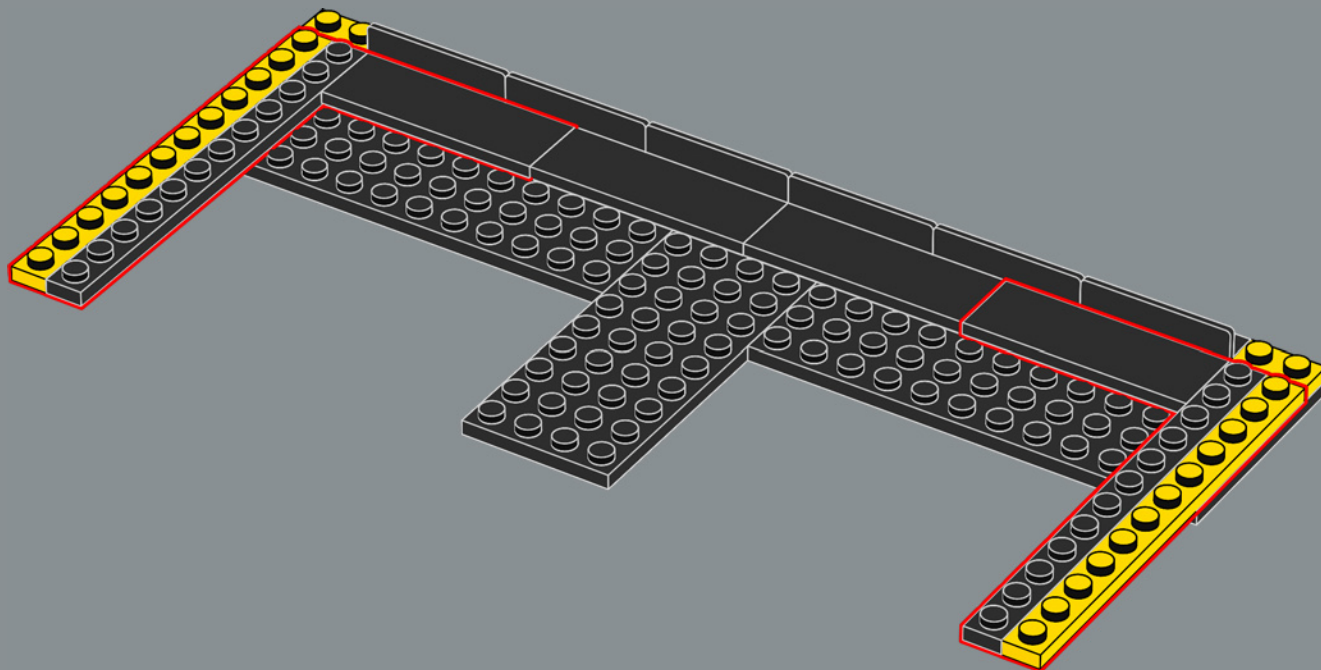

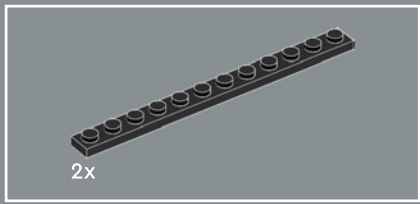

289

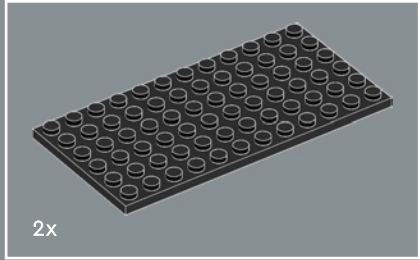
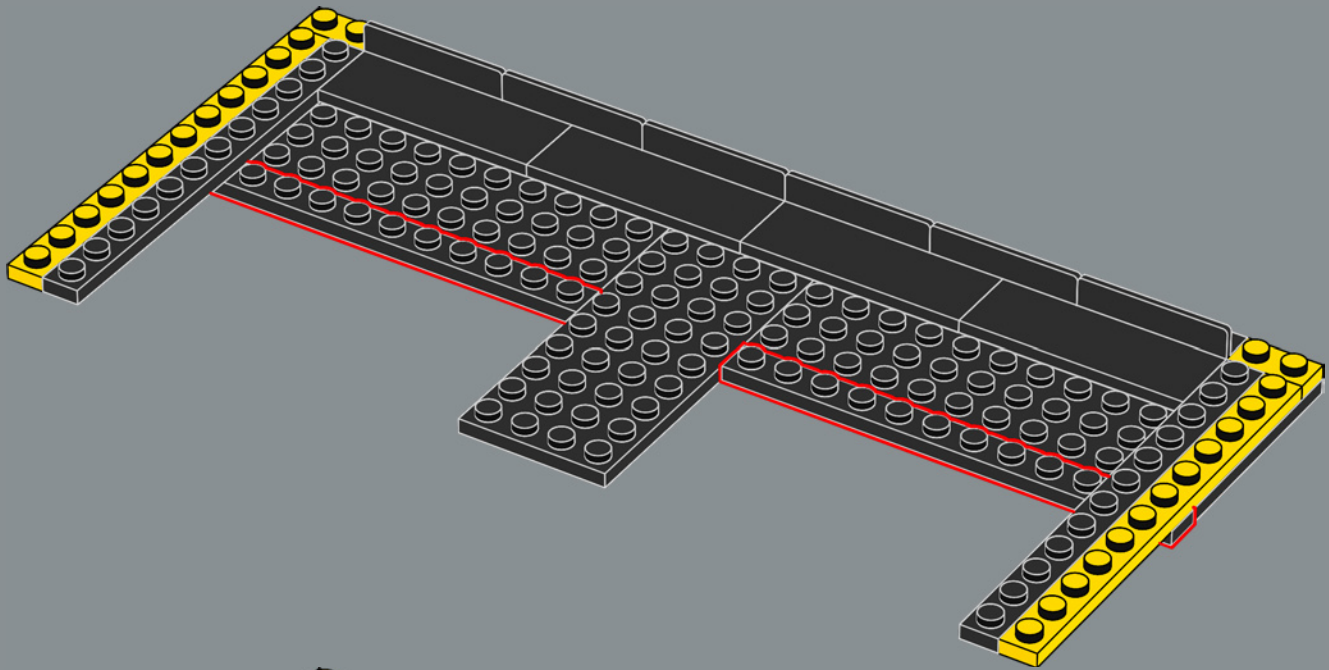

290

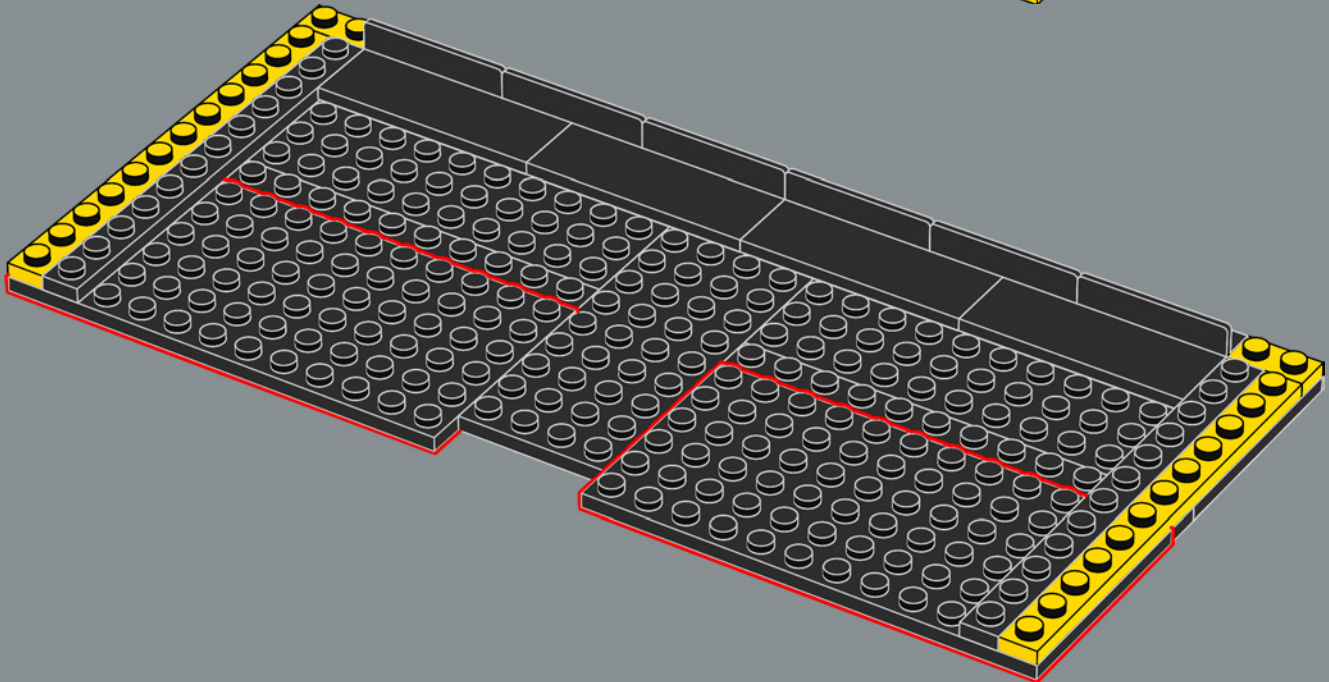

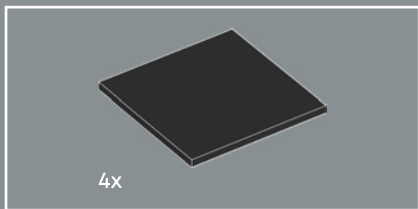

291

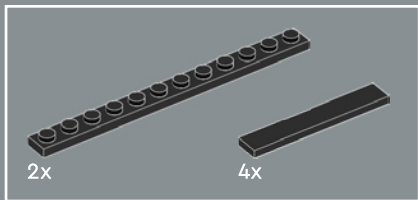
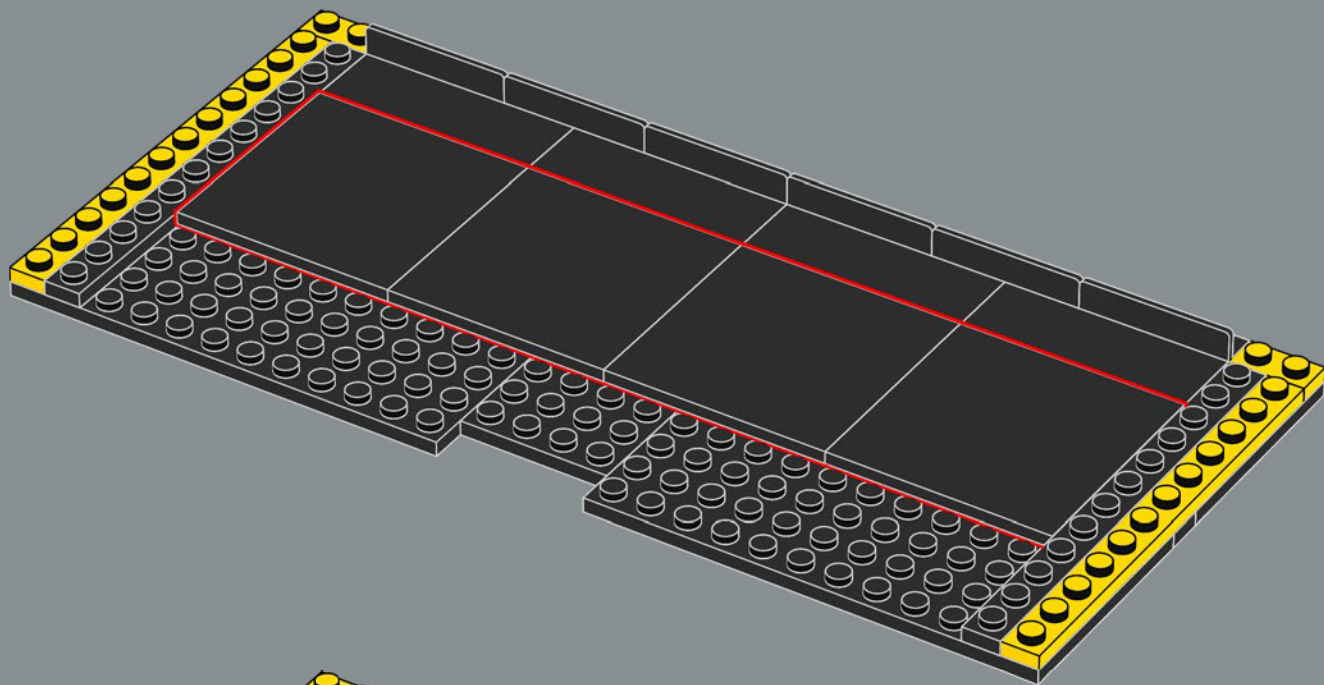

292

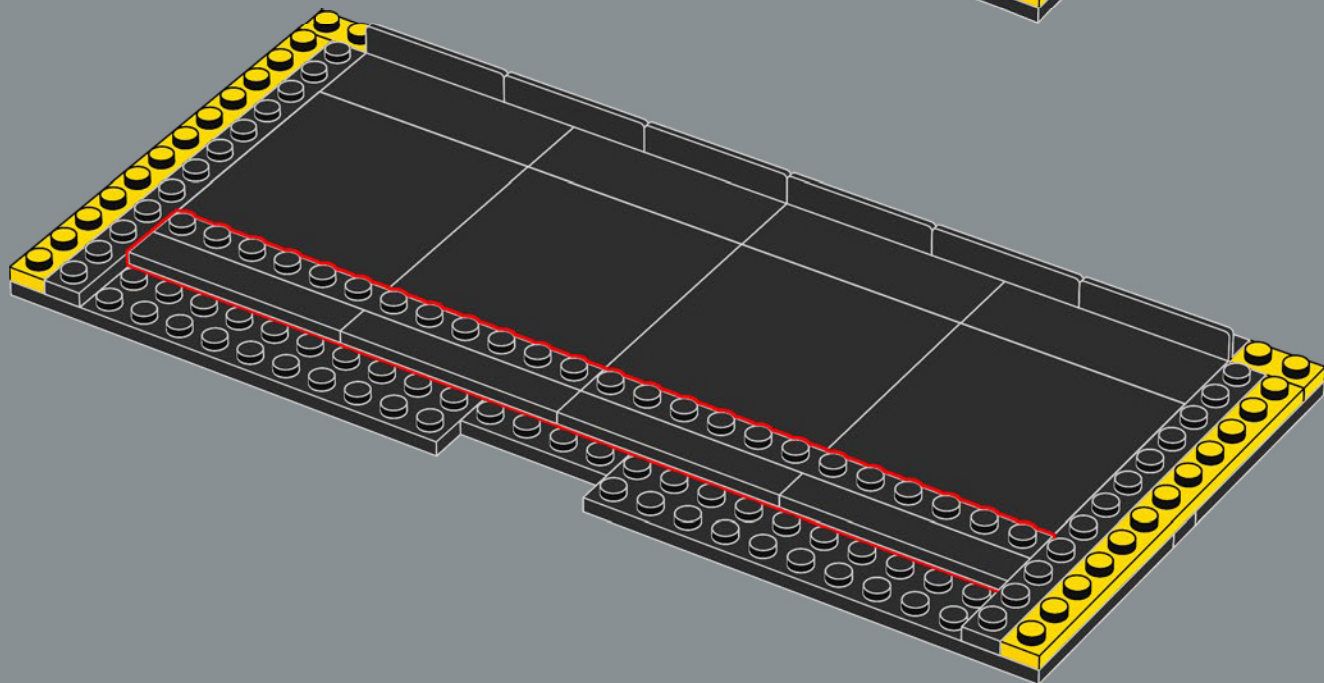

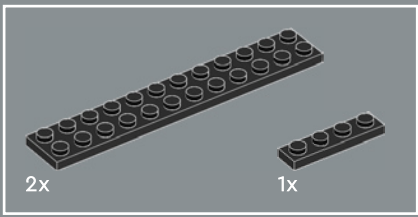

293

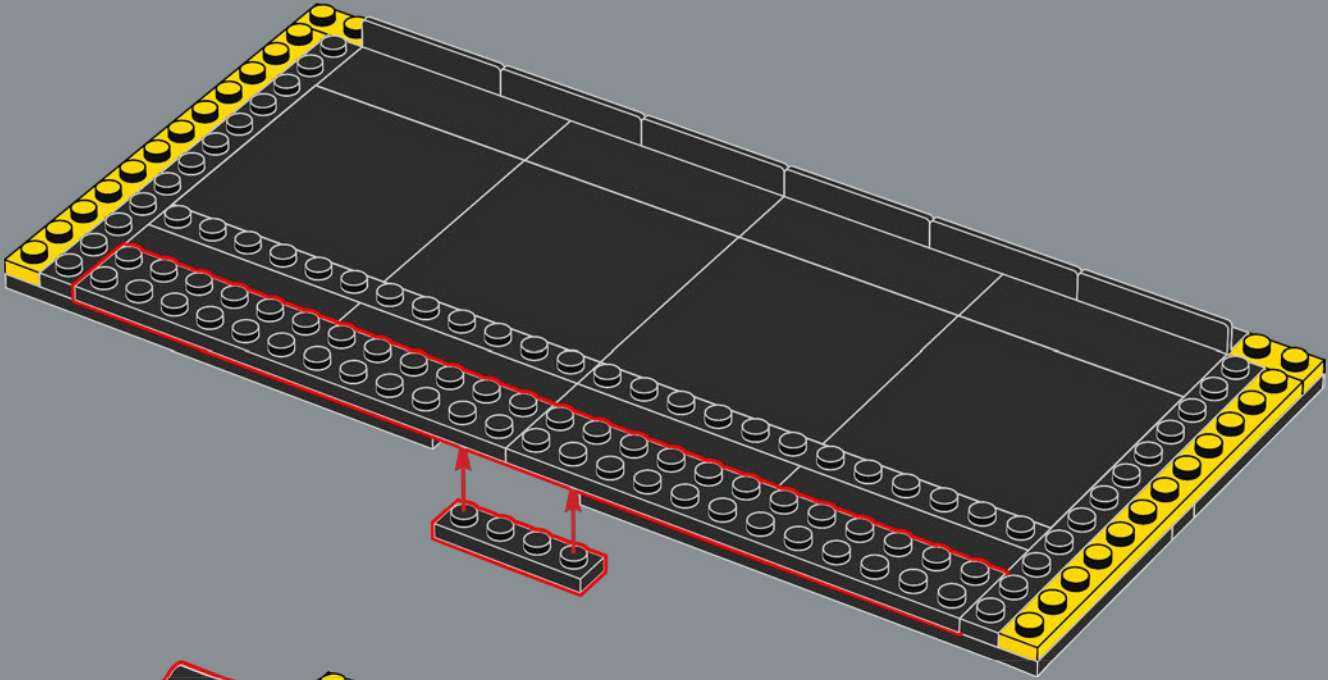

294

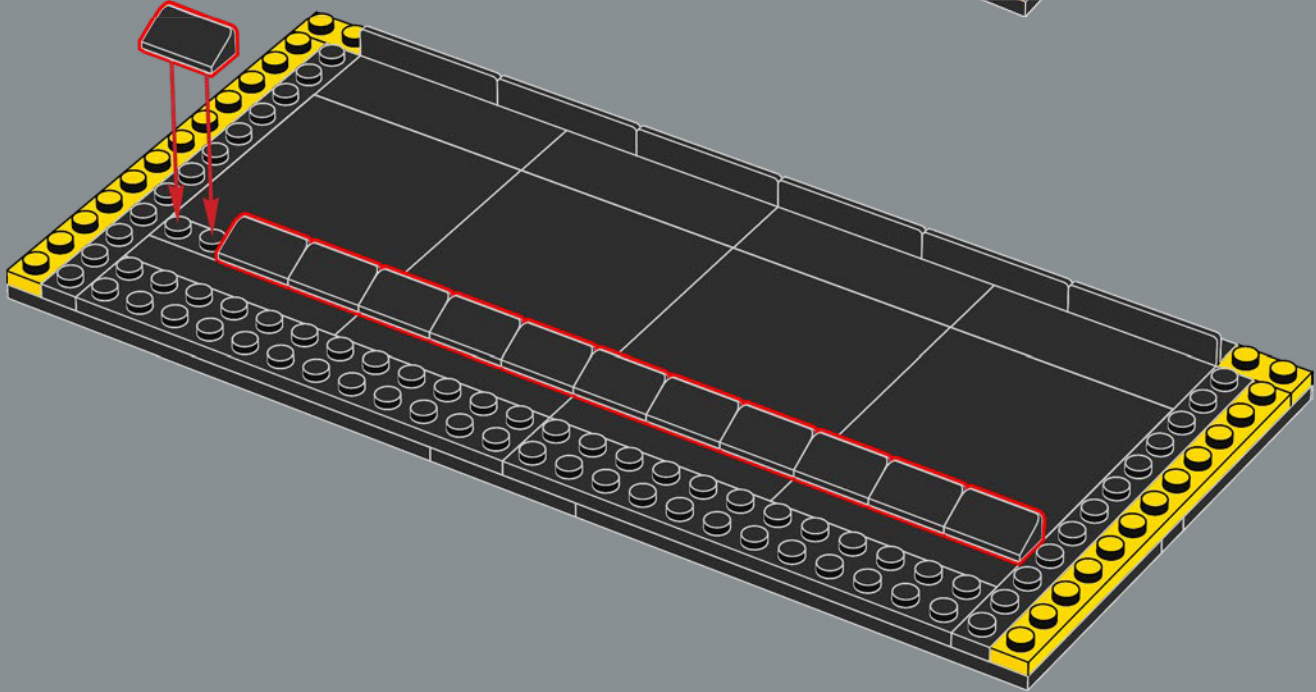

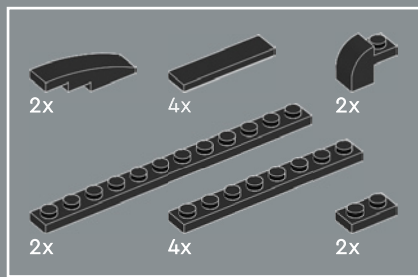

295

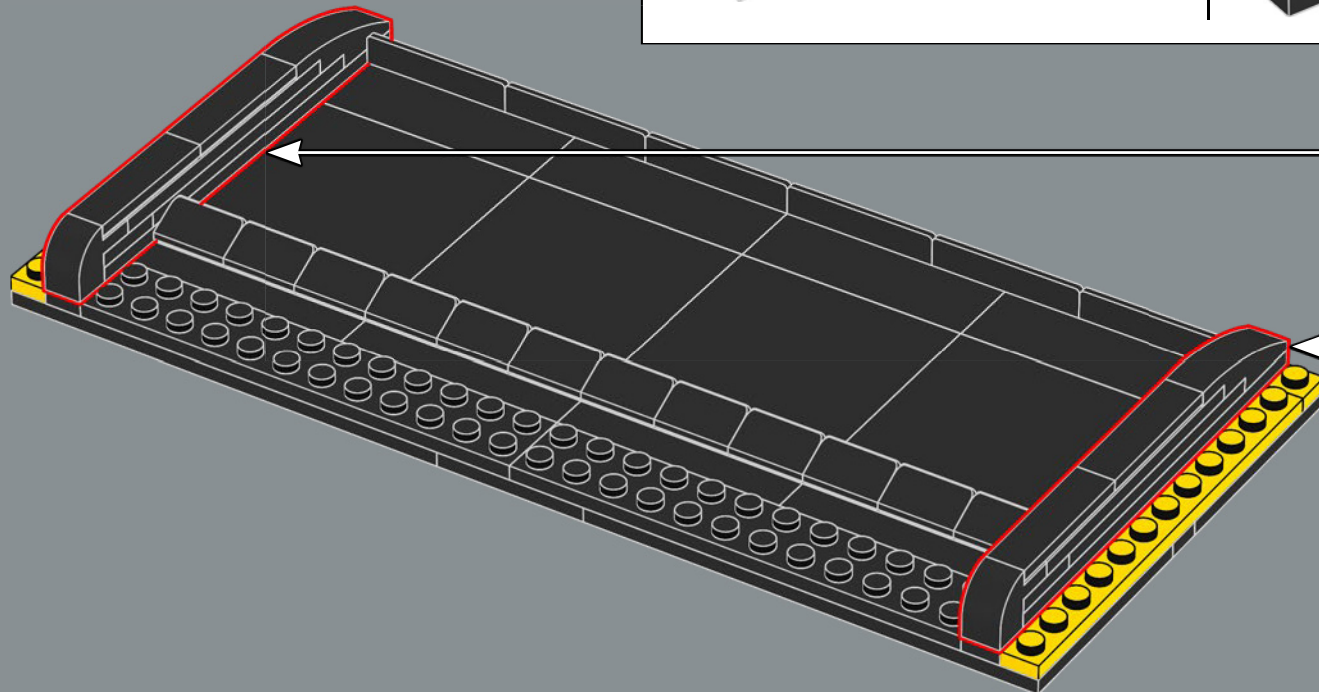
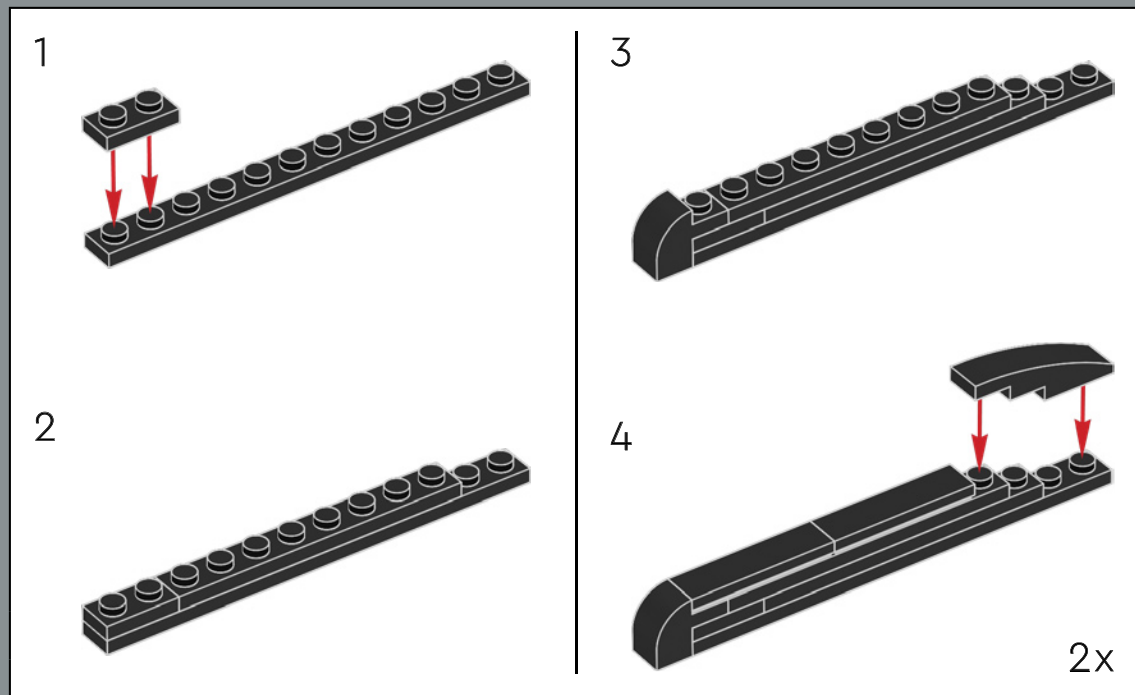

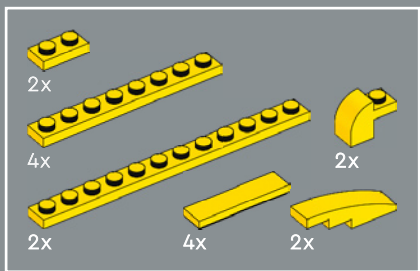

296

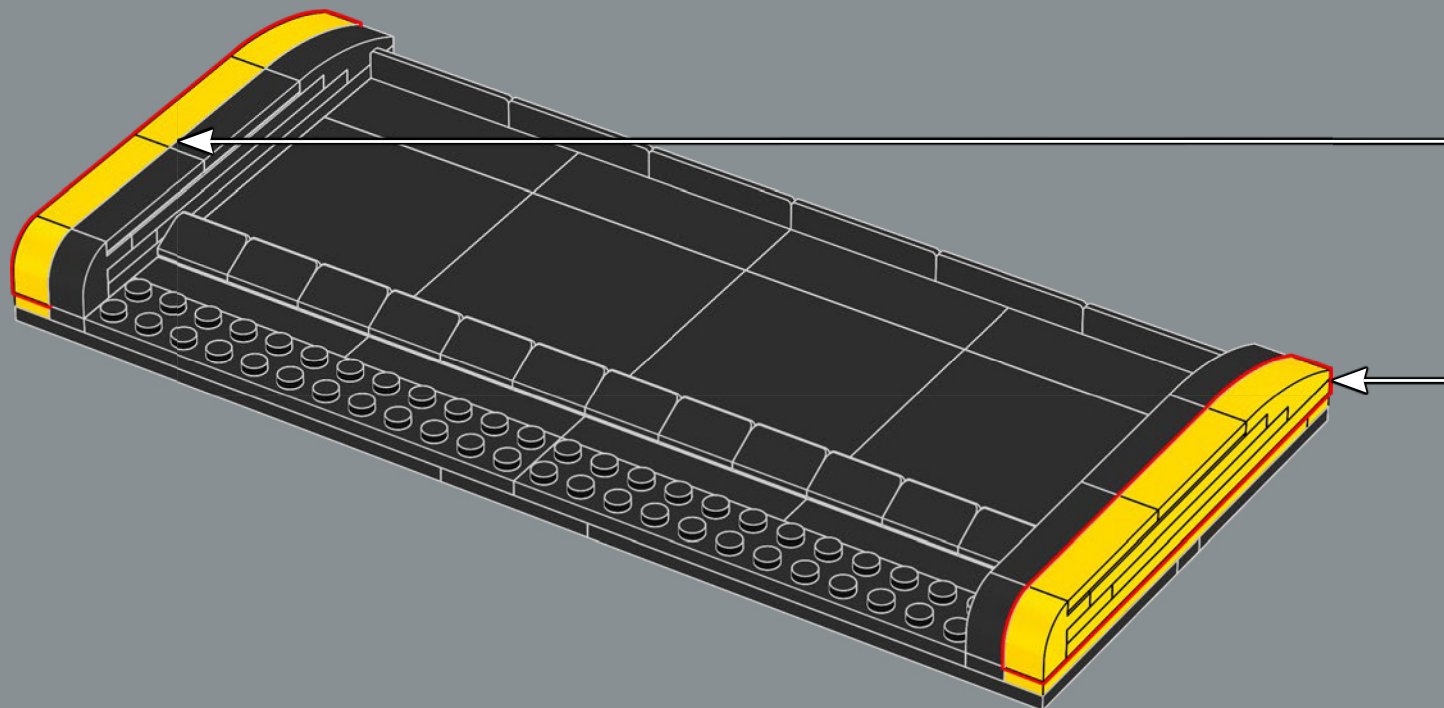
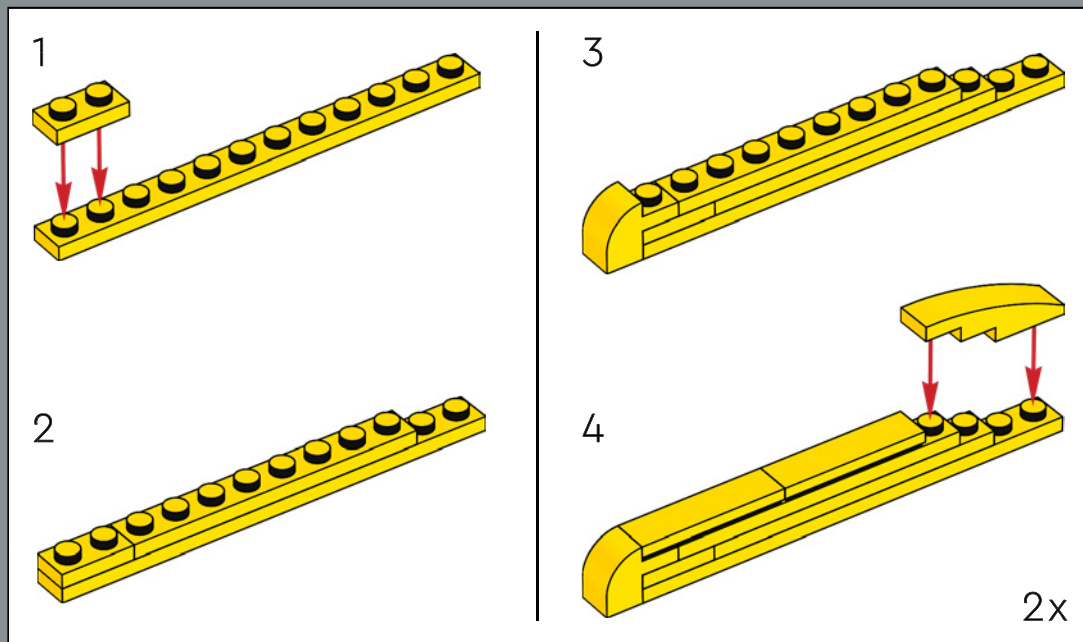

297

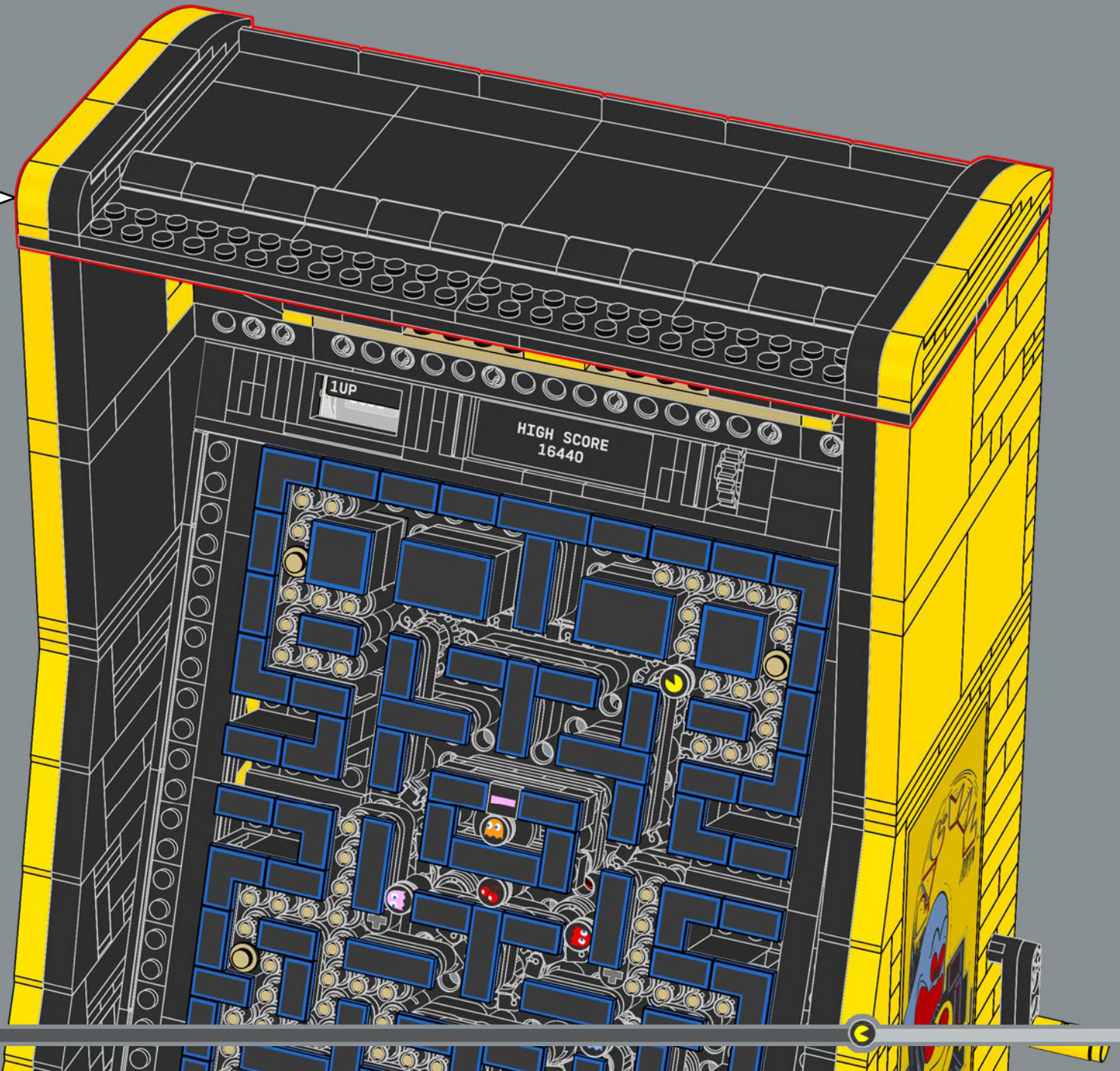

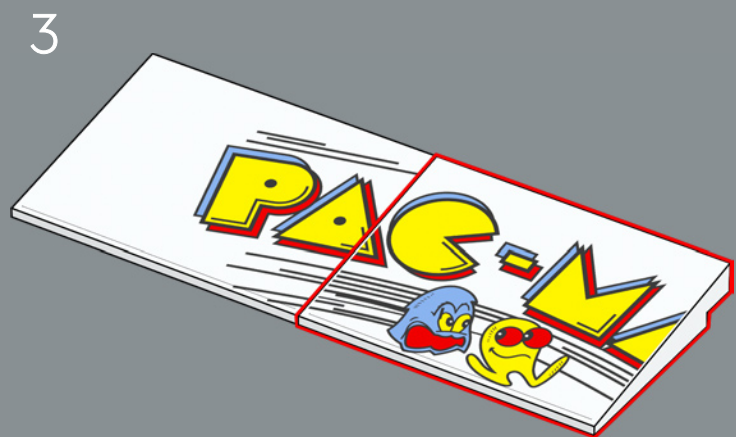
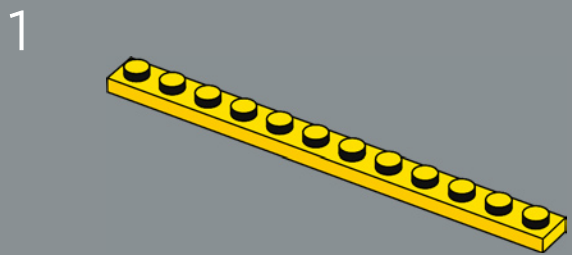
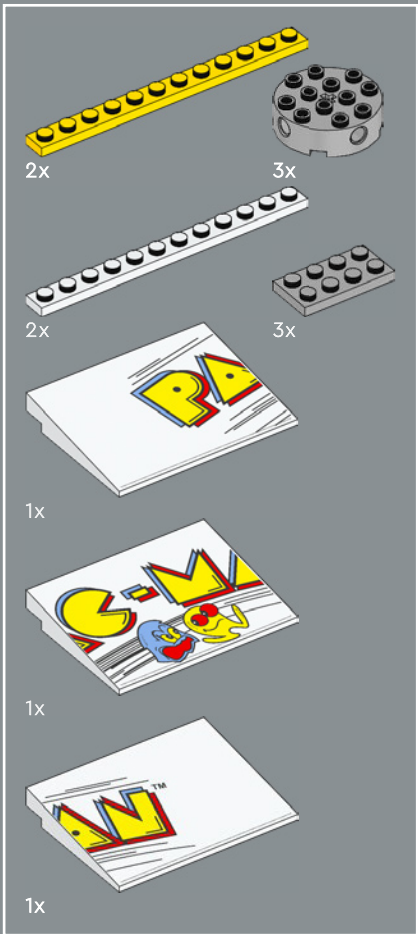
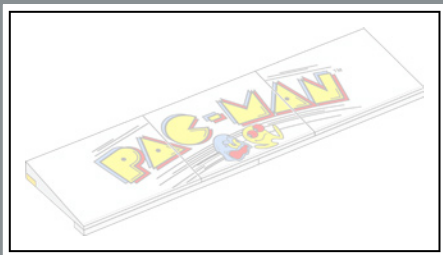



4

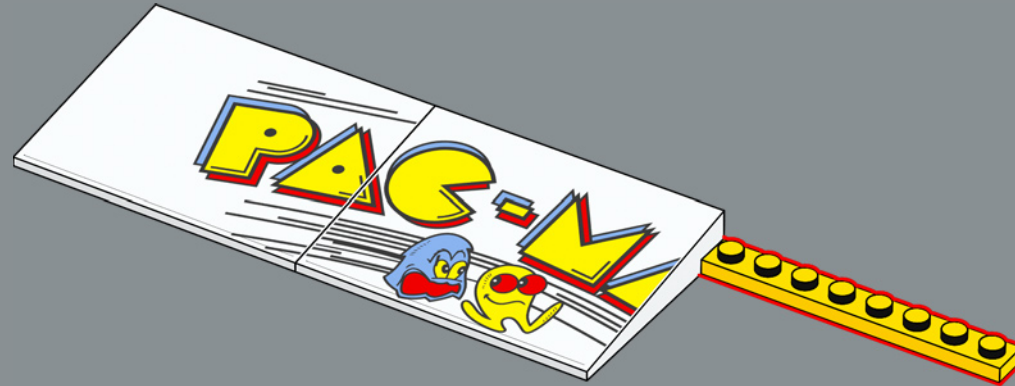

The world record for the fastest time with a perfect score is 3 hours, 28 minutes and 49 seconds.

Le record mondial du meilleur temps avec un score parfait est de 3 heures, 28 minutes et 49 secondes.

El récord mundial del menor tiempo con una puntuación perfecta es de 3 horas, 28 minutos y 49 segundos.

5

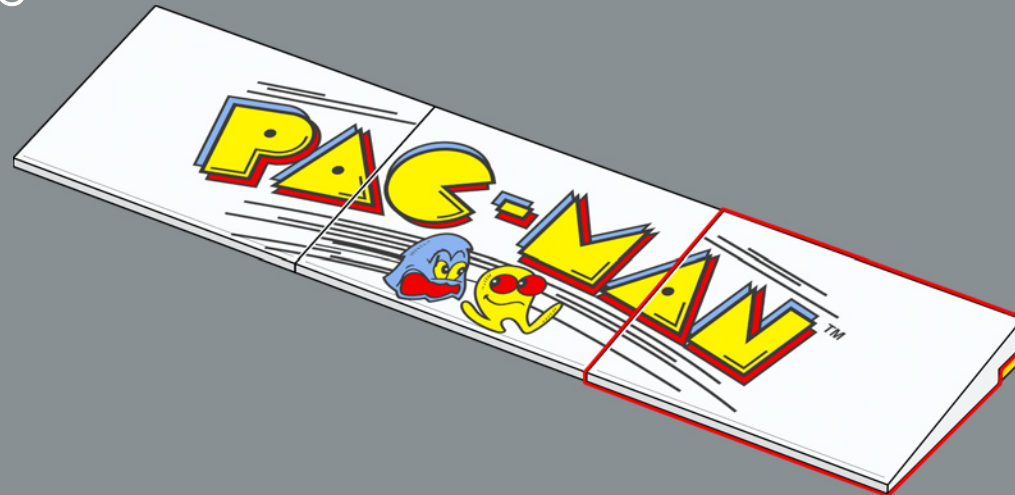



6

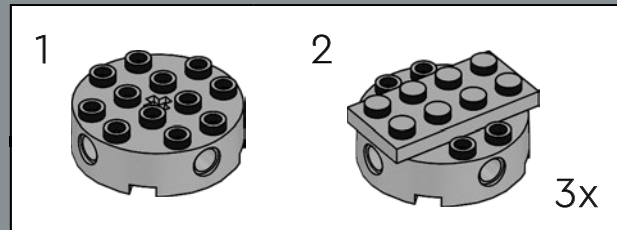
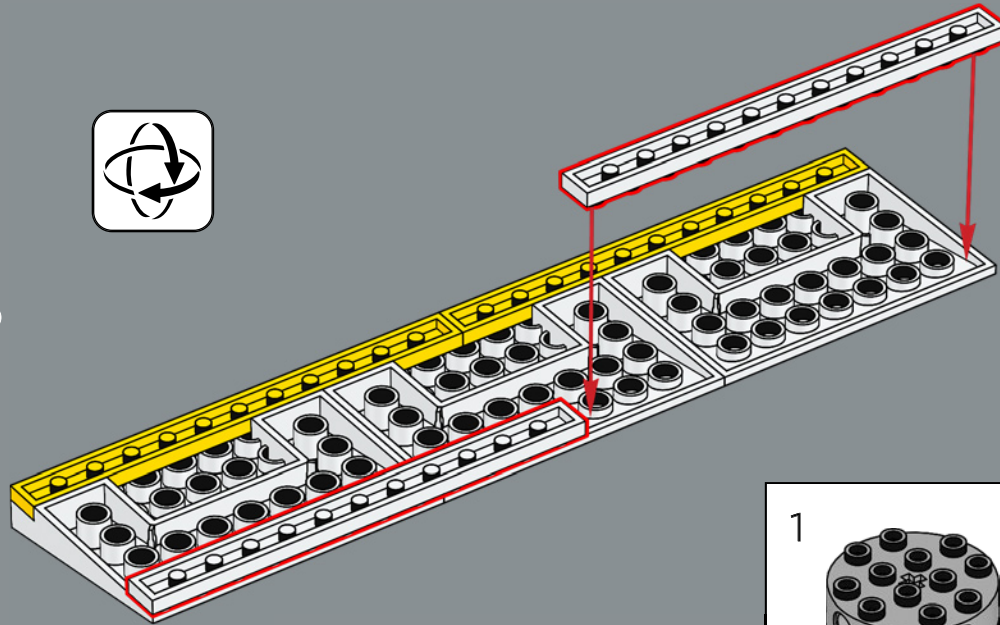

7

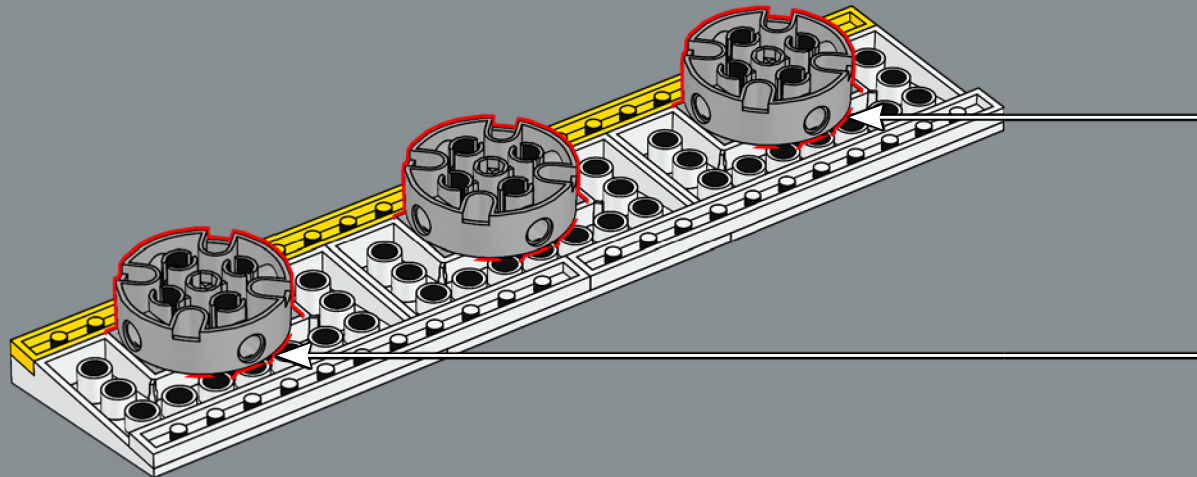

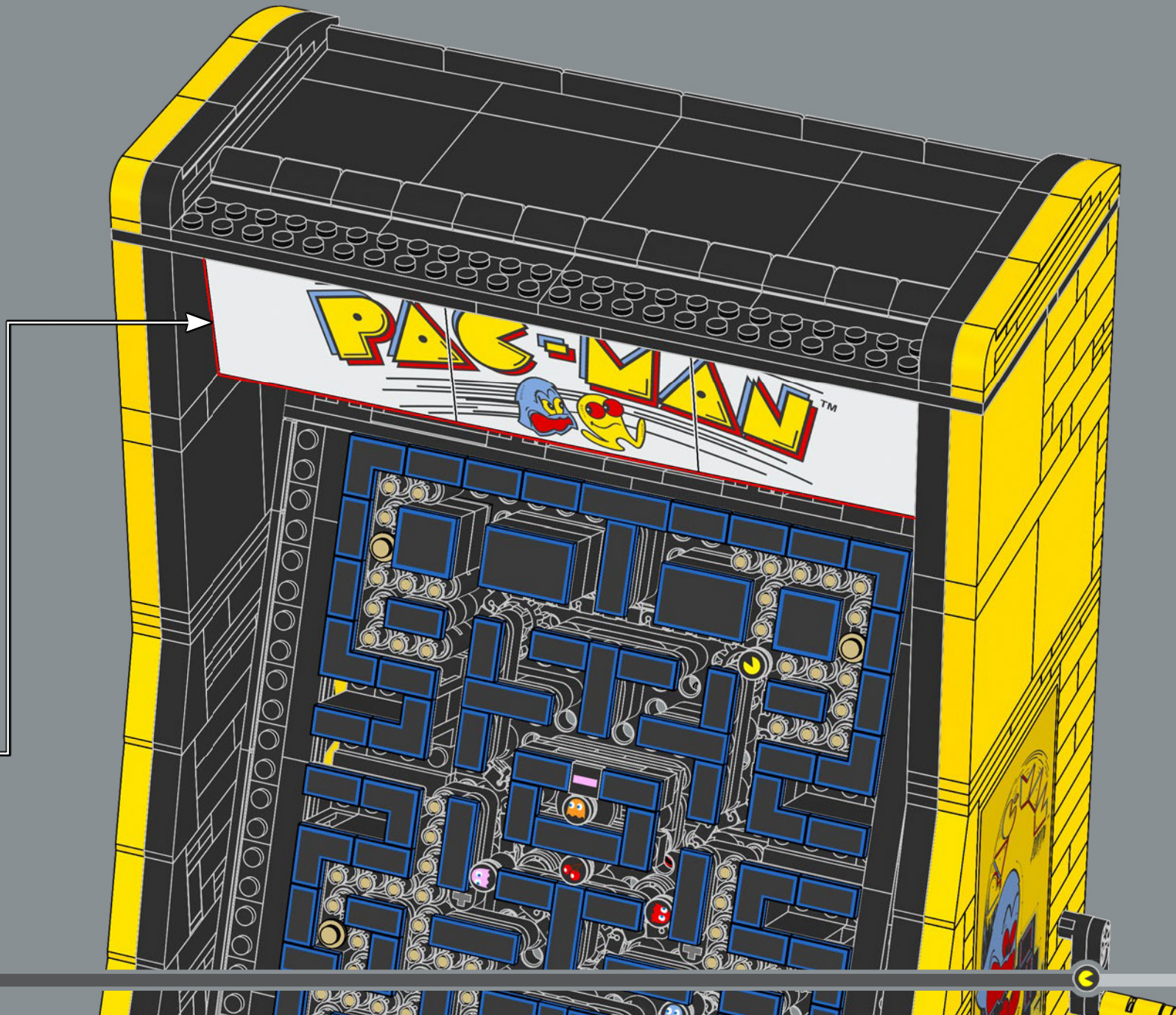

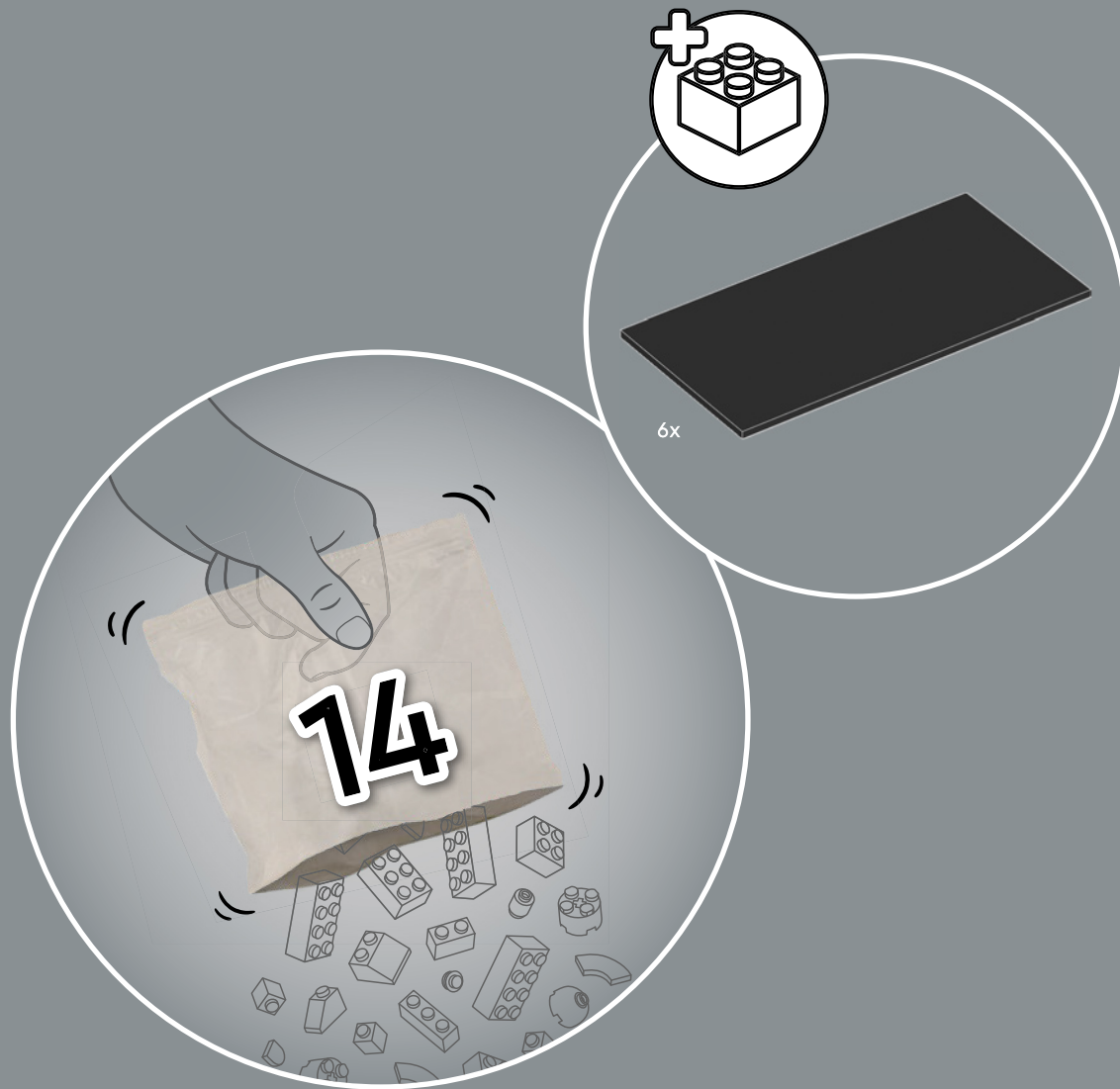

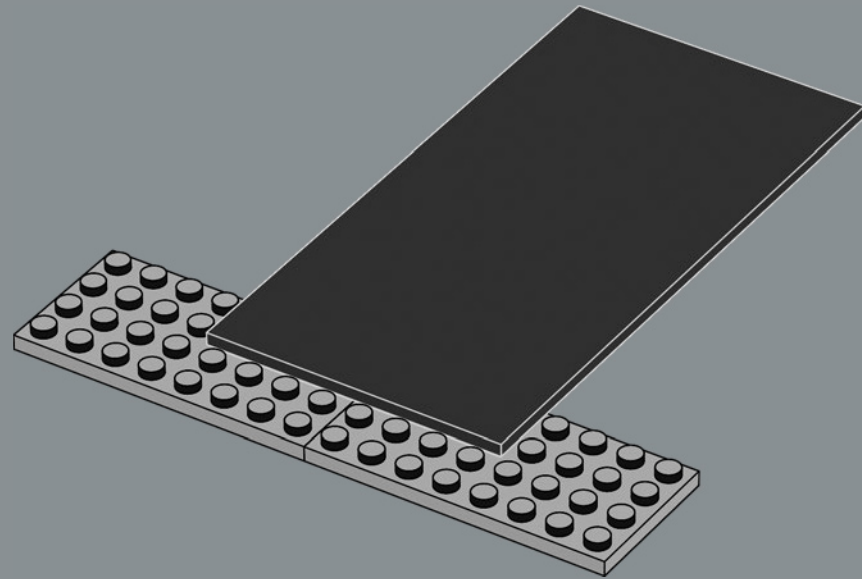
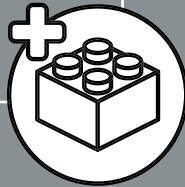
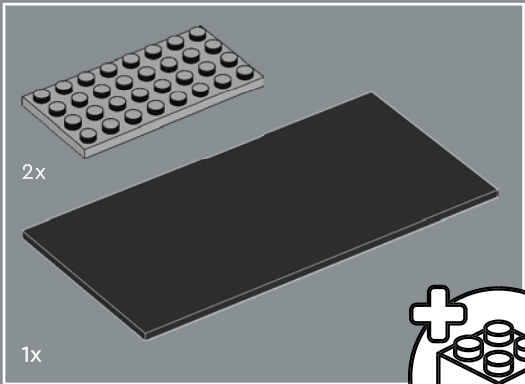
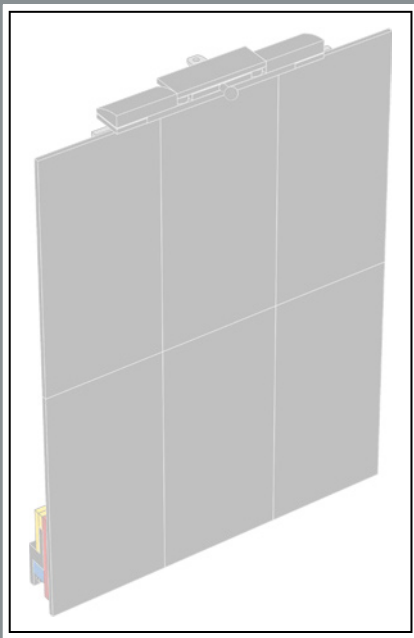

299

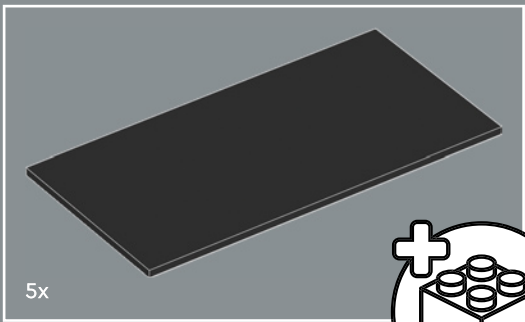

5x

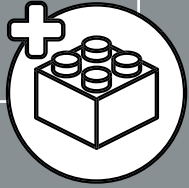

300

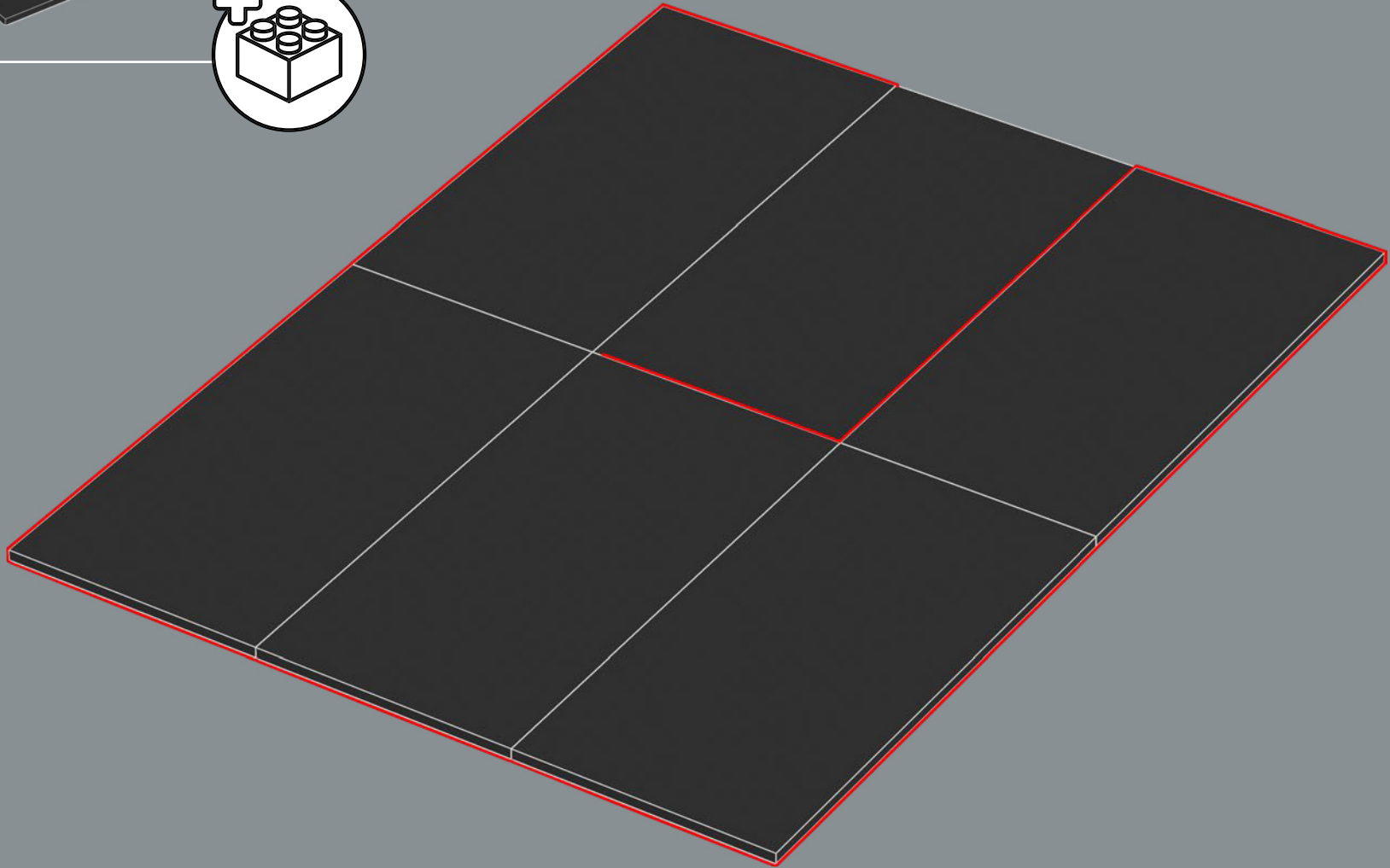

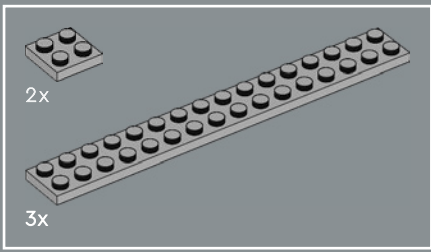

301

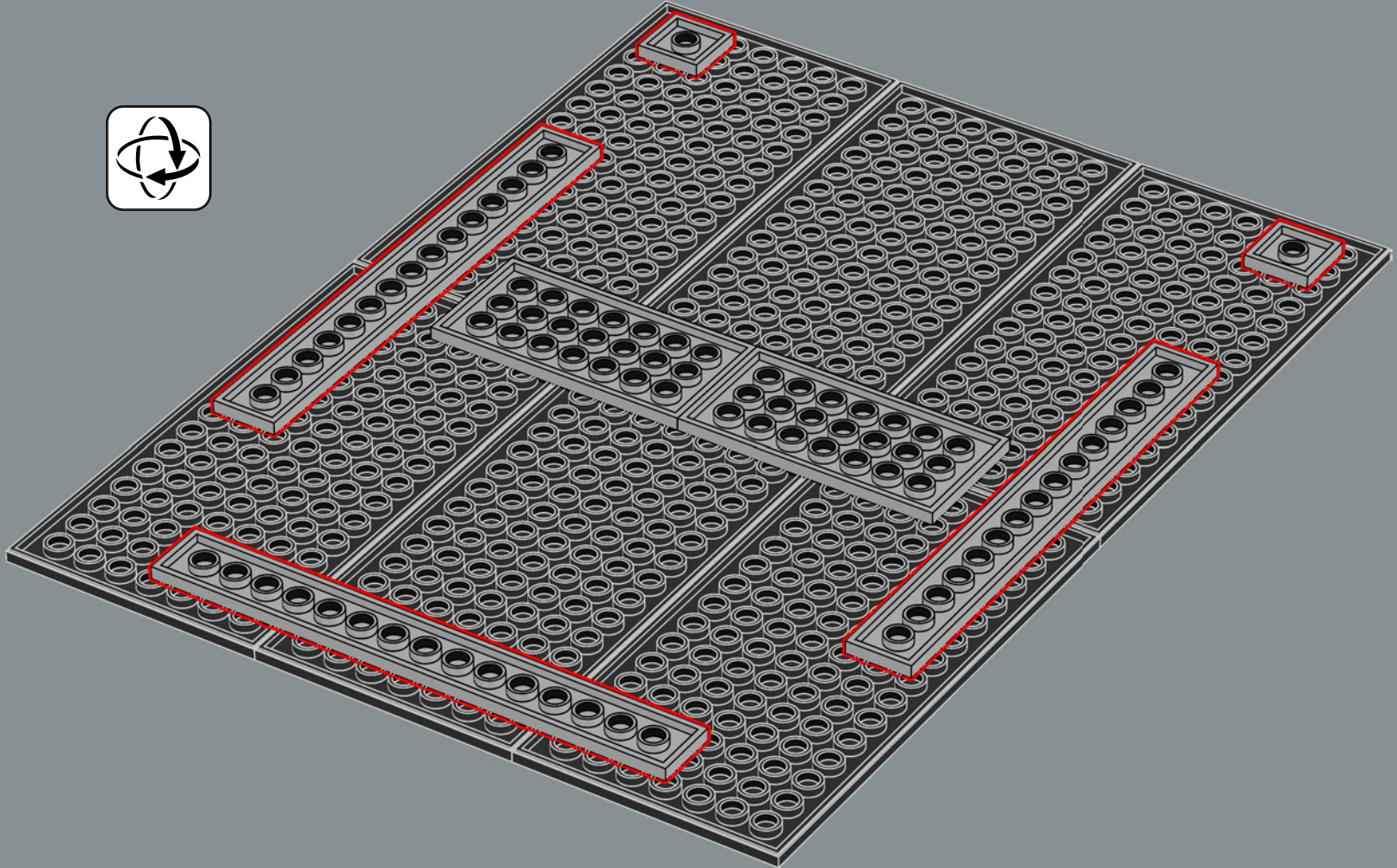

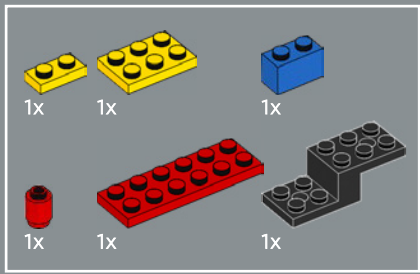

302

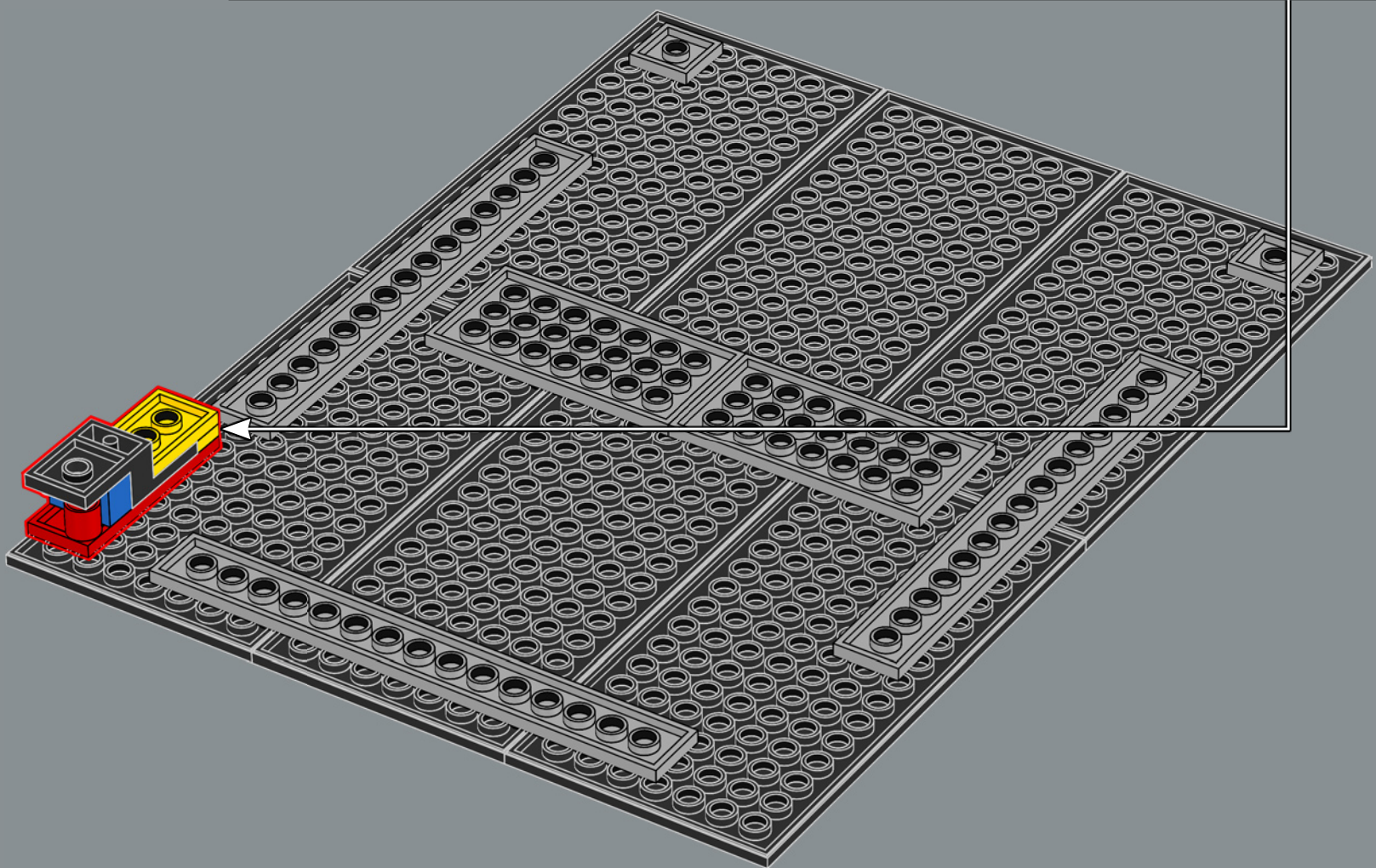
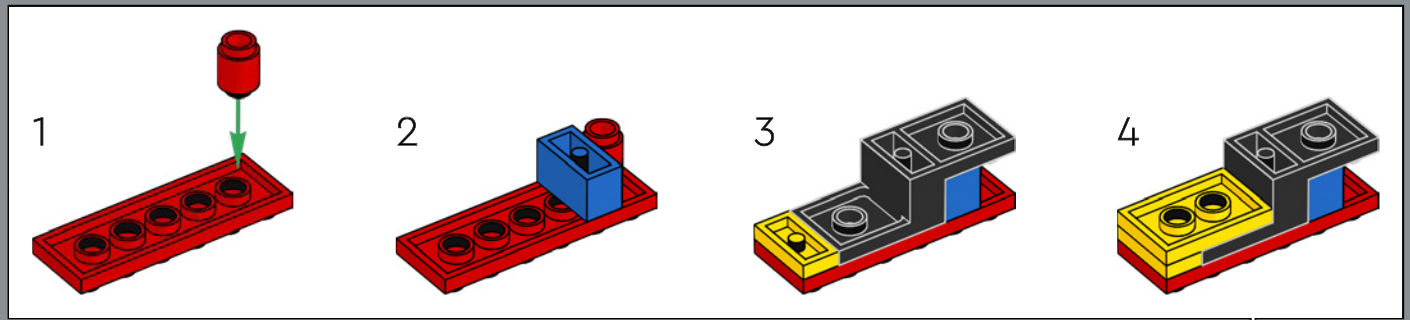



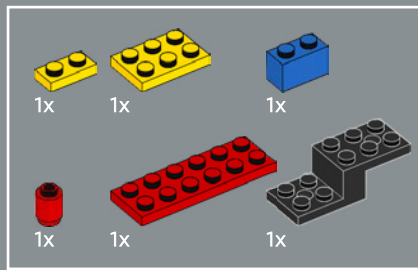

303

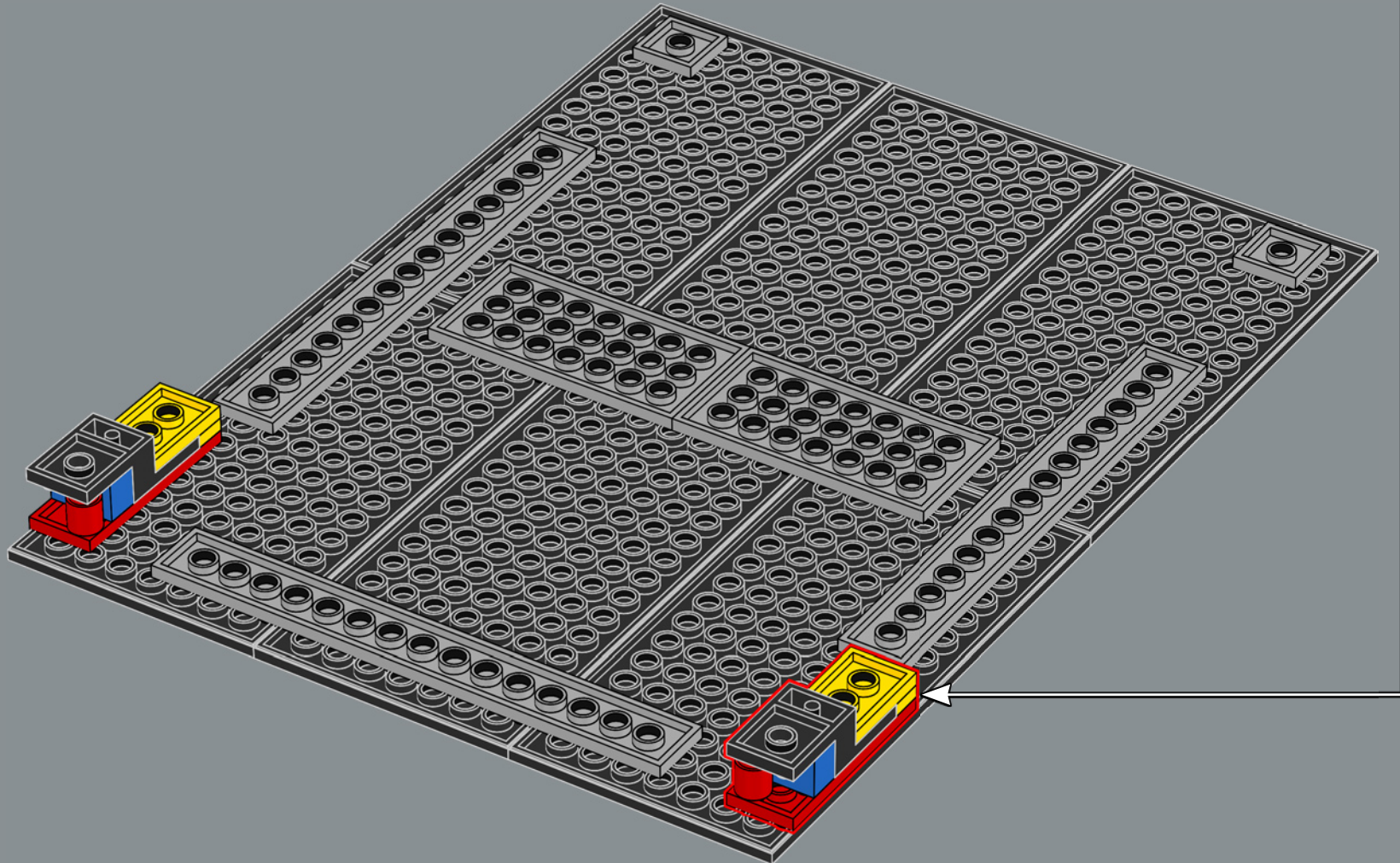
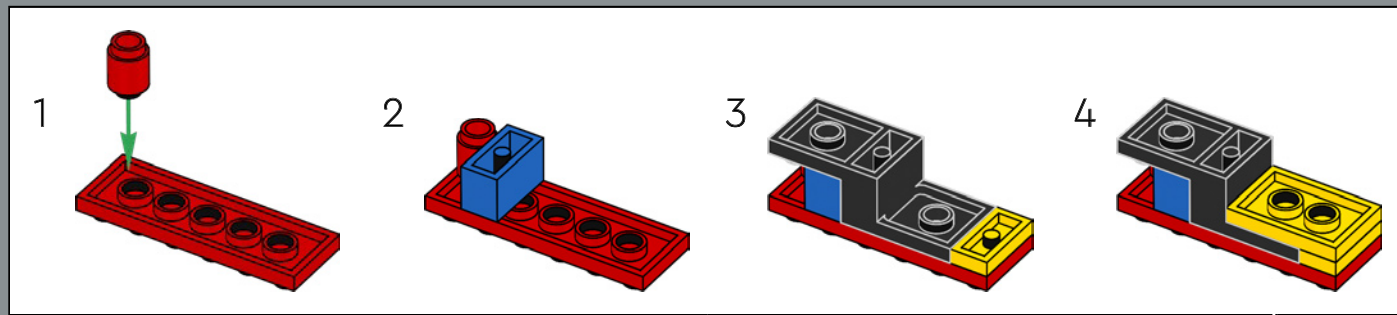

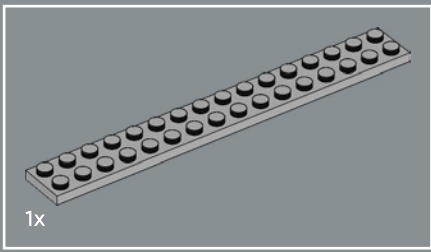

304

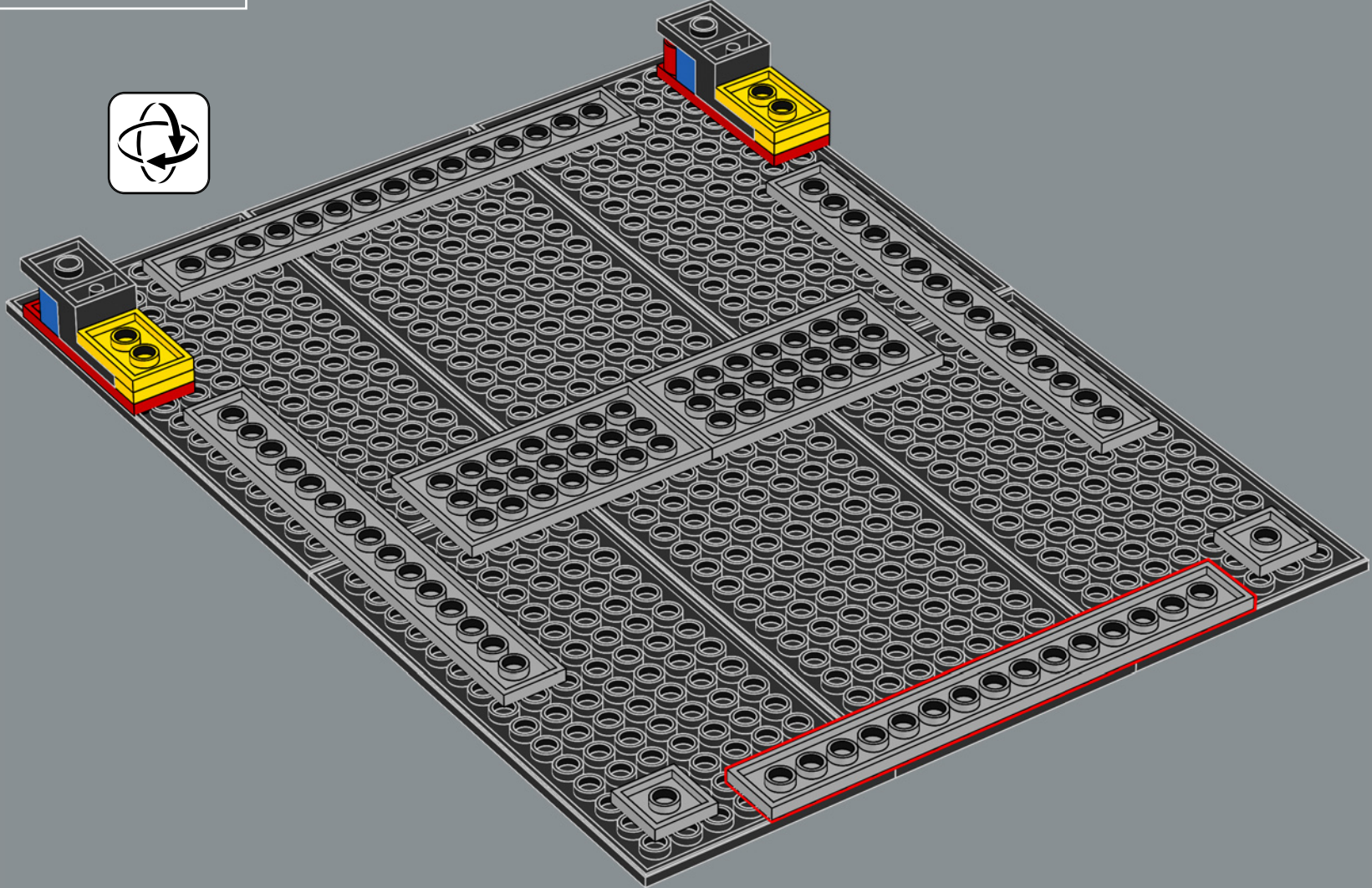

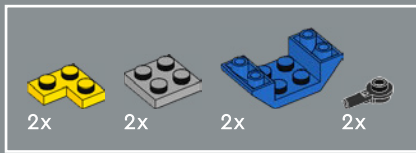

305

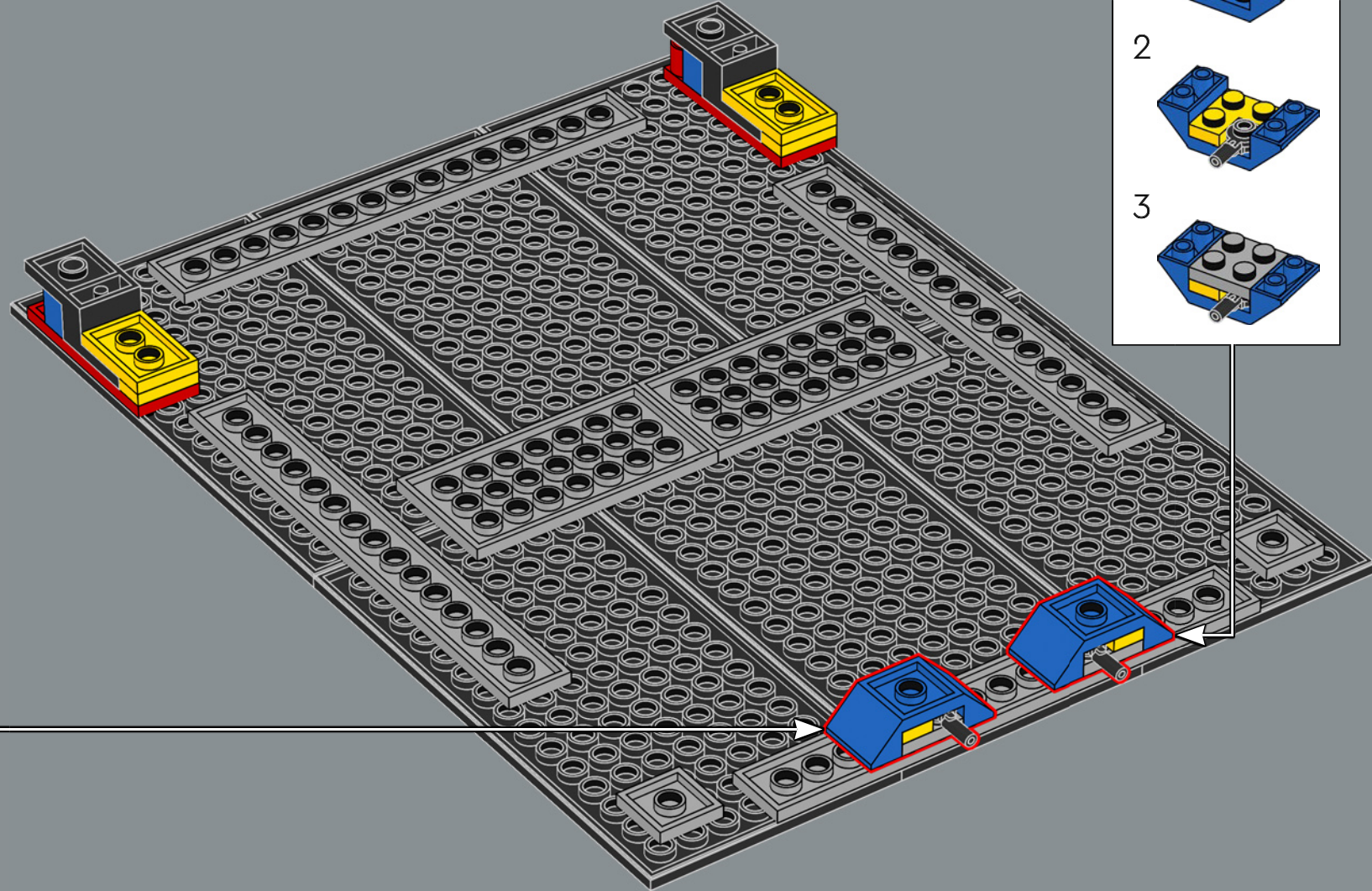
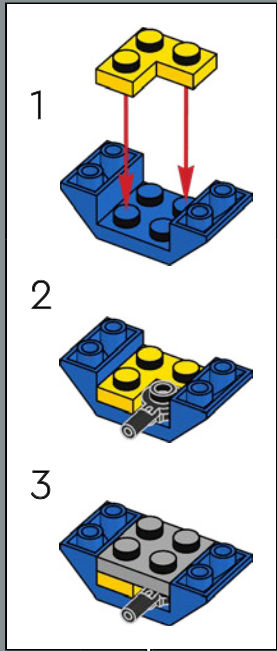
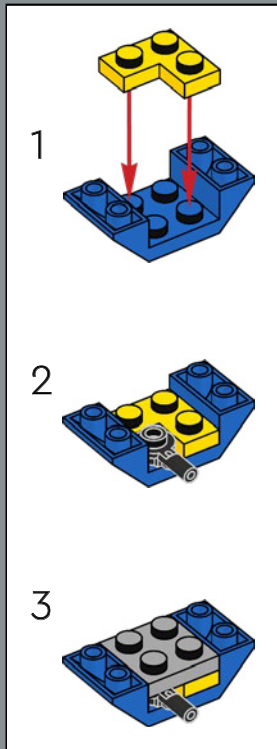

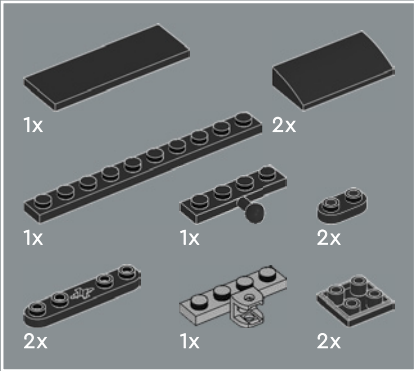
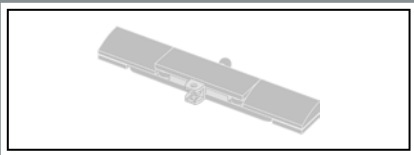

306

1

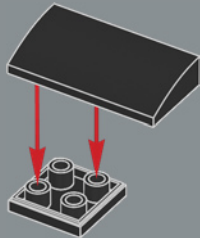

2

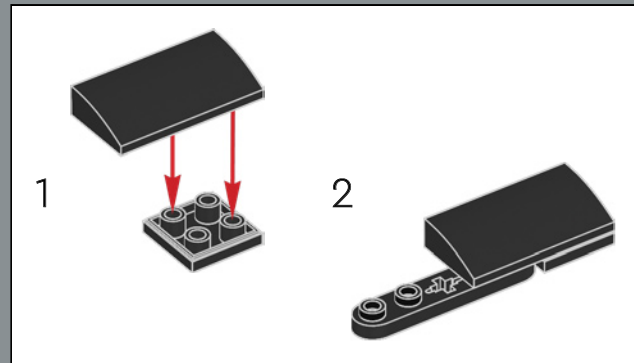
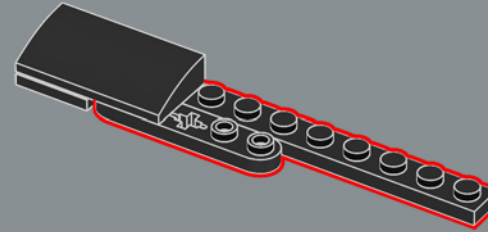

3

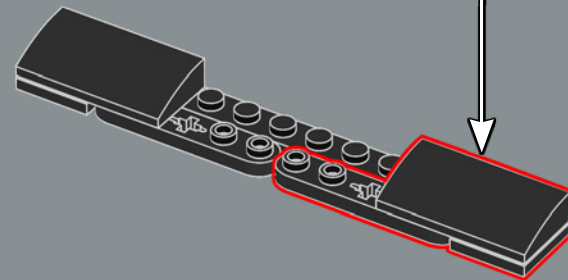

4

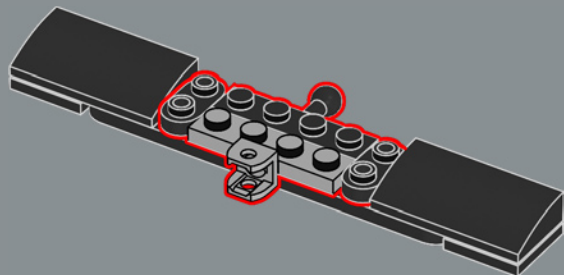

5

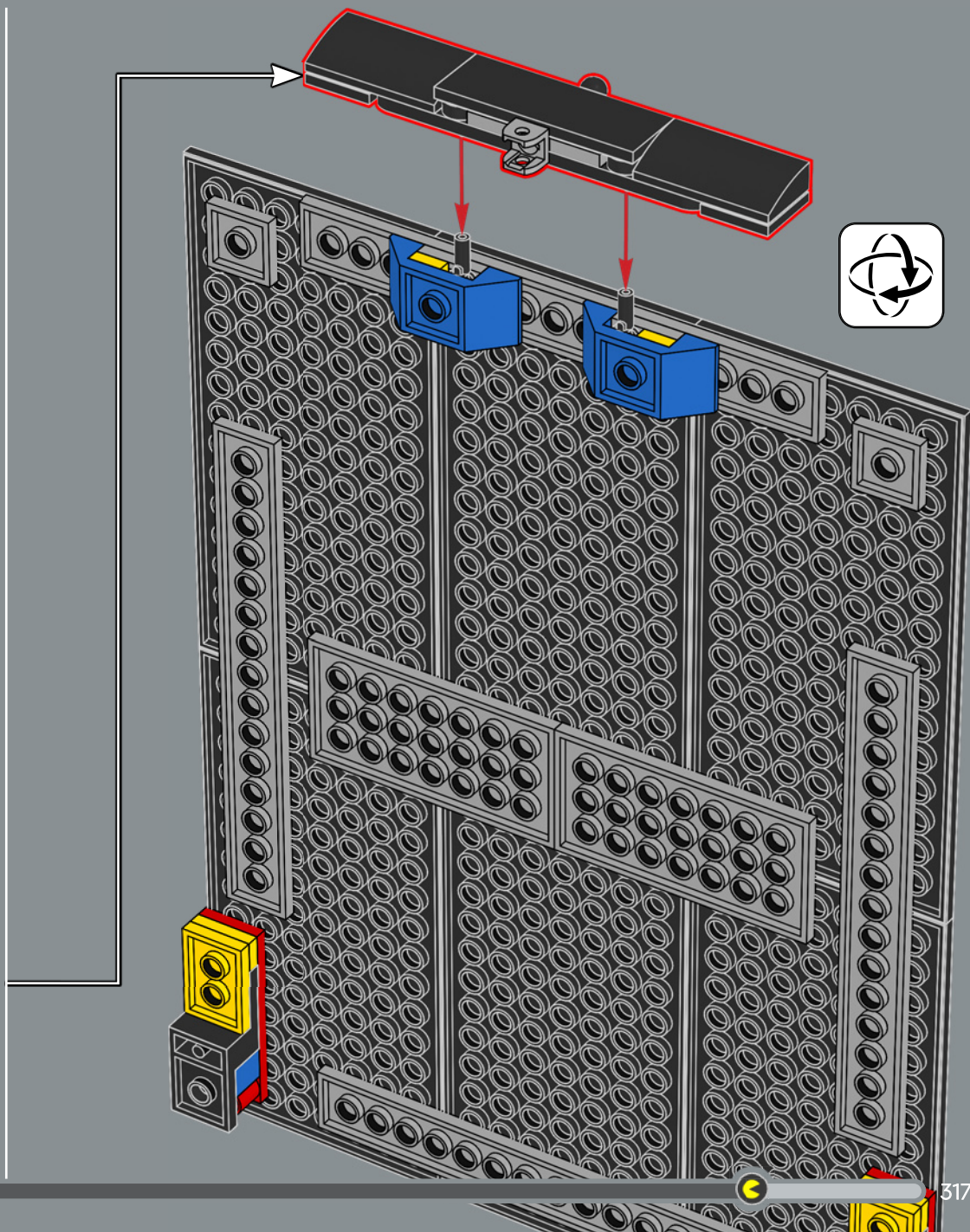
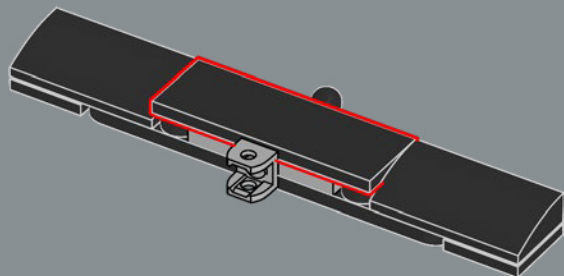

307

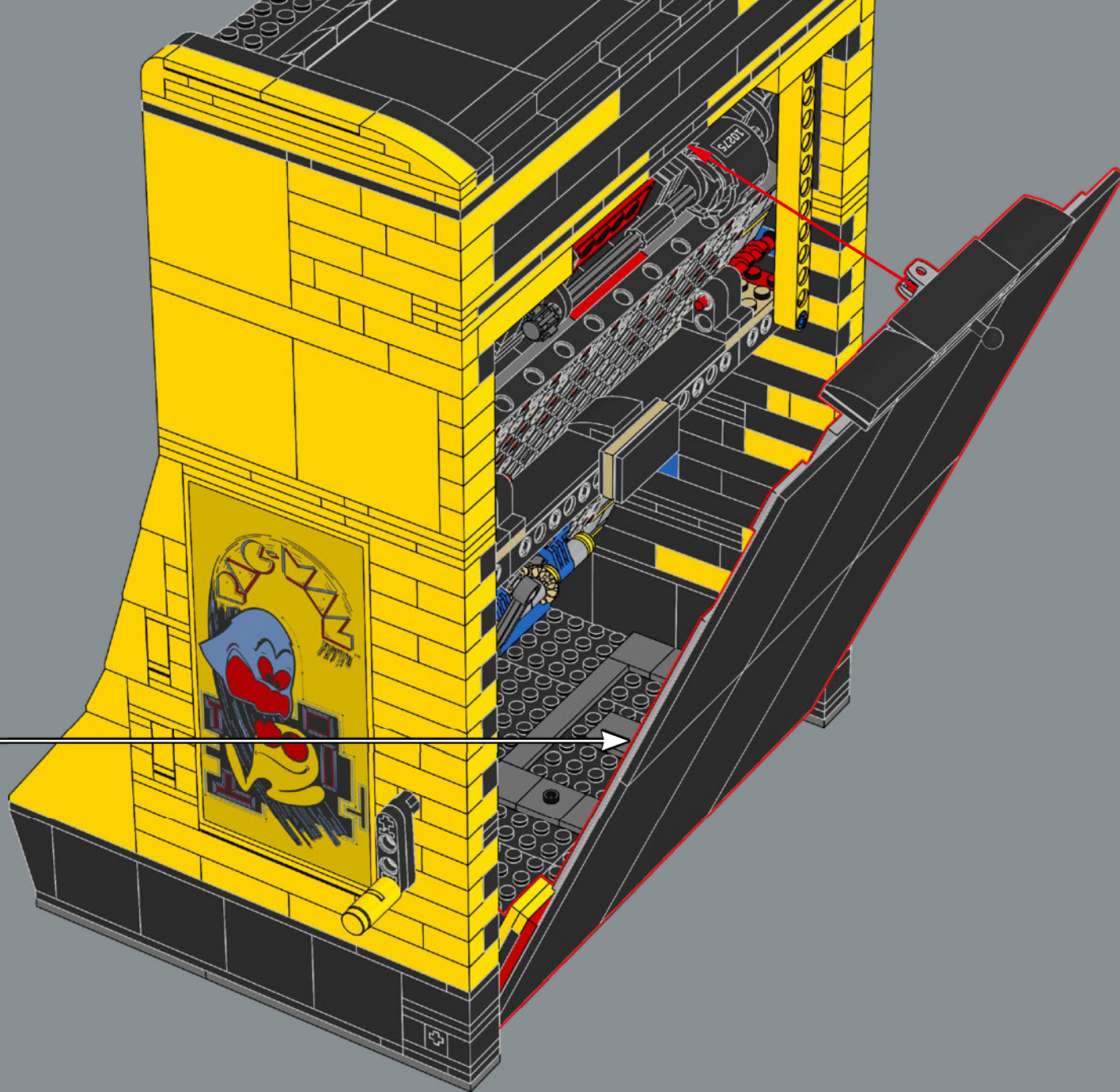

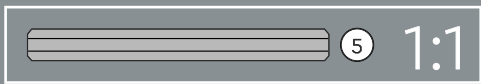
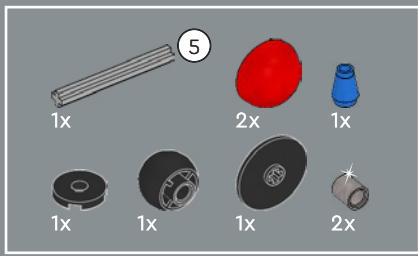

308

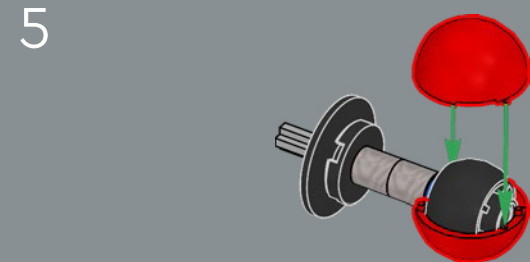
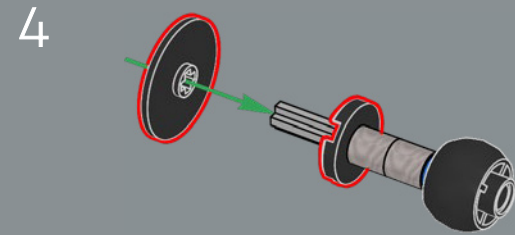
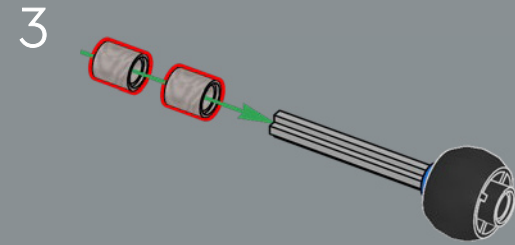
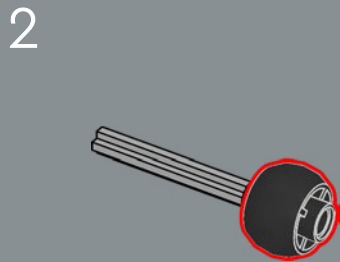
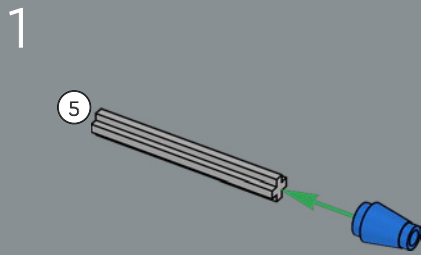

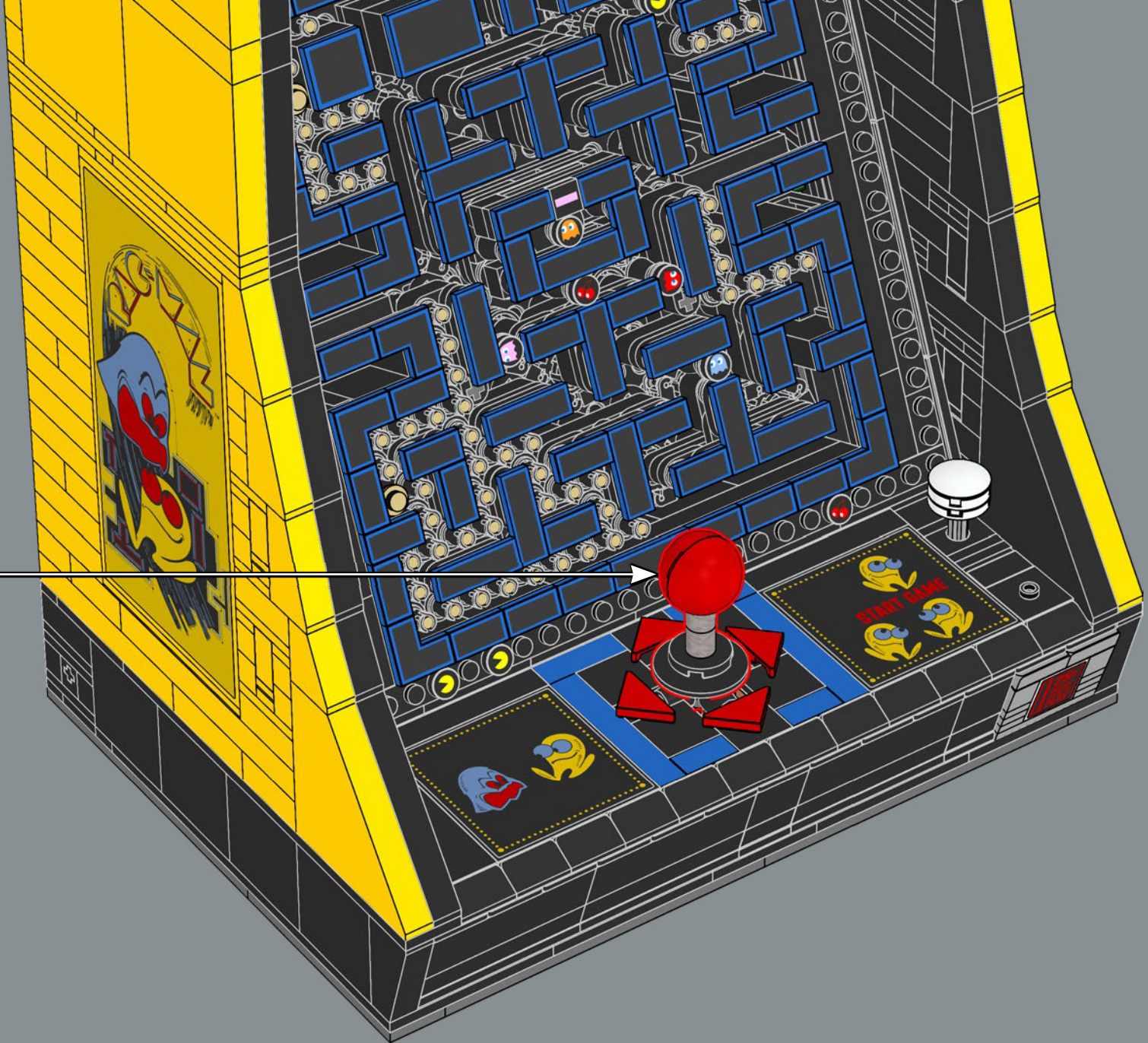



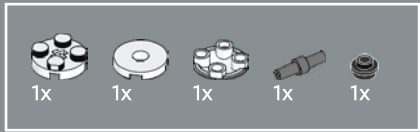

309

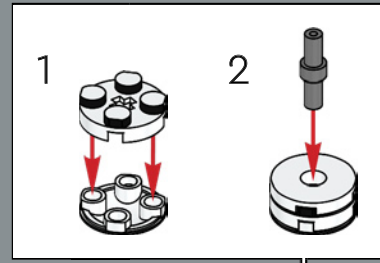
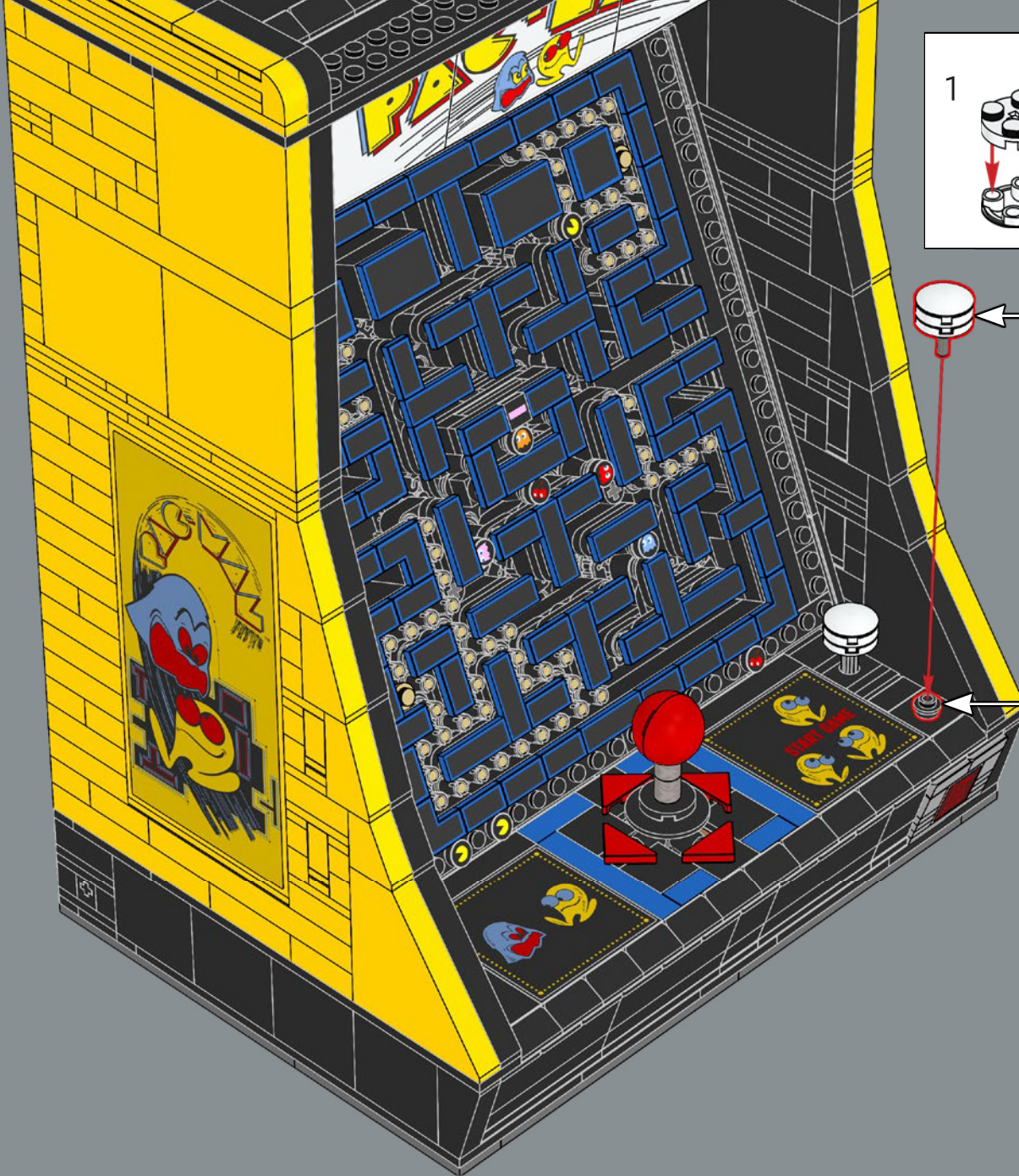



Mr. Iwatani is a big fan of pinball, and the graphic design for the original arcade version of PAC-MAN was inspired by game boards and slot machines.

M. Iwatani est un grand amateur de billard électrique, et la conception graphique de la version originale de PAC-MAN pour arcade s'est inspirée des plateaux de jeu et des machines à sous.

El Sr. Iwatani es un gran aficionado al *pinball*, y el diseño gráfico de la versión original de arcade de PAC-MAN se inspiró en los tableros de juego y las máquinas tragamonedas.

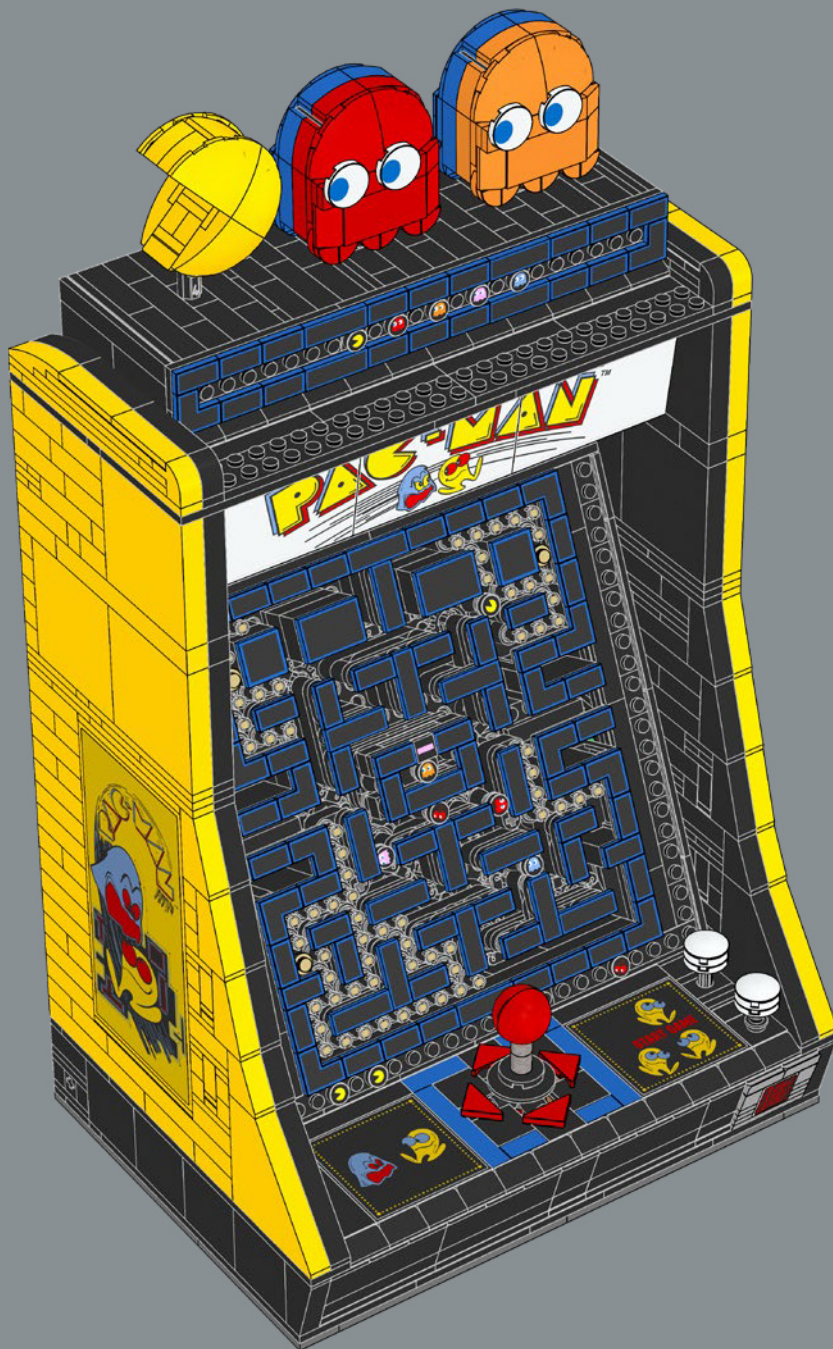

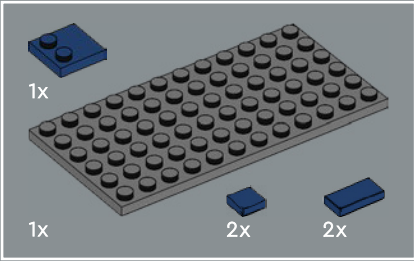
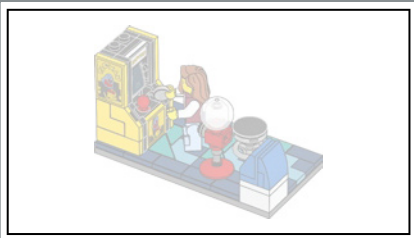

1

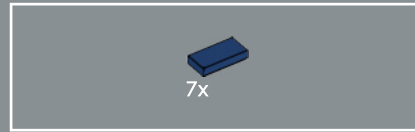
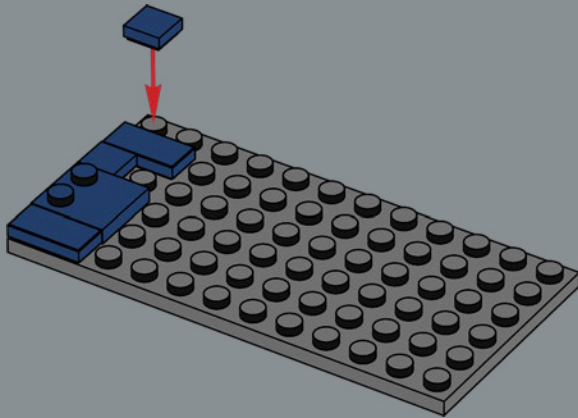

2

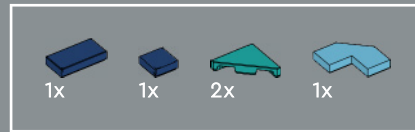
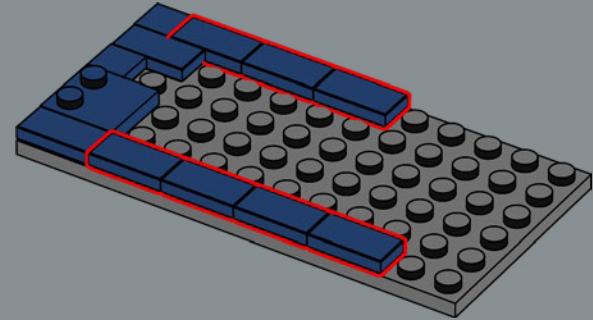

3

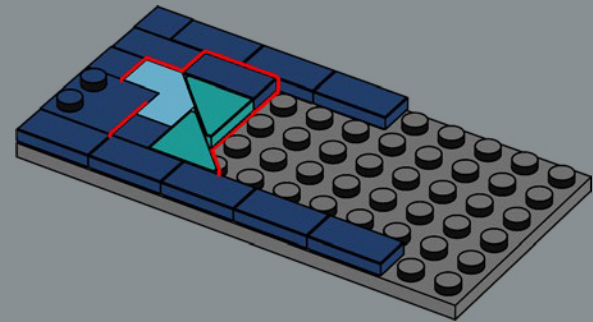



4

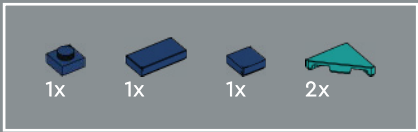
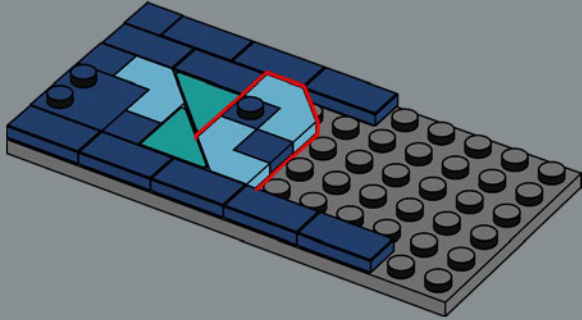

5

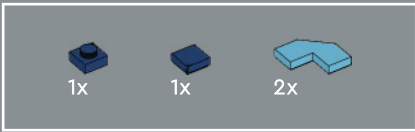
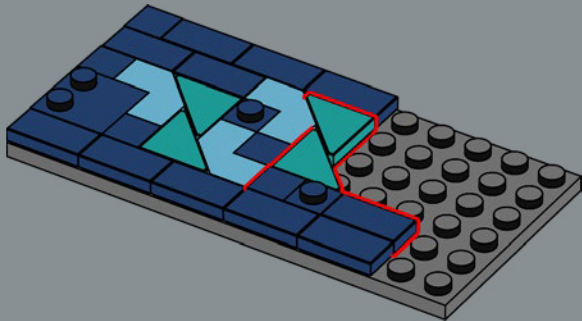

6

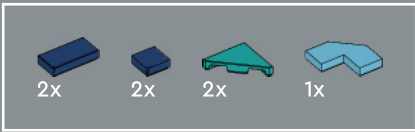
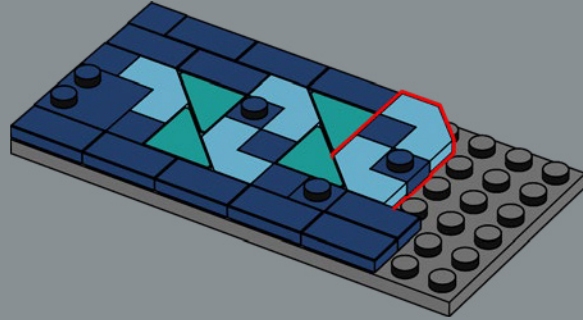

7

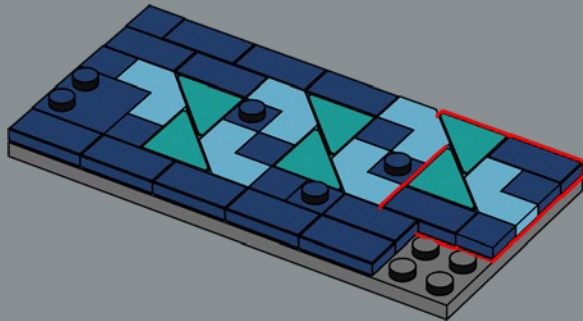

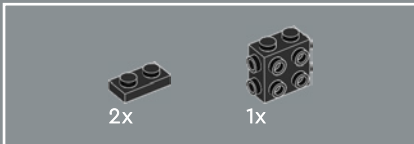
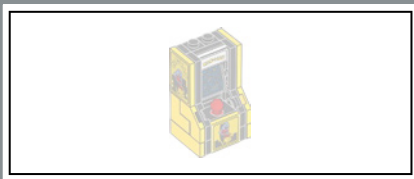

8

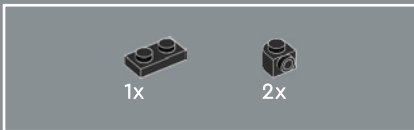
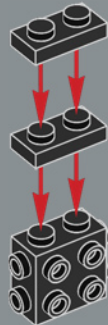

9

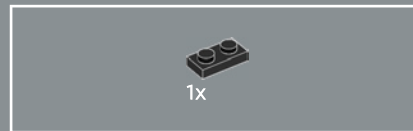
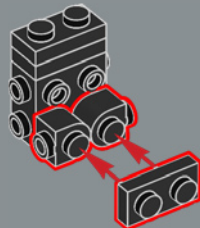

10

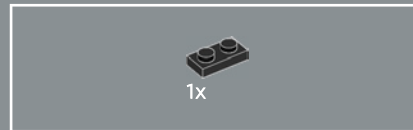
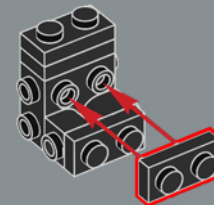

11

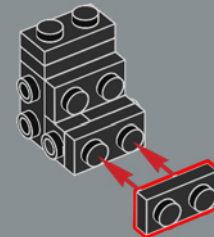

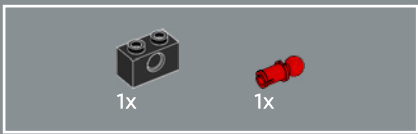

12

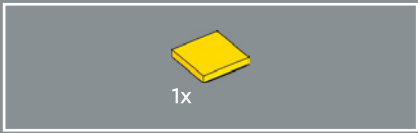
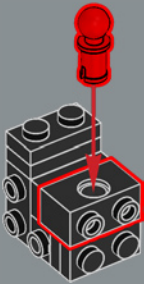

13

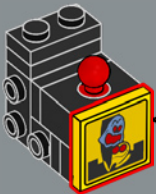
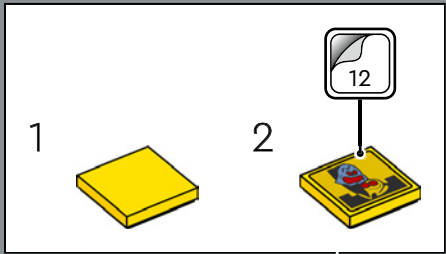

14

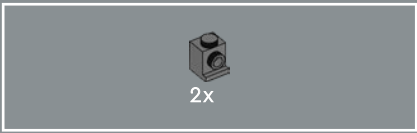
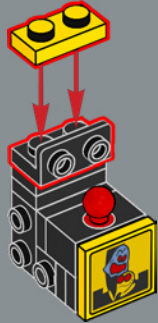

15

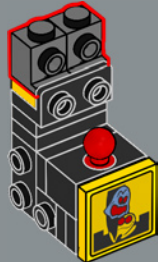



16

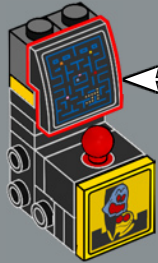
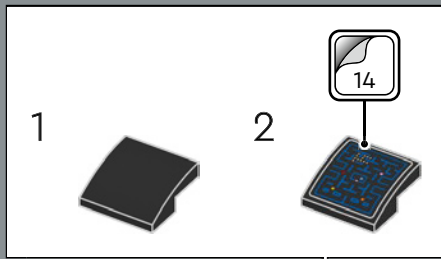

17

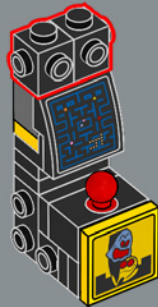

18

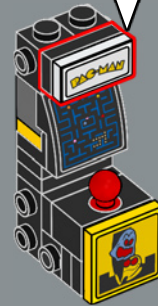
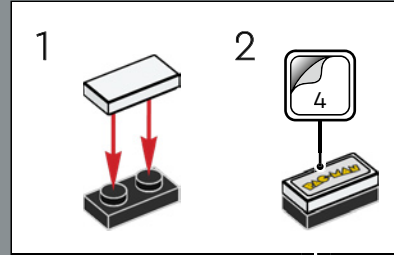

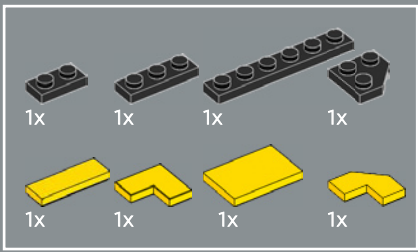

19

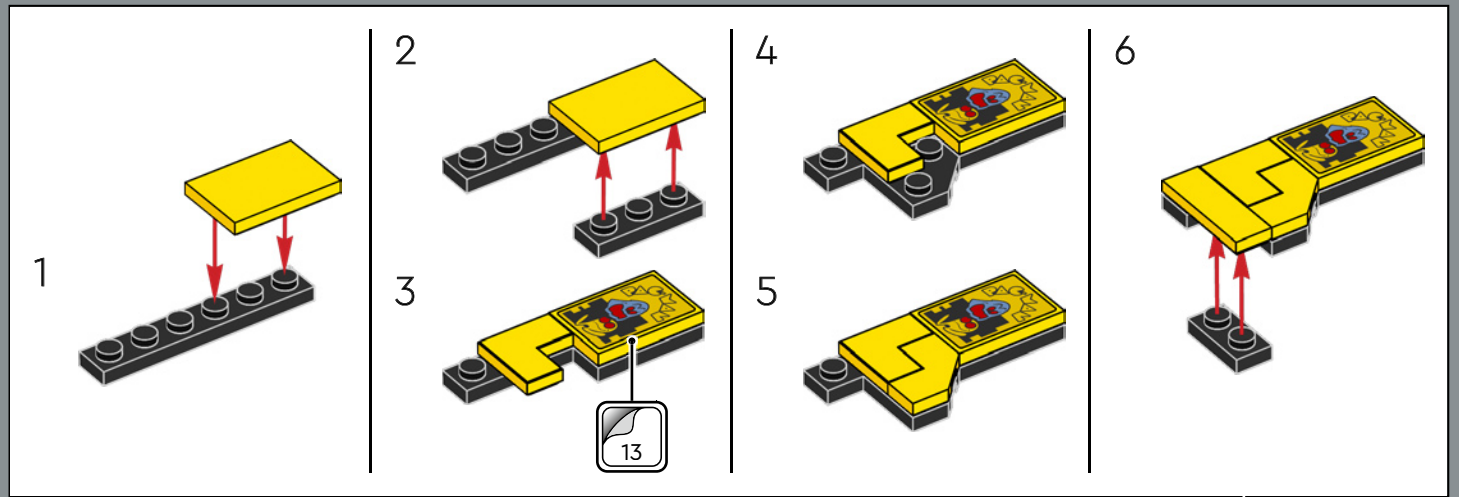



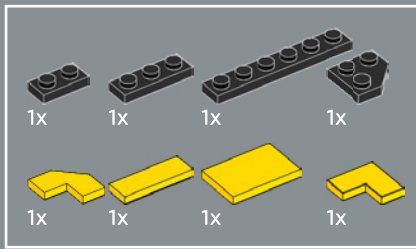

20

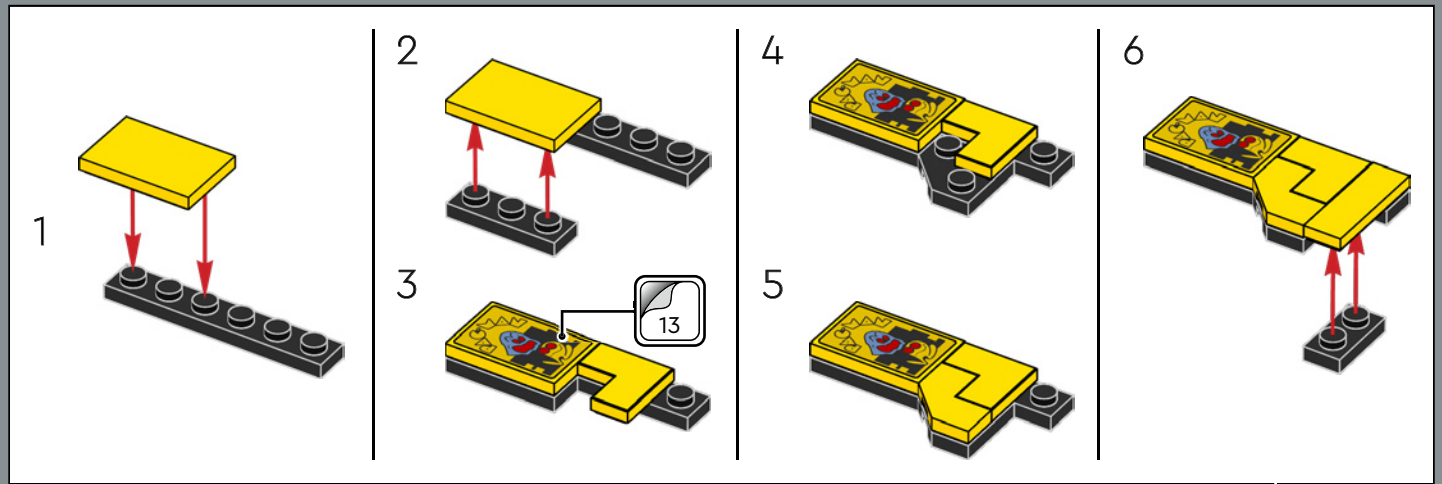

21

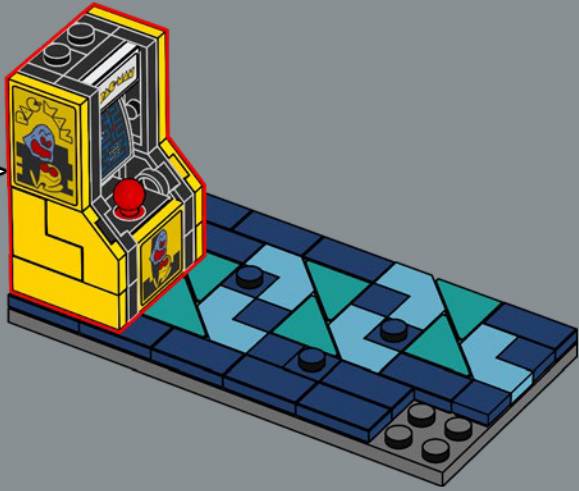

22

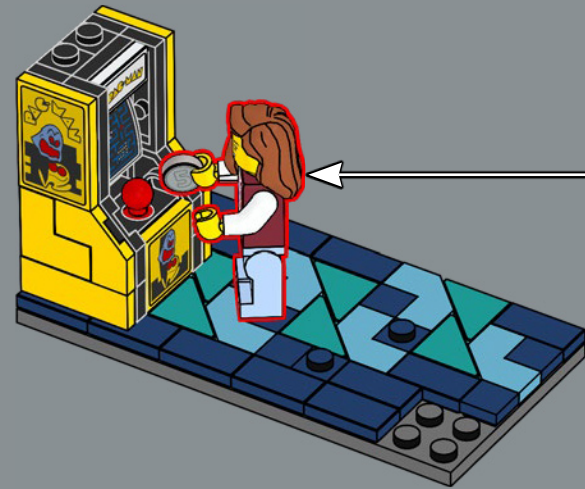
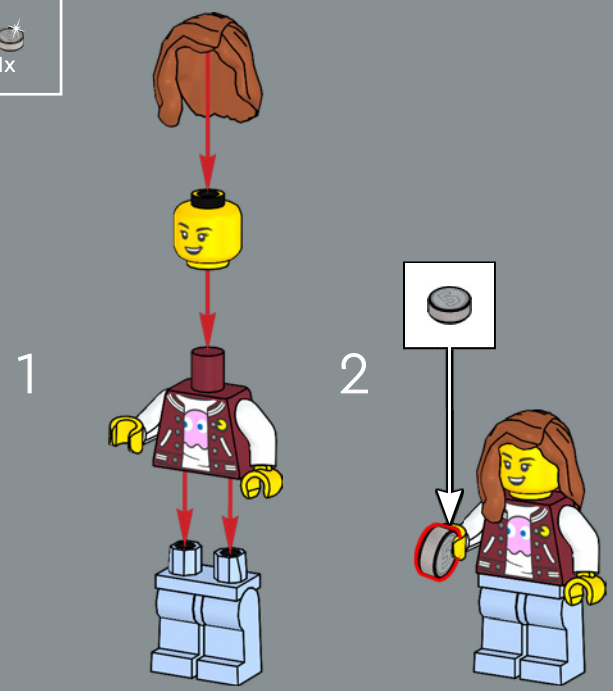

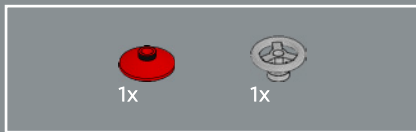

The vignette with the gamer minifigure and PAC-MAN console is a tribute to the classic arcade game halls.

La vignette avec la figurine de joueur et la console PAC-MAN rend hommage aux salles de jeux d'arcade classiques.

La viñeta con la minifigura del jugador y la consola de PAC-MAN es un homenaje a las clásicas salas de arcade.

23

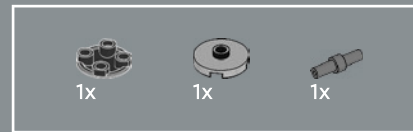

24

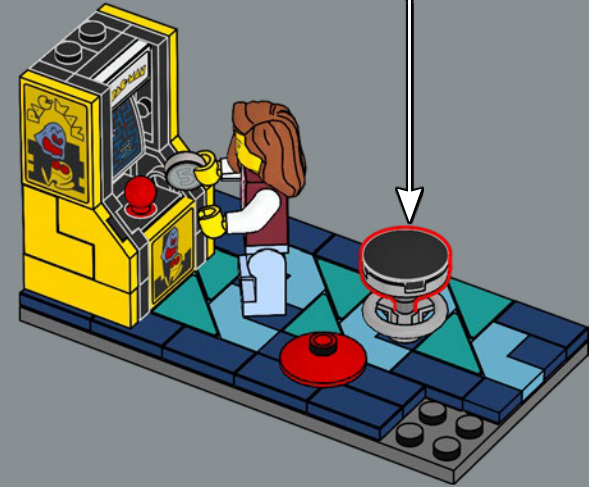
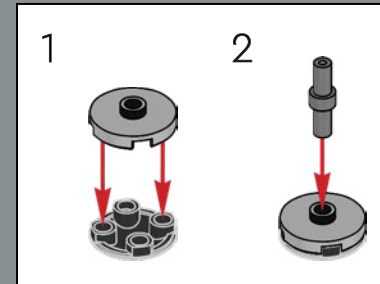



25

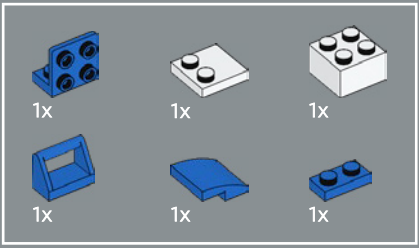
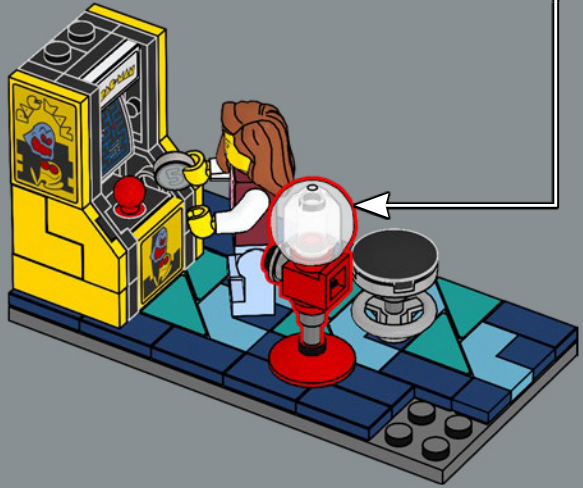
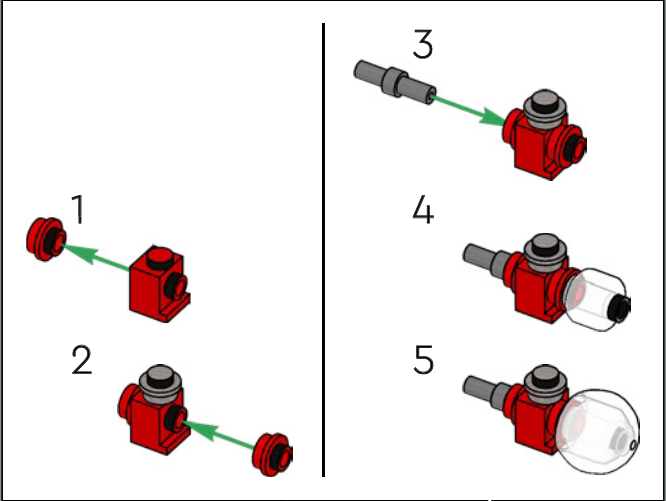

26

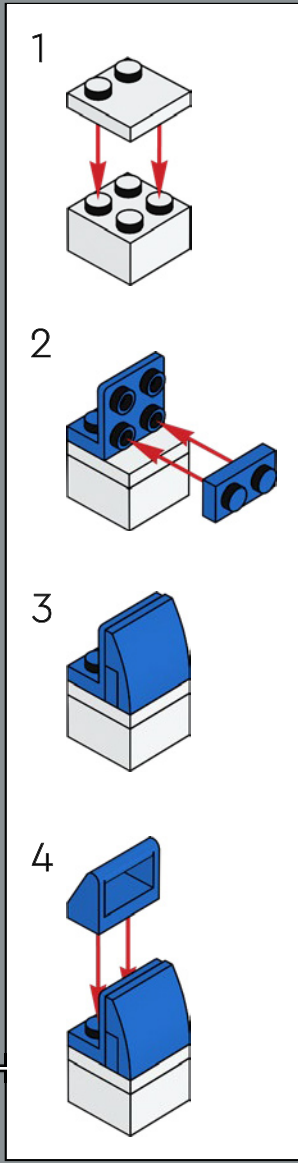
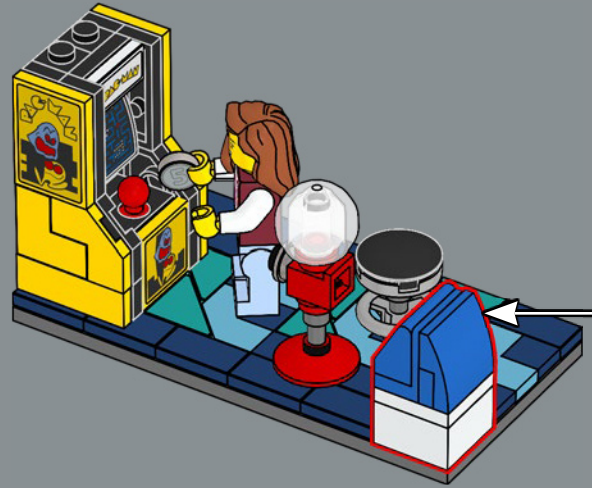

27

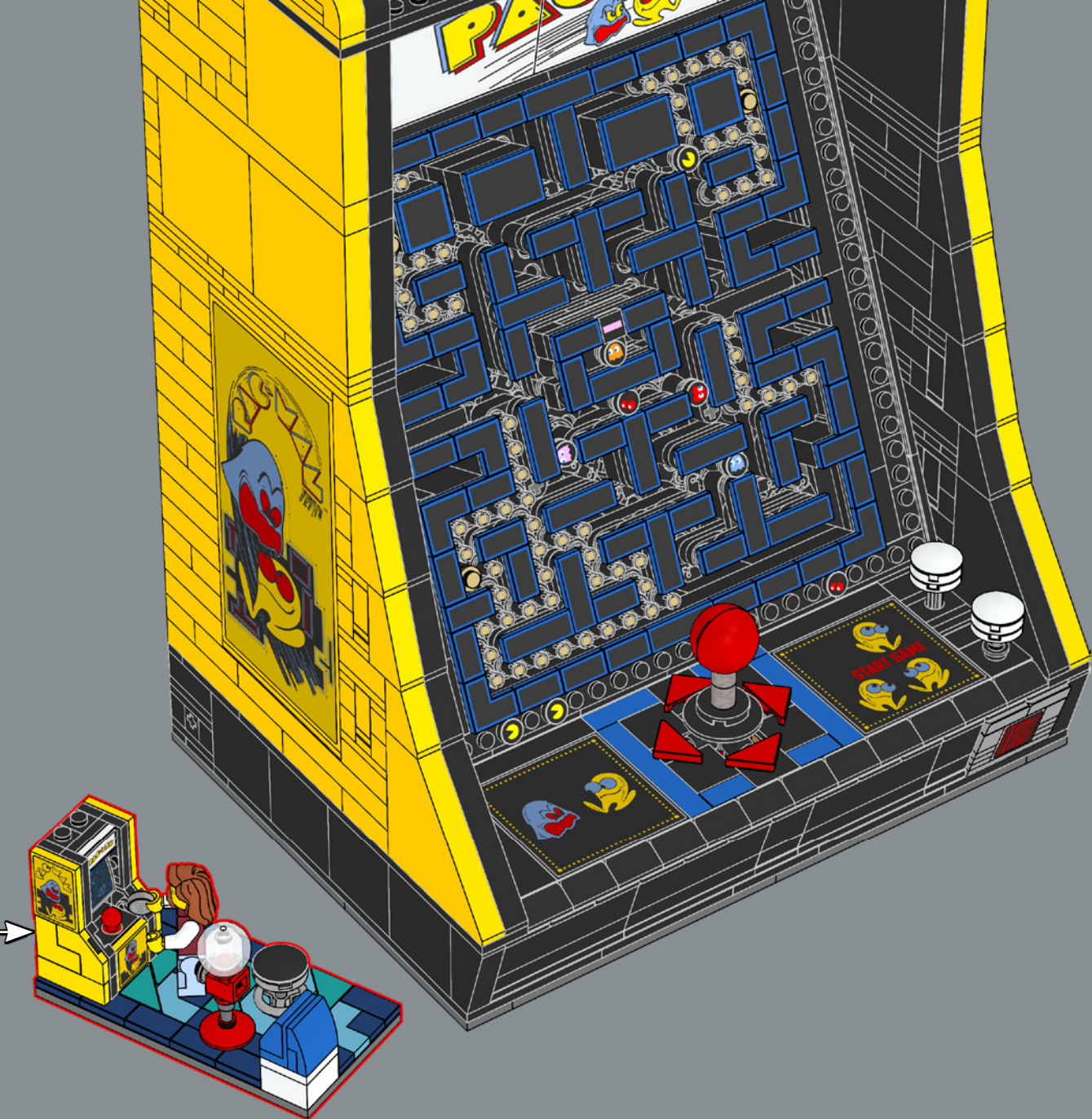

28

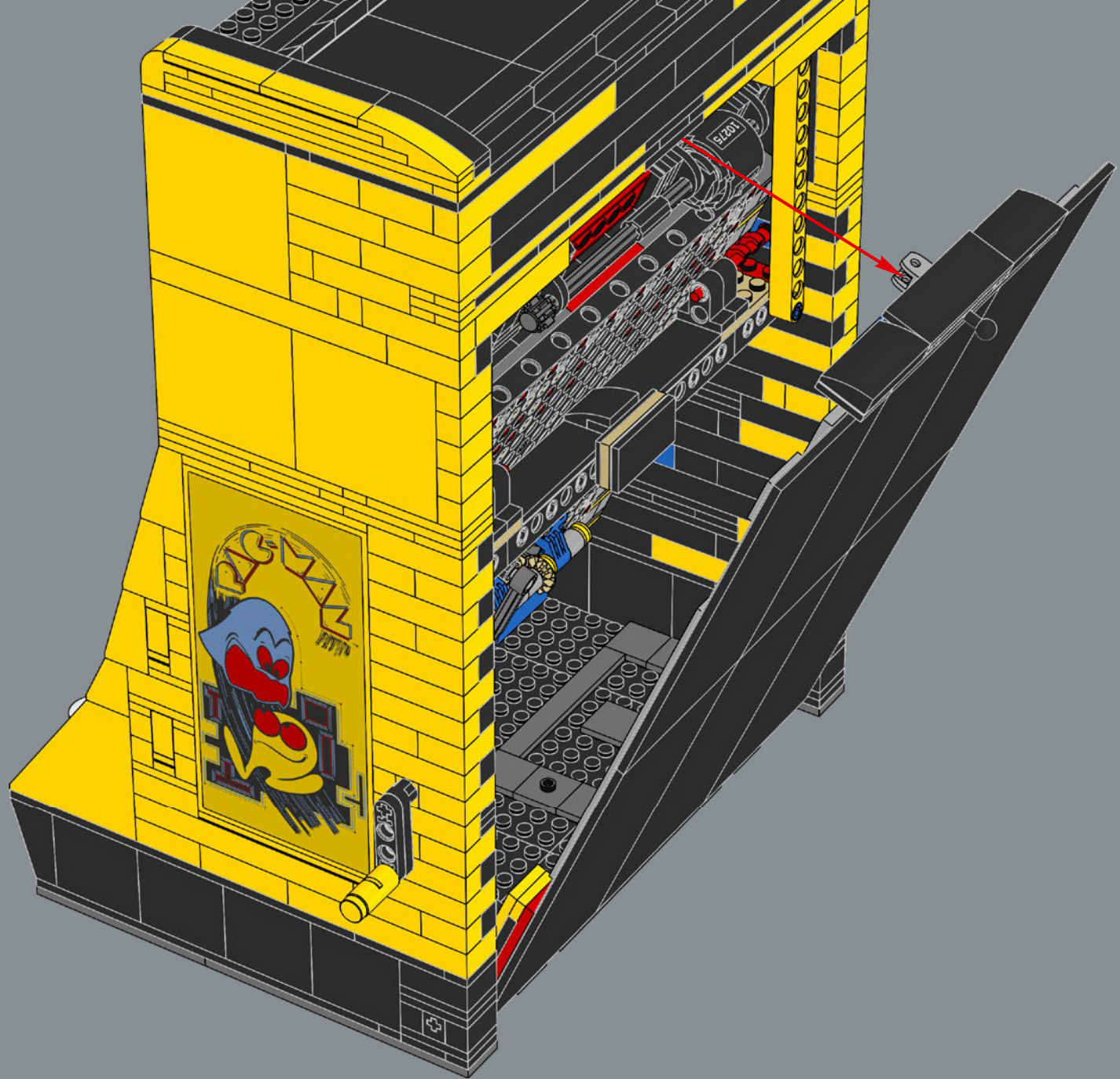

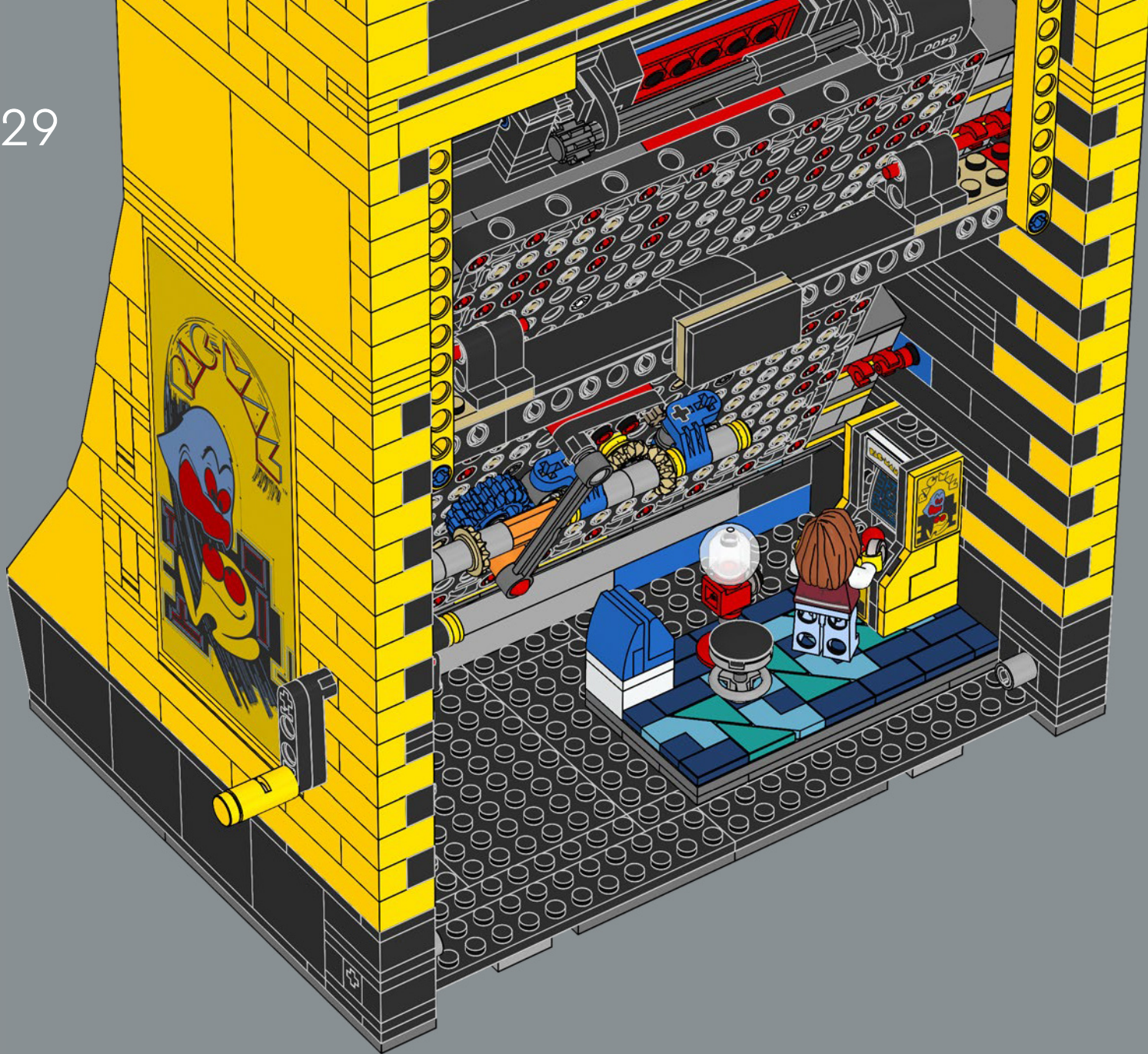

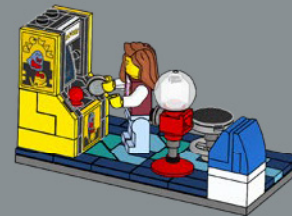
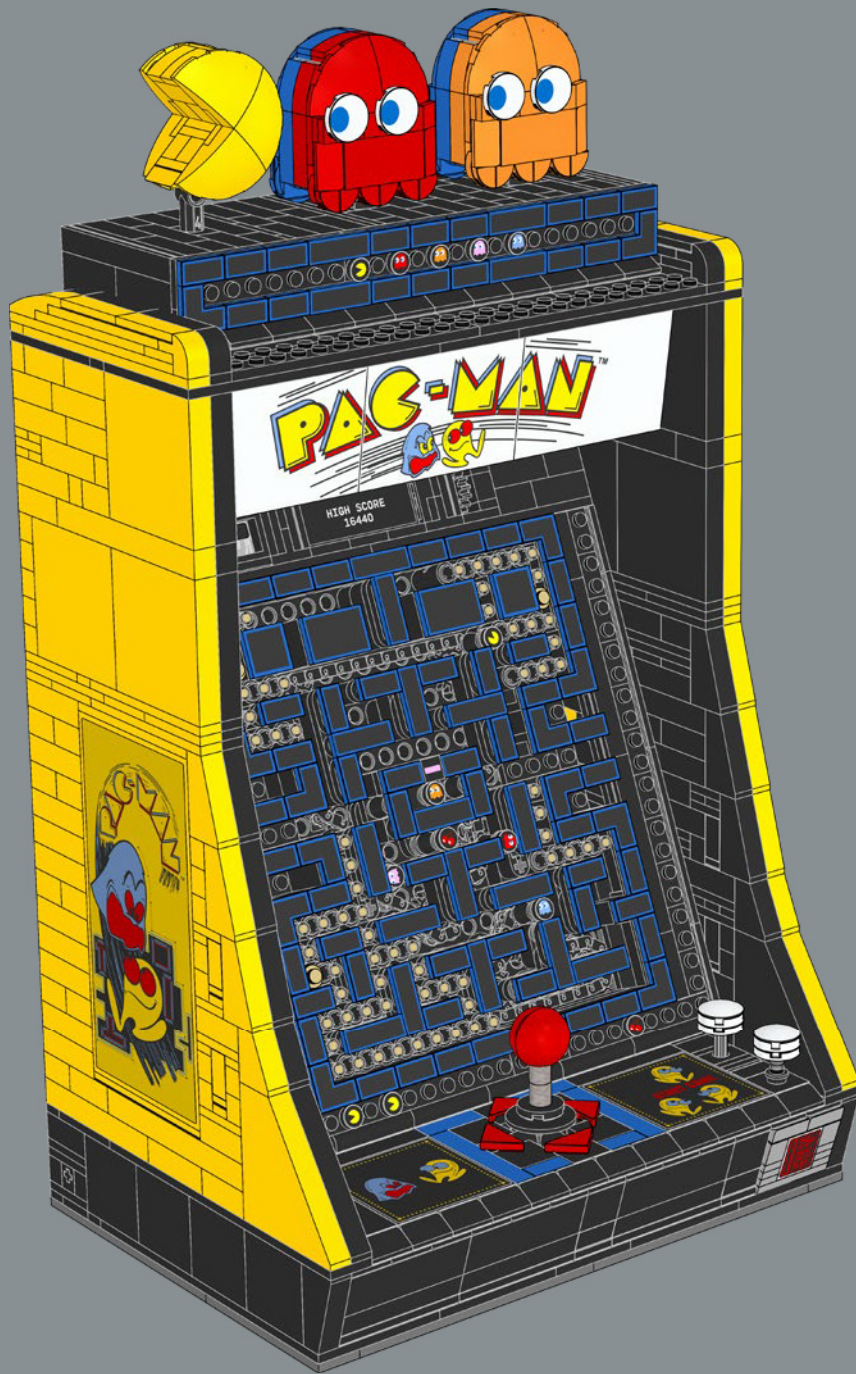





#### EN

##### Important information about batteries

Never use different types of batteries together, or a combination of old and new batteries. Always remove the batteries if the product is not to be used for a long time or if the batteries have run down. Never use damaged batteries. Only use alkaline type batteries. Insert the batteries so that the poles are correctly positioned. Never attempt to recharge non-rechargeable batteries. Never short-circuit the battery holder.

#### DE

##### Wichtige Informationen zu Batterien

Benutzen Sie niemals unterschiedliche Arten von Batterien oder alte und neue gleichzeitig. Nehmen Sie stets die Batterien heraus, wenn mit dem Modell längere Zeit nicht gespielt wird oder wenn die Batterien leer sind. Verwenden Sie niemals beschädigte Batterien. Verwenden Sie ausschließlich Alkali-Batterien. Achten Sie beim Einsetzen der Batterien auf die richtige Polung. Versuchen Sie unter keinen Umständen, „normale“ Batterien wieder aufzuladen. Schließen Sie das Batteriefach niemals kurz.

#### FR

##### Informations importantes concernant les piles

Ne jamais utiliser un mélange de différents types de piles, ou de piles neuves et de piles anciennes ou déjà utilisées. Toujours retirer les piles si le produit n'est pas utilisé durant une période prolongée ou si les piles sont vides. Ne jamais utiliser de piles endommagées. N'utiliser que des piles alcalines. En insérant les piles, respecter scrupuleusement le sens d'orientation des pôles (+/-). Ne jamais essayer de recharger des piles non rechargeables. Ne jamais court-circuiter le compartiment des piles.

#### IT

##### Importanti informazioni sulle batterie

Non usare mai contemporaneamente batterie di tipo diverso o batterie nuove e usate insieme. Rimuovere sempre le batterie qualora il prodotto non venga utilizzato per periodi prolungati, oppure se le batterie sono esauste. Non utilizzare mai batterie danneggiate. Utilizzare solo batterie di tipo alcalino. Inserire le batterie avendo cura che la loro polarità sia corretta. Non tentare mai di ricaricare batterie non ricaricabili. Non cortocircuitare mai il portabatterie.

#### NL

##### Belangrijke informatie over batterijen

Gebruik nooit verschillende soorten of een combinatie van oude en nieuwe batterijen tegelijkertijd. Verwijder de batterijen altijd als je het product lange tijd niet wilt gebruiken of als batterijen leeg zijn. Gebruik nooit beschadigde batterijen. Gebruik alleen alkalinebatterijen. Plaats de batterijen met de polen in de juiste richting. Probeer nooit niet-oplaadbare batterijen opnieuw op te laden. Laat de batterijhouder nooit kortsluiten.

#### ES

##### Información importante acerca de las pilas

No use pilas de diferentes tipos ni pilas nuevas y antiguas para alimentar el producto. Extraiga las pilas del producto si este va a permanecer sin uso durante un período prolongado de tiempo o aquellas se han agotado. No use pilas dañadas. Use solo pilas alcalinas. Inserte las pilas de modo que los polos queden situados en las posiciones correctas. No trate de cargar pilas no recargables. No cortocircuite el compartimento de las pilas.

#### DA

##### Vigtige oplysninger om batterier

Brug aldrig forskellige batterityper sammen eller en kombination af gamle og nye batterier. Fjern altid batterierne, hvis produktet ikke skal bruges i lang tid, eller hvis batterierne er flade. Brug aldrig beskadigede batterier. Brug kun alkaliske batterier. Sæt batterierne i, så polerne vender den rigtige vej. Forsøg aldrig at oplade ikke-genopladelige batterier. Kortslut aldrig batteriholderen.

#### IS

##### Mikilvægar upplýsingar um rafhlöður

Aldrei skal nota mismunandi gerðir rafhlaðna samtímis, né nýjar og eldri rafhlöður samtímis. Ef ekki á að nota tækið í lengri tíma eða ef rafhlöðurnar eru orðnar tómar skal fjarlægja rafhlöðurnar. Aldrei skal nota rafhlöður sem hafa skemmt. Eingöngu má nota alkaline-rafhlöður. Setja skal rafhlöðurnar í þannig að plús- og mínusskaut þeirra snúi rétt. Aldrei skal reyna að endurhlaða rafhlöður sem ekki eru endurhlaðanlegar. Aldrei ætti að valda skammhlaupi í rafhlöðuhólfinu.

#### FI

##### Tärkeää tietoa paristoista

Älä koskaan käytä erityyppisiä paristoja yhdessä. Älä myöskään käytä samassa laitteessa sekä vanhoja että uusia paristoja. Poista paristot tuotteesta aina, kun se on pitemmän aikaa käyttämättä, tai kun paristot ovat tyhjentyneet. Älä koskaan käytä viallisia paristoja. Käytä vain alkaliparistoja. Aseta paristot siten, että navat osoittavat oikeaan suuntaan. Älä koskaan aiheuta oikosulkuja pariston kosketintien välillä.

#### SV

##### Viktig information om batterier

Använd aldrig olika sorters batterier samtidigt, och inte heller en kombination av gamla och nya batterier. Ta alltid ur batterierna om produkten inte ska användas under en längre tid eller om batterierna är slut. Använd aldrig skadade batterier. Använd endast alkaliska batterier. Sätt i batterierna så att polerna hamnar i rätt läge. Försök aldrig ladda icke-laddningsbara batterier. Kortslut aldrig batteriutrymmets kontaktytor.

## NO

### Viktig informasjon om batterier

Bruk aldri ulike typer batterier sammen og heller aldri gamle og nye batterier sammen. Ta alltid ut batteriene hvis produktet ikke skal brukes på lang tid, eller hvis batteriene er brukt opp. Bruk aldri skadde batterier. Bruk bare alkaliske batterier. Sett inn batteriene med polene vendt riktig vei. Forsøk aldri å lade opp ikke-oppladbare batterier. Kortslett aldri batteriholderen.

## PT

### Informação importante sobre as pilhas

Nunca use diferentes tipos de pilhas em simultâneo, ou uma combinação de pilhas usadas e novas. Retire sempre as pilhas se o produto não for usado durante muito tempo ou se as pilhas já não tiverem carga. Nunca use pilhas danificadas. Use apenas pilhas alcalinas. Insira as pilhas de forma a que os polos fiquem corretamente posicionados. Nunca tente recarregar pilhas não recarregáveis. Nunca deixe o compartimento das pilhas entrar em curto-circuito.

## EL

### Σημαντικές πληροφορίες για τις μπαταρίες

Μην χρησιμοποιείτε ποτέ διαφορετικούς τύπους μπαταριών μαζί και μην συνδυάζετε παλιές και καινούργιες μπαταρίες. Αφαιρείτε πάντα τις μπαταρίες αν δεν σκοπεύετε να χρησιμοποιήσετε το προϊόν για αρκετό καιρό ή αν οι μπαταρίες έχουν αδειάσει. Ποτέ μην χρησιμοποιείτε μπαταρίες που έχουν φθορές. Χρησιμοποιείτε μόνο αλκαλικές μπαταρίες. Τοποθετήστε τις μπαταρίες με τους πόλους στη σωστή θέση. Μην επιχειρήσετε ποτέ να επαναφορτίσετε μη επαναφορτιζόμενες μπαταρίες. Ποτέ μην βραχυκυκλώνετε τη θήκη των μπαταριών.

## JA

### 電池取扱いに関する重要事項

異なるタイプの電池や古い電池を混ぜて使用しないでください。商品を長時間使用しないときや電池が切れたときは、電池を必ず取り外してください。不具合のある電池は絶対に使用しないでください。アルカリタイプの電池のみを使用してください。電極を確認して電池を正しい向きに入れてください。充電式ではない電池は絶対に充電しないでください。電池ホルダをショートさせないでください。

## ZH

### 電池使用注意事項

请勿同时使用不同类型的电池，或把新旧程度不同的电池混合使用。如果产品将有很长时间不会使用，或者电池已经没电，请注意取出电池。切勿使用已破损的电池。仅可使用碱性电池。装入电池时请注意正负极。请勿尝试给非充电电池充电。切勿对电池仓进行短路连接。

## KO

### 배터리 사용 시 주의사항

다른 종류의 배터리를 함께 사용하거나, 새 전지와 오래된 전지를 혼용하지 마세요. 배터리가 방전되었거나 장기간 제품을 작동하지 않을 때에는 반드시 배터리를 분리하세요. 파손된 배터리는 사용하지 마세요. 알칼라인 타입의 배터리만을 사용하세요. 양극과 음극의 위치를 잘 맞춰서 넣으세요. 일반 배터리는 충전해서 사용할 수 없습니다. 배터리 홀더의 접촉부에 배터리를 정확히 끼워서 사용하세요.

## RU

### Необходимая информация об элементах питания

Ни в коем случае не используйте одновременно элементы питания различных типов, а также элементы питания с разным сроком годности. В обязательном порядке вынимайте элементы питания из терминалов в случае, если вы не пользуетесь прибором в течение долгого времени, либо в случае, если в элементах питания закончился заряд. Ни в коем случае не используйте поврежденные элементы питания. Используйте только элементы питания щелочного типа. Установите элементы питания, соблюдая указанную полярность. Ни в коем случае не пытайтесь подзарядить перезаряжаемые элементы питания. Ни в коем случае не пытайтесь замкнуть полюса в устройстве для элементов питания.

## PL

### Ważne informacje dotyczące baterii

Nigdy nie należy stosować razem różnych rodzajów baterii ani stosować równocześnie starych i nowych baterii. Jeżeli produkt nie jest używany przez dłuższy czas lub jeżeli baterie się wyczerpały, należy wyjąć baterie. Nigdy nie należy stosować uszkodzonych baterii. Należy używać wyłącznie baterii alkalicznych. Przy wkładaniu baterii należy zwrócić uwagę na właściwe położenie biegunów. Nigdy nie należy próbować ładowania baterii jednorazowych. Nigdy nie należy doprowadzać do zwarcia w gnieździe baterii.

## CZ

### Důležitá informace o bateriích

Nikdy nepoužívejte najednou různé typy baterií nebo kombinaci starých a nových baterií. Nebude-li se výrobek delší dobu používat nebo jsou-li baterie vybité, vždy je vyjměte z výrobku. Nikdy nepoužívejte poškozené baterie. Používejte pouze alkalické baterie. Baterie instalujte se správnou orientací pólů. Nikdy se nesnažte nabíjet baterie, které nejsou nabíjecí. Nikdy nezkratujte kontakty v prostoru pro baterie.

## SK

### Dôležitá informácia o batériách

Nikdy nepoužívajte naraz odlišné typy batérií ani nekombinujte staré batérie s novými. Batérie vždy vyberte, ak sa výrobok nebude dlhšie používať, alebo ak sa batérie vybili. Nikdy nepoužívajte poškodené batérie. Používajte iba alkalické batérie. Batérie vkladajte so správnou orientáciou pólou. Nikdy sa nesnažte nabíjať batérie, ktoré nie sú nabíjateľné. Nikdy neskratujte kontakty v priestore pre batérie.

## HU

### Fontos tudnivalók az elemekről

Soha ne használjon különböző típusú elemeket, illetve ne használjon vegyesen új és használt elemeket. Mindig távolítsa el az elemeket, ha a készüléket előre láthatóan hosszabb ideig nem fogják használni, vagy ha az elemek lemerültek. Soha ne használjon megrongálódott elemeket. Csak alkáli elemeket használjon! Az elemeket helyesen helyezze be, a polaritásuknak megfelelően. Soha ne próbálja meg feltölteni a nem tölthető elemeket. Soha ne hozzon létre rövidzárlatot az elemtartó kivezetésén.

## UA

### Необхідна інформація про батарейки

Ніколи не використовуйте одночасно батарейки різних типів або батарейки з різним терміном придатності. Обов'язково вилучайте батарейки з приладу, якщо довго не користуєтесь ним, або якщо в батарейках уже скінчився заряд. Ніколи не використовуйте пошкоджені батарейки. Використовуйте лише лужні батарейки. Вставляйте батарейки, враховуючи задану полярність. У будь-якому випадку не намагайтеся підзарядити батарейки, що не підлягають підзарядці. У будь-якому випадку не намагайтеся зробити коротке замикання в приладі для батарей.

## HR

### Važne obavijesti o bateriji

Nikada nemoj koristiti različite vrste baterija zajedno, isto tako ni kombinaciju starih i novih baterija. Uvijek izvadite baterije ako dugo nećeš koristiti proizvod ili ako su one potrošene. Nikada nemoj koristiti oštećene baterije. Upotrebjavajte samo alkalne baterije. Umetni baterije pazeći da dobro okreneš polove. Nikada ne pokušavaj puniti baterije koje nisu predviđene za punjenje. Nikada ne izazivaj kratki spoj u držaču baterija.

## SR

### Важне информације о батеријама

Никада не користите различите типове батерија заједно нити комбинацију старих и нових батерија. Увек извадите батерије уколико производ нећете дуже време користити или уколико су батерије празне. Никада не користите оштећене батерије. Користите само алкалне батерије. Ставите батерије тако да су полови правилно позиционирани. Никада не покушавајте да пуните батерије које не могу да се пуне. Никада не изазивајте кратак спој у кућишту за батерије.

## МК

### Важни информации за батериите

Никогаш не користете различити типови батерији заједно или комбинација од стари и нови батерији. Секогаш отстранувајте ги батериите доколку не го користите производот подолго време или доколку се потрошиле. Никогаш не користете оштетени батерији. Користете само алкални батерији. Вметнете ги батериите така што точно ќе ги наместите половите. Никогаш не обидувајте се да ги полните батериите за еднократна употреба. Никогаш не предизвикувајте краток спој на држачот за батерији.

## SL

### Pomembne informacije o baterijah

Nikoli ne uporabljajte skupaj različnih baterij ali kombinacije starih in novih baterij. Vedno odstranite baterije, če izdelka dlje časa ne boste uporabljali ali če so iztrošene. Nikoli ne uporabljajte poškodovanih baterij. Uporabljajte le alkalne baterije. Baterije vstavite tako, da so njihovi polji pravilno obrnjeni. Nikoli ne poskušajte polniti baterij, ki niso akumulatorske. Pazite, da ležišč za baterije ne boste spravili v kratek stik.

## RO

### Informații importante despre baterii

Nu folosiți niciodată împreună tipuri diferite de baterii, sau o combinație de baterii vechi și noi. Îndepărtați întotdeauna bateriile dacă produsul nu este folosit timp îndelungat sau dacă bateriile s-au epuizat. Nu folosiți niciodată baterii deteriorate. Utilizați numai baterii de tip alcalin. Introduceți bateriile astfel ca polii să fie poziționați corect. Nu încercați niciodată să reîncărcați baterii nereîncărcabile.

Nu scurtcircuitați niciodată suportul bateriei.

## BG

### Важна информација за батериите

Никога не използвайте едновременно различни типове батерији или комбинация от стари и нови батерији. Винаги изваждайте батериите, ако изделите няма да се използва продължително време или ако батериите са се изтозили. Никога не използвайте повредени батерији. Използвайте само алкални батерији. Поставете батериите така, че полюсите да са разположени правилно. Никога не опитвайте да зареждате батерији, които не са акумулаторни. Никога не свързвайте на късо контактите на отделението за батериите.

## LV

### Svarīga informācija par baterijām

Nekad vienlaikus nelietojiet dažādu tipu, kā arī vecas un jaunas baterijas. Vienmēr izņemiet baterijas, ja tās ir izlādējušās vai ja produkts ilgāku laiku netiek lietots. Nekad nelietojiet bojātas baterijas. Izmantojiet tikai sārma tipa baterijas. Ievietojiet baterijas, ievērojiet pareizu polaritāti. Nekad nemēģiniet uzlādēt baterijas, kas nav uzlādējamās. Nepieļaujiet issavienojumu bateriju nodalījumā.

## ET

### Oluline teave patareide kohta

Ära kunagi kasuta koos erinevat tüüpi patareisid, samuti vanu ja uusi patareisid. Kui märguasja ei kasutata pika aja jooksul, võta patarei sellest välja. Ära kunagi kasuta kahjustatud patareisid. Kasuta ainult leelispatareisid. Pane patareid märguasja sisse nii, et pluss- ja miinusklemmi asend oleks õige. Ära kunagi proovi akulaadijaga laadida tavalisi patareisid. Patareipesa klemmide vahel ei tohi tekkida lühis.

## LT

### Svarbi informacija apie elementus

Vienu metu nenaudokite skirtingų elementų, taip pat su naujais elementais nenaudokite senų. Jei nenaudosite gaminio ilgesnį laiką arba jei elementai išseko, visuomet išimkite juos iš gaminio. Niekada nenaudokite pažeistų elementų. Naudokite tik šarminius elementus. Elementus dėkite atsižvelgdami į jų poliškumą. Niekada nebandykite įkrauti vienkartinį elementų. Saugokitės, kad elementų įdėkle nesukeltumėte trumpojo jungimo.

## TR

### Piller hakkında önemli bilgiler

Hiçbir zaman farklı tipte pilleri ya da eski pillerle yeni pilleri bir arada kullanmayın. Ürün uzun süre kullanılmayacaksa ya da piller bitmişse, pilleri ürünün içinden çıkarın. Hiçbir zaman zedelenmiş piller kullanmayın. Sadece alkalın piller kullanın. Pilleri kutupları doğru konumda olacak şekilde yerleştirin. Hiçbir zaman, sarj edilebilir olmayan pilleri sarj etmeye çalışmayın. Hiçbir zaman pil kutusuna kısa devre yaptırmayın.

## AR

### معلومات مهمة عن البطاريات

يحظر استخدام أنواع مختلفة من البطاريات معا أو مزيج من البطاريات القديمة و الجديدة. احرص دائما على نزع البطاريات في حال عدم استخدام المنتج لفترة طويلة أو إذا نفذت طاقة البطاريات. تجنب استخدام البطاريات التالفة. لا تستخدم إلا البطاريات القلوية فقط. قم بتكيب البطاريات بحيث تكون الأقطاب في موضعها الصحيح. يحظر إعادة شحن البطاريات غير القابلة لإعادة الشحن. تجنب إحداث دائرة قصر في حامل البطارية.

## ID

### Informasi penting tentang baterai

Jangan gunakan baterai yang jenisnya berlainan, atau mencampur baterai lama dan baterai baru. Lepas baterai jika produk tidak akan digunakan untuk waktu lama atau jika baterai sudah lemah. Jangan gunakan baterai yang rusak. Gunakan hanya baterai alkali. Masukkan baterai dengan posisi kutub yang tepat. Jangan pernah coba mengisi ulang baterai biasa. Jangan pernah membuat arus pendek pada dudukan baterai.

## MS

### Maklumat penting tentang bateri

Jangan guna jenis bateri yang berbeza bersama-sama, atau gabungan bateri baharu dan lama. Tanggalkan bateri jika produk tidak akan digunakan untuk tempoh masa yang lama atau jika bateri telah kehabisan kuasa. Jangan guna bateri yang rosak. Guna bateri jenis alkali sahaja. Selitkan bateri supaya paksi berada pada kedudukan yang betul. Jangan cuba untuk mengecap semula bateri yang tidak boleh dicaskan semula. Jangan pintas litar pemegang bateri.

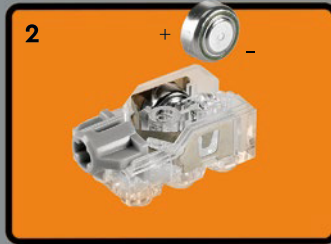

1:1  
2x LR 41 1.5V



EN  
WARNING: This product contains a Button or Coin Cell Battery.  
A swallowed Button or Coin Cell battery can cause internal chemical burns in as little as two hours and lead to death. Dispose of used batteries immediately. Keep new and used batteries away from children. If you think batteries might have been swallowed or placed inside any part of the body, seek immediate medical attention.

DE  
ACHTUNG: Dieses Produkt enthält eine Knopfzellenbatterie.  
Eine verschluckte Knopfzellenbatterie kann innere chemische Verbrennungen verursachen und in weniger als zwei Stunden zum Tod führen. Entsorge umgehend gebrauchte Batterien. Halte neue und gebrauchte Batterien von Kindern fern. Wenn du glaubst, dass Batterien verschluckt wurden oder sich in einem Körperteil befinden, hole umgehend medizinische Hilfe.

FR  
AVERTISSEMENT : Ce produit contient une pile bouton.  
L'ingestion d'une pile bouton peut provoquer des brûlures chimiques internes en seulement deux heures et provoquer la mort. Jeter immédiatement les piles usagées. Conserver les piles neuves et usagées hors de portée des enfants. Si vous suspectez l'ingestion d'une pile ou sa présence où que ce soit à l'intérieur du corps, consultez immédiatement un médecin.

IT  
ATTENZIONE: questo prodotto contiene una batteria a bottone.  
Se inghiottita, una batteria a bottone può causare ustioni chimiche interne in sole due ore, con possibile morte. Smaltire immediatamente le batterie usate. Tenere le batterie nuove e usate lontano dai bambini. Se si pensa che una batteria sia stata inghiottita o inserita in una parte del corpo, rivolgersi immediatamente a un medico.

NL  
WAARSCHUWING: dit product bevat een knoopcelbatterij.  
Als een knoopcelbatterij wordt ingeslikt, kan deze binnen twee uur chemische brandwonden veroorzaken in het lichaam. Het inslikken van een dergelijke batterij kan zelfs leiden tot overlijden. Gooi gebruikte batterijen onmiddellijk weg. Bewaar nieuwe en gebruikte batterijen buiten bereik van kinderen. Als je denkt dat een kind batterijen heeft ingeslikt of ze in een lichaamsopening heeft gestopt, raadpleeg je direct een arts.

ES  
ADVERTENCIA: Este producto contiene una pila de botón.  
Ingerir una pila de botón puede dar lugar a quemaduras químicas internas en tan sólo dos horas y provocar la muerte. Las pilas usadas deben desecharse inmediatamente. Mantenga las pilas nuevas y usadas fuera del alcance de los niños. Si sospecha de la ingestión o la introducción de pilas en cualquier parte del cuerpo, busque atención médica inmediatamente.

DA  
ADVARSEL: Dette produkt indeholder et knap- eller møntcellebatteri.  
Hvis et knap- eller møntcellebatteri sluges, kan det forårsage indvendige ætninger på blot to timer og medføre døden. Bortskaf brugte batterier omgående. Hold både nye og brugte batterier uden for børns rækkevidde. Hvis du har mistanke om, at batterierne kan være blevet slugt eller kommet ind i nogen del af kroppen, skal du omgående søge lægehjælp.

IS  
VIÐVÖRUN: Þessi vara inniheldur hnapparafhlöðu eða flata rafhlöðu.  
Ef hnapparafhlaða eða flöt rafhlaða er gleypt getur hún valdið innvortis efnabruna á innan við tveimur klukkustundum og leitt til dauða. Fargaðu notuðum rafhlöðum tafarlaust. Geymdu nýjar og notaðar rafhlöður þar sem börn ná ekki til. Ef þú telur að rafhlöður hafi verið gleyptar eða á annan hátt komist inn í einhverjum hluta líkamans skaltu tafarlaust leita lækniástoðar.

FI  
VAROITUS: Tämä tuote sisältää pienen tai isokokoisien nappipariston.  
Nieltynä pieni tai isokokoinen nappiparisto voi aiheuttaa sisäisiä kemiallisia palovammoja jo kahden tunnin kuluessa ja johtaa kuolemaan. Käytetyt paristot on toimitettava heti keräyspisteeseen. Pidä uudet ja käytetyt paristot poissa lasten ulottuvilta. Jos epäilet jonkun nielaissseen pariston tai laittaneensa pariston kehoonsa, vie hänet välittömästi lääkäriin.

SV  
VARNING: Denna produkt innehåller ett knapp- eller myntcells batteri.  
Förtäring av ett knapp- eller myntcells batteri kan orsaka inre kemiska brännskador på så kort tid som två timmar och leda till döden. Kasserat förbrukade batterier omedelbart. Förvara nya och använda batterier utom räckhåll för barn. Om du tror att batterierna kan ha svalts eller placerats inuti någon del av kroppen, sök omedelbart läkarvård.

NO  
ADVARSEL: Dette produktet inneholder et knapp- eller myntcellebatteri.  
Ved svelging kan knapp- eller myntcellebatterier gi kjemisk brannskade innvendig på bare to timer og føre til død. Brukte batterier skal avhendes øyeblikkelig. Nye og brukte batterier skal oppbevares utilgjengelig for barn. Hvis du tror at batterier har blitt svelget eller puttet inn andre steder i kroppen, må du kontakte lege øyeblikkelig.

PT  
AVISO: Este produto contém uma pilha tipo botão ou moeda.  
Uma pilha tipo botão ou moeda que tenha sido engolidada pode provocar queimaduras químicas internas em menos de duas horas e levar à morte. Elimine as pilhas usadas imediatamente. Mantenha as pilhas novas e usadas fora do alcance das crianças. Se pensa que as pilhas podem ter sido engolidas ou colocadas no interior de alguma parte do corpo, procure de imediato assistência médica.

EL  
ΠΡΟΕΙΔΟΠΟΙΗΣΗ: Αυτό το προϊόν περιέχει μία Στρογγυλή Μπαταρία Μεγέθους Κουμπιού ή Κέρματος.  
Η κατάποση μιας Στρογγυλής Μπαταρίας Μεγέθους Κουμπιού ή Κέρματος μπορεί να προκαλέσει εσωτερικά χημικά εγκαύματα σε μόλις δύο ώρες και να οδηγήσει σε θάνατο. Πετάξτε αμέσως τις χρησιμοποιημένες μπαταρίες. Κρατήστε τις καινούργιες και τις χρησιμοποιημένες μπαταρίες μακριά από τα παιδιά. Εάν νομίζετε ότι κάποια μπαταρία έχει καταποθεί ή τοποθετηθεί εντός οποιουδήποτε μέρους του σώματος, ζητήστε αμέσως ιατρική βοήθεια.



JA

警告: 本製品には、ボタン型またはコイン型の電池が使用されています。ボタン型またはコイン型電池は誤飲すると2時間以内に体内で科学火傷を起こし、死に至る恐れがあります。使用済みの電池は直ちに廃棄してください。新しい電池および使用済み電池は、どちらもお子様の手の届かないところに保管してください。電池を誤飲した恐れがある、または電池が身体のどこかに入った恐れがある場合は、直ちに医師の診察を受けてください。

ZH

警告: 本品内含一颗纽扣电池。吞咽的纽扣电池仅在两小时内就会引起体内化学灼伤并导致死亡! 请立即处理使用过的电池。请将新、旧电池放置到儿童接触不到的地方。如果电池被不慎吞下, 或被置入身体的任何一个部位, 请立即就医!

KO

경고: 이 제품에는 버튼 또는 코인 셀 배터리가 포함되어 있습니다. 코인 셀 배터리를 삼킬 경우, 빠르면 2시간 이내에 체내에서 화학적 화상이 일어나고 심하면 사망에 이를 수 있습니다. 다 쓴 배터리는 즉시 폐기하십시오. 배터리를 어린이의 손에 닿지 않는 곳에 보관하십시오. 배터리를 삼켰거나 신체 어느 부위에든 들어간 것으로 판단될 경우, 즉각 의사의 도움을 구하십시오.

RU

ПРЕДОСТЕРЕЖЕНИЕ. Эта игрушка работает от батарейки таблеточного или кнопочного типа. Проглатывание батарейки таблеточного или кнопочного типа может (в течение двух часов) вызвать химические ожоги внутренних органов и привести к летальному исходу. Своевременно утилизируйте использованные батарейки. Храните новые и использованные батарейки в местах, недоступных для детей. Если у вас есть основания полагать, что ребенок проглотил батарейку или она попала внутрь какой-либо части его тела, немедленно обратитесь за медицинской помощью.

PL

OSTRZEŻENIE: w tym produkcie znajduje się płaska okrągła bateria. Połknięcie takiej baterii może spowodować chemiczne oparzenia wewnętrzne już po dwóch godzinach, a także doprowadzić do śmierci. Gdy bateria się zużyje, należy ją natychmiast zutylizować. Nowe i używane baterie należy przechowywać z dala od dzieci. W przypadku stwierdzenia, że baterie mogły zostać połknięte lub inaczej trafić do organizmu, należy natychmiast poszukać pomocy lekarskiej.

CZ

VAROVÁNÍ: Tento výrobek obsahuje knoflíkovou nebo mincovou baterii. Spolknutí knoflíkové nebo mincové baterie může během pouhých 2 hodin způsobit vnitřní poleptání sliznice a v některých případech mít za následek smrt. Použité baterie ihned vyjměte a zlikvidujte. Nové i použité baterie uchovávejte mimo dosah dětí. V případě spolknutí či uviznutí baterie v některé části těla okamžitě vyhledejte lékařskou pomoc.

SK

UPOZORNENIE: Tento produkt obsahuje gombíkovú alebo mincovú batériu. Prehltnutie gombíkovej alebo mincovej batérie môže spôsobiť vnútorné chemické popáleniny už do dvoch hodín a viesť k úmrtiu. Použité batérie ihneď vyhod'te. Nové aj použité batérie uchovávajte mimo dosahu detí. Ak si myslíte, že mohlo dôjsť k prehltnutiu batérie alebo sa batéria mohla dostať do vnútra ktorejkoľvek časti tela, okamžite vyhľadajte lekársku pomoc.

HU

FIGYELMEZTETÉS: Ez a termék gomelemet illetve lapos gomelemet tartalmaz! A lenyelt gomelem vagy lapos gomelem akár két óra alatt is belső vegyi sérüléseket okozhat, ami halálhoz vezethet. Az elhasznált elemeket azonnal dobja ki! Az új és a használt elemeket ne adja gyermekek kezébe! Ha úgy gondolja, hogy valaki lenyelt egy elemet, vagy bekerült valakinek valamely testrészébe, akkor azonnal kérjen orvosi segítséget!

UA

ОБЕРЕЖНО. Продукт містить мініатюрну батарейку типу «таблетка». Якщо проковтнути мініатюрну батарейку, вона може спричинити внутрішні хімічні опіки протягом двох годин і призвести до смерті. Негайно утилізуйте використані батарейки. Зберігайте нові та використані батарейки недосяжними для дітей. Якщо вам здається, що дитина проковтнула батарейку чи вона опинилася в будь-якій частині тіла дитини, негайно зверніться до лікаря.

HR

UPOZORENJE: Ovaj proizvod sadrži gumbastu bateriju ili bateriju oblika kovanice. Ako se gumbasta baterija ili baterija oblika kovanice proguta, za samo dva sata može uzrokovati unutarnje kemijske opekline i izazvati smrt. Iskorištene baterije odmah odložite u otpad. Čuvajte nove i stare baterije dalje od djece. Ako mislite da je baterija progutana ili je dospjela u bilo koji dijel tijela, odmah zatražite liječničku pomoć.

SR

UPOZORENJE: Ovaј proizvod sadrži dугmаstu bateriju. Progutаnа dугmаstа baterijа mоže dа dоvede dо internih хемијских оpekотinа већ zа dва sаtа и dоvоdi dо smrti. Odmах оdložite iskоришћене bаteriје у оtpаd. Čuvајte nоve и iskоришћене bаteriје vаn dоmаšаја dеce. Аkо mislite dа је dоšlo dо gutaња bаteriја или stаvlјања u bילו kојi dео tеlа, оdmах pоtrаžite pоmоћ lеkаrа.

MK

ПРЕДУПРЕДУВАЊЕ: Овој производ содржи батерија тип копче или тип монета. Проголтувањето на батерија тип копче или тип монета може да предизвика внатрешно хемиско горење во рок од два часа и да доведе до смрт. Исфрлете ги веднаш искористените батерии. Држете ги новите и користените батерии подалеку од деца. Ако мислите дека е можно батерите да се проголтани или поставени во кој било дел на телото, веднаш побарајте медицинска помош.



SL

**OPOZORILO:** Ta izdelek vsebuje gumbasto baterijo.

Če oseba požre gumbasto baterijo, lahko to povzroči kemične opekline notranjih organov že v dveh urah po zaužitju. Tovrstne poškodbe lahko vodijo v smrt. Iztrošene baterije takoj zavrzite. Pazite, da nove ali iztrošene baterije ne bodo v dosegu otrok. Če menite, da je oseba zaužila baterijo ali si jo vstavila v kateri koli del telesa, takoj poiščite zdravniško pomoč.

RO

**AVERTIZARE:** Acest produs conține o baterie de tip pastilă.

Înghițirea unei baterii de tip pastilă poate cauza arsuri chimice interne în doar două ore, ducând la deces. Debarasați-vă imediat de bateriile uzate. Nu lăsați bateriile noi și uzate la îndemâna copiilor. Dacă credeți că bateriile ar fi putut fi înghițite sau ar fi putut ajunge în interiorul oricărei părți a corpului, solicitați imediat asistență medicală.

BG

**ПРЕДУПРЕЖДЕНИЕ:** Този продукт съдържа батерия тип „копче“ или „монета“.

При поглъщане батериите тип „копче“ или „монета“ могат да предизвикат вътрешни химически изгаряния в рамките на по-малко от два часа и да доведат до смърт. Незабавно изхвърляйте използваните батерии. Дръжте новите и стари батерии далеч от деца. Ако смятате, че е възможно батериите да са били погълнати или да са попаднали където и да е вътре в тялото, потърсете незабавно медицинска помощ.

LV

**BRĪDINĀJUMS.** Šim produktam ir pogas jeb monētas tipa akumulators.

Ja pogas jeb monētas tipa akumulators tiek norīts, tas jau divu stundu laikā var izraisīt iekšējus ķīmiskus apdegumus un izraisīt nāvi. Nekavējoties izlietojiet izlietotos akumulatorus. Jaunus un lietotus akumulatorus glabājiet bērniem nepieejamā vietā. Ja uzskatāt, ka akumulators varētu būt norīts vai ievietots kādā ķermeņa daļā, nekavējoties vērsieties pēc medicīniskās palīdzības.

ET

**HOIATUS!** See toode sisaldab nööp- või müntpatareid.

Alla neelatud nööp- või müntpatareid võib tekitada sisemisi keemilisi põletusi kõigest kahe tunni jooksul ning põhjustada surma. Kõrvaldage kasutatud patareid viivitamatult. Hoidke uusi ja kasutatud patareid lastele kättesaamatus kohas. Kui arvate, et keegi on patareid alla neelanud või need on sattunud mõnda kehaosasse, pöörduge kohe arsti poole.

LT

**JSPĖJIMAS.** Šiame gaminyje yra sagos arba monetos formos baterija.

Praryta sagos arba monetos formos baterija gali sukelti vidinius cheminius nudeginimus greičiau nei per dvi valandas ir galiausiai sukelti mirtį. Panaudotas baterijas nedelsiant utilizuokite. Naujas ir panaudotas baterijas laikykite atokiau nuo vaikų. Jei manote, kad vaikas galėjo praryti arba įsprausti bateriją sau į kūną, nedelsdami kreipkitės medicininės pagalbos.

TR

**UYARI:** Bu ürün bir düğme pil içerir.

Yutulmuş düğme pil, iki saat gibi kısa bir sürede iç kimyasal yanıklara neden olabilir ve ölüme yol açabilir. Kullanılmış pilleri derhal atın. Yeni ve kullanılmış pilleri çocuklardan uzak tutun. Pillerin yutulmuş ya da vücudun başka bir yerine sokulmuş olabileceğini düşünüyorsanız derhal doktora başvurun.

AR

تحذير: يحتوي هذا المنتج على بطارية خلايا قرصية أو بطارية خلايا على شكل عملة. قد يؤدي ابتلاع بطارية خلايا قرصية أو بطارية خلايا على شكل عملة إلى حدوث حروق كيميائية داخلية خلال فترة قصيرة لا تتجاوز ساعتين وقد يؤدي إلى الوفاة. يرجى التخلص من البطاريات المستعملة على الفور. مع الاحتفاظ بالبطاريات الجديدة والمستعملة بعيداً عن متناول الأطفال. إذا كنت تعتقد أن البطاريات تم ابتلاعها أو إدخالها إلى أي جزء من أجزاء الجسم، فاطلب المساعدة الطبية على الفور.

ID

**PERINGATAN:** Produk ini berisi Baterai Sel Kancing.

Baterai Sel Kancing yang tertelan dapat mengakibatkan luka bakar kimiawi dalam tubuh minimal setelah dua jam dan dapat mengakibatkan kematian. Segera buang baterai yang sudah tidak digunakan. Jauhkan baterai baru maupun bekas dari jangkauan anak-anak. Jika Anda curiga baterai telah tertelan atau masuk ke dalam tubuh, segeralah minta bantuan dokter.

MS

**AMARAN:** Produk ini mengandungi Bateri Sel Butang atau Syiling.

Tertelan bateri Sel Butang atau Syiling boleh mengakibatkan lecuran kimia dalaman dalam tempoh sekurang-kurangnya dua jam dan menyebabkan kematian. Buang bateri terpakai dengan serta-merta. Jauhkan bateri baharu dan terpakai daripada kanak-kanak. Jika anda mendapati bateri mungkin telah ditelan atau termasuk ke dalam mana-mana bahagian badan, dapatkan rawatan perubatan dengan segera.

EN Please retain the leaflet and packaging as they contain important information

DE Broschüre und Verpackung bitte aufbewahren, sie enthalten wichtige Informationen

FR Veuillez conserver le dépliant et l'emballage, car ils contiennent des informations importantes

IT Conserva l'opuscolo e la confezione in quanto contengono informazioni importanti

NL Bewaar a.u.b. de folder en verpakking: die bevatten belangrijke informatie

ES Conserve el folleto y el embalaje; contienen información importante

DA Gem hæftet og emballagen, da de indeholder vigtige oplysninger

IS Geymið bæklinginn og umbúðirnar þar sem þau innihalda mikilvægar upplýsingar

FI Säilytä esite ja pakkaus, koska ne sisältävät tärkeää tietoa

SV Spara broschyren och förpackningen eftersom de innehåller viktig information

NO Heftet og emballasjen inneholder viktig informasjon og skal beholdes

PT Por favor guarde o folheto e a embalagem, pois contém informação importante

EL Κρατήστε το φυλλάδιο και τη συσκευασία γιατί περιέχουν σημαντικές πληροφορίες

JA 説明書とパッケージには重要な情報が含まれていますので保管しておいてください

ZH 说明书和包装均包含重要信息, 请妥善保管

KO 중요한 정보가 담겨 있으므로 리플릿과 포장을 보관해주세요

RU Пожалуйста, сохраните эту брошюру и упаковку, поскольку они содержат важную информацию

PL Prosimy zachować ulotkę i opakowanie, ponieważ zawierają one ważne informacje

CZ Ponechte si prosím leták i obal, neboť obsahují důležité informace

SK Ponechajte si prosím leták aj obal, pretože obsahujú dôležité informácie

HU Kérjük, őrizze meg a szórólapot és a csomagolást, mert fontos tudnivalókat tartalmaznak

UA Будь ласка, зберігайте вкладиш та упаковку, оскільки вони містять важливу інформацію

HR Spremite letak i ambalažu jer sadrže važne obavijesti

SR Молимо да сачувате упутство и паковање јер се на њима налазе важне информације

MK Чувајте ги брошурата и амбалажата бидејќи содржат важна информација

SL Prosimo, da brošurico in embalažo shranite, saj vključujeta pomembne informacije

RO Vă rugăm să păstrați prospectul și ambalajul întrucât conțin informații importante

BG Запазете листовката и опаковката, тъй като съдържат важна информация

LV Lūdzu, saglabājiet bukletu un iepakojumu, jo uz tā ir norādīta svarīga informācija

ET Hoidke infoleht ja pakend alles, sest nendele on märgitud oluline teave

LT Išsaugokite informaciją lapelį ir pakuotę, nes ant jų pateikiama svarbi informacija

TR Önemli bilgiler içerdiği için broşürü ve ambalajı saklayın

AR الرجاء الاحتفاظ بالبشرة والغلاف لاحتوائهما على معلومات هامة

ID Harap simpan brosur dan kemasan ini karena berisi informasi penting

MS Sila simpan risalah dan pembungkusan kerana ia mengandungi maklumat penting

LEGO System A/S  
Aastvej 1  
DK-7190 Billund





EN

Protect the environment by not disposing of this product with your household waste.  
Check with your local authority for recycling advice and facilities. Penalties may apply for improper disposal.

DE

Schützen Sie die Umwelt und entsorgen Sie dieses Produkt nicht mit Ihrem Hausmüll.  
Informationen zu Recycling-Möglichkeiten erhalten Sie bei den örtlichen Behörden. Bei unsachgemäßer Entsorgung können Strafen verhängt werden.

FR

Protégez l'environnement : ne jetez pas ce produit avec vos autres déchets ménagers.  
Contactez les autorités locales pour obtenir des informations sur le recyclage et connaître les points de collecte. Des sanctions peuvent être appliquées en cas d'élimination inappropriée.



IT

Proteggi l'ambiente! Non smaltire questo prodotto con i rifiuti domestici.  
Per consulenza sul riciclaggio dei rifiuti e le strutture di riciclaggio, rivolgersi alle proprie autorità locali. Uno smaltimento improprio può comportare sanzioni.

NL

Bescherm het milieu: gooi dit product niet samen met het andere huisvuil weg.  
Raadpleeg de plaatselijke instanties voor locaties van milieustations en advies over hergebruik. In geval van onjuiste verwijdering kunnen boetes worden opgelegd.

ES

Proteja el medio ambiente no deshaciéndose de este producto junto con sus residuos domésticos.  
Solicite asesoramiento e información sobre instalaciones de reciclaje a las autoridades locales. La eliminación inadecuada puede ser objeto de sanciones.

DA

Beskyt miljøet! Smid ikke dette produkt ud sammen med husholdningsaffaldet.  
Få vejledning om genbrug og genbrugsstationer hos din kommune. Ukorrekt bortskaffelse kan medføre bøde eller straf.

IS

Stuðlið að umhverfisvernd með því að farga þessari vöru ekki með heimilissorpi.  
Leitið upplýsinga um endurvinnslu- og förgunarstaði hjá yfirvöldum á hverjum stað. Viðurlögum kann að vera beitt ef förgun er ekki með réttum hætti.

FI

Tämä tuote on hävitettävä ympäristöystävällisesti ja erillään muusta talousjätteestä.  
Tietoja kierrätyksestä ja keräyspisteiden sijainnista saat paikkakuntasi teknisestä virastosta. Epäasianmukaisesta hävittämisestä saattaa aiheutua seuraamuksia.

SV

Skydda miljön genom att inte kasta denna produkt bland ditt hushållsavfall.  
Kontakta din kommun för frågor om återvinning och miljöstationer. Påföljder kan tillkomma för felaktigt avyttring.

NO

Beskytt miljøet. Ikke kast dette produktet i husholdningsavfall.  
Kontakt kommunen for veiledning om gjenbruk og miljøstasjoner. Feil avfallshåndtering kan være straffbart.

PT

Proteja o ambiente não eliminando este produto com o seu lixo doméstico.  
Consulte as autoridades locais para informação sobre reciclagem e sistemas de recolha. Podem ser aplicadas coimas por eliminação inadequada.

EL

Προστατέψτε το περιβάλλον. Μην πετάτε αυτό το προϊόν μαζί με τα συνηθισμένα οικιακά απορρίμματα.  
Επικοινωνήστε με τις τοπικές αρχές σχετικά με συμβουλές και εγκαταστάσεις ανακύκλωσης. Ενδέχεται να επιβάλλονται κυρώσεις για ακατάλληλη διάθεση απορριμμάτων.

JA

環境保護のため、本製品は家庭ごみとは別に処分してください。  
リサイクルに関する指示や施設については、お住まいの地方自治体にお問い合わせください。不適切な廃棄を行った場合、罰則が適用されることがあります。

ZH

注意保护环境，请勿将本产品与生活垃圾一起丢弃处理。  
请咨询当地相关部门，了解与回收相关的设施与建议。  
处理不当可能会导致处罚。

KO

환경 보호를 위해 이 제품을 생활폐기물과 함께 버리지 마십시오.  
재활용 방법 및 시설에 관한 사항은 현지 관계 당국에 문의하십시오. 부적절하게 폐기할 경우 벌칙이 부과될 수 있습니다.

RU

Позаботьтесь об окружающей среде: не утилизируйте этот продукт вместе с бытовым мусором.  
Узнайте в органах местного самоуправления правила вторичной переработки и утилизации таких отходов.  
В случае ненадлежащей утилизации могут быть наложены штрафы.



PL

Aby chronić środowisko naturalne, nie należy wyrzucać tego produktu wraz z odpadkami z gospodarstwa domowego.  
W celu uzyskania wskazówek dotyczących recyklingu oraz adresów zakładów należy skontaktować się z lokalnym urzędem.  
Za nieprzestrzeganie zasad związanych z utylizacją odpadów grożą kary.

CZ

Nevyhazujte tento produkt do domácího odpadu, chráňte životní prostředí. Zjistěte si prosím u místních úřadů možnosti recyklace a dostupná zařízení. Nesprávná likvidace může být pokutována.

SK

Nevyhadzujte tento produkt do domáceho odpadu, chráňte životné prostredie. Zistite si na miestnych úradoch možnosti recyklácie a dostupné zariadenia. Za nesprávnu likvidáciu môžu byť uložené sankcie.

HU

Környezetét óvja, ha ettől a terméktől nem a háztartási hulladékkal együtt válik meg.  
Érdeklődjék a lakóhelyéhez közel eső hatóságnál az újrahasznosítás módjáról és lehetőségeiről. A nem megfelelő hulladékelhelyezésért büntetés járhat.

UA

Допоможіть захистити довкілля: не утилізуйте цей виріб разом із побутовим сміттям.  
Вказівки з утилізації та відомості про пункти прийому з'ясуєте в місцевих компетентних органів. У разі неналежної утилізації можуть застосовуватися штрафи.

HR

Zaštitite okoliš tako da ovaj proizvod ne odložite u otpad zajedno s kućanskim otpadom.  
Od lokalnih vlasti zatražite savjet ili informacije o pogonima za recikliranje. Moгуća je kazna za nepropisno zbrinjavanje.

SR

Zaštitite životnu sredinu tako što nećete da odlažete ovaj proizvod sa kućnim otpadom.  
Raspitajte se kod lokalnog nadležnog organa o načinu reciklaže i o sabirnom centru. U slučaju nepravilnog odlaganja u otpad, mogu biti izrečene kazne.

MK

Zaštitete ja okolinata tako što nema da se oslobodite od proizvodot so domashniot otpad.  
Konsultirajte se so lokalnite vlasti za da doznaete za sovetite i objektite za recikliranje. Vozmožno e da bidat primeneti kazni za nepravilno isflanje.

SL

Zaščitite okolje! Okolje varujte tako, da tega izdelka ne zavržete skupaj z gospodinjiskimi odpadki.  
Pri krajevni upravi preverite, kakšne možnosti in kateri obrati za recikliranje obstajajo v vaši okolici. Za nepravilno odlaganje odpadkov vas lahko doleti kazen.

RO

Protejați mediul înconjurător și nu vă debarașați de acest produs împreună cu deșeurile menajere  
Consultați autoritățile locale pentru îndrumări și facilități de reciclare.  
Dezafectarea necorespunzătoare poate atrage sancțiuni.

BG

Защитете околната среда и не изхвърляйте този продукт заедно с битовите си отпадъци.  
Свържете се с местните власти относно съвети и съоръжения за рециклиране. Възможно е да има глоби за неправилно изхвърляне.

LV

Lai saudzētu vidi, neizmetiet šo izstrādājumu kopā ar sadzīves atkritumiem. Vērsieties vietējās varas iestādēs, lai noskaidrotu, kur un kā tas nododams pārstrādei. Par neatbilstošu likvidēšanu var tikt piemērots sods.

ET

Keskkonda saate kaitsta nii, et ei kõrvalda seda toodet koos olmejäätmetega.  
Nõuandeid toote taaskasutusse võtmise ja ümbertöötlemispunktide kohta saate asjaomaselt kohalikult asutuselt.  
Nõuetele mittevastav kasutuselt kõrvaldamine võib kaasa tuua trahvid.

LT

Saugokite aplinką: nemeskite šio produkto kartu su buitinių atliekomis. Atsižvelkite į savo vietos valdžios rekomendacijas dėl pakartotinio panaudojimo ir sąlygas. Už netinkamą šalinimą gali būti taikomos baudos.

TR

Bu ürünü, evsel atıklarla birlikte atmayarak çevreyi koruyun.  
Gerі dönüşüm tavsiyeleri ve tesisler hakkında bilgi için yerel yönetimle iletişim kurun. Uygunsuз atılması durumunda cezalar uygulanabilir.

AR

احم البيئة بعدم التخلص من هذا المنتج مع المخلفات المنزلية.  
استشر السلطة المحلية لديك للحصول على نصيح بخصوص إعادة تدوير المخلفات ومراقفه.  
قد يتم تطبيق عقوبات على التخلص غير السليم.

ID

Jagalah lingkungan dengan tidak membuang produk ini bersama sampah rumah tangga Anda.  
Periksa peraturan pemerintah setempat tentang saran dan fasilitas daur ulang. Pembuangan yang tidak sesuai ketentuan dapat dikenakan denda.

MS

Lindungi alam sekitar dengan tidak melupuskan produk ini bersama sisa isi rumah anda.  
Rujuk pihak berkuasa tempatan anda tentang nasihat dan kemudahan kitar semula. Penalti boleh dikenakan untuk pelupusan yang tidak wajar.



# YOU COULD WIN



## YOU COULD WIN

Your feedback will help shape the future development of this product series.

Visit:

## DU KÖNNTEST GEWINNEN

Dein Feedback trägt zur Weiterentwicklung dieser Produktreihe bei.

Geh auf:

## VOUS POURRIEZ GAGNER

Vos commentaires nous aideront à concevoir les futurs produits de cette gamme.

Visitez :

## POTRESTI VINCERE TU

La tua opinione ci aiuterà a migliorare la creazione futura di questa linea di prodotti.

Visita:

## PUEDES GANAR

Tu opinión contribuirá al futuro de esta serie de productos.

Visita:

## 轻松获奖

您的反馈将有助于我们在今后改进本产品系列。

请访问:

---

**[LEGO.com/productfeedback](https://www.lego.com/productfeedback)**

---

You also have the chance to win a LEGO® set.

Terms and conditions apply.\*

Außerdem hast du die Chance, ein LEGO® Set zu gewinnen.

Es gelten die Teilnahmebedingungen.\*

Vous pourriez également gagner un ensemble LEGO®.

Des conditions s'appliquent.\*

Hai anche la possibilità di vincere un set LEGO®.

Termini e condizioni sono applicabili.\*

También tienes la oportunidad de ganar un set LEGO®.

Aplican términos y condiciones.\*

您还有机会赢取乐高®套装。

条款和条件适用。\*

\*[LEGO.com/productfeedback-terms](https://www.lego.com/productfeedback-terms)

- 1x 6052864
- 2x 6224811
- 1x 4544140
- 4x 6436479
- 2x 403201
- 2x 4278271
- 2x 6310185
- 1x 306901
- 3x 6097637
- 1x 6446017
- 1x 6436480
- 1x 6446019
- 2x 4514842
- 2x 302201
- 1x 300301
- 1x 6218822
- 9x 6289797
- 4x 6284573
- 3x 4161734
- 4x 4118793
- 8x 4516055
- 3x 4565452
- 5x 4666579
- 12x 4624086
- 4x 6321305
- 1x 4114084
- 66x 6116614
- 3x 4114309
- 2x 6351905
- 2x 6036487
- 2x 6030980
- 2x 6170487
- 4x 306221
- 2x 6223427
- 3x 6271820
- 113x 6378120
- 1x 6397571
- 6x 6170390
- 1x 4504379
- 3x 302421
- 1x 407021
- 2x 6360104
- 2x 6399645
- 2x 4651524
- 3x 403221
- 2x 4142865
- 1x 4585146
- 4x 6029946
- 26x 302321
- 4x 6117974
- 12x 6001806
- 2x 6441098
- 4x 6360036
- 4x 6351892
- 9x 6061711
- 2x 6435045
- 1x 6251410
- 2x 4533742
- 1x 6371957
- 1x 6330205
- 4x 6129995
- 3x 371021
- 1x 4560179
- 3x 300121
- 1x 6371582
- 4x 300921
- 4x 379521
- 6x 6335578
- 1x 6130004
- 1x 4529235
- 4x 4504380
- 12x 6302961
- 4x 302423
- 1x 6396479
- 4x 4651236
- 8x 403223
- 2x 4206482
- 68x 6436474
- 4x 6092582
- 8x 6055065
- 3x 393723
- 2x 306923
- 4x 370023
- 2x 300423
- 1x 302323
- 1x 243223
- 1x 6133720
- 1x 6224999
- 3x 6279026
- 14x 6436477
- 20x 6299413
- 2x 6436476
- 1x 6116786
- 4x 6441096
- 21x 6436475
- 6x 4587840
- 2x 6436478
- 6x 6292291
- 2x 4560180
- 2x 4656767
- 4x 4118785
- 1x 366623
- 3x 379523
- 2x 300823
- 2x 447723
- 4x 383223
- 7x 6271167
- 2x 614124
- 1x 6284577
- 1x 6434831
- 4x 4624985
- 22x 300524
- 6x 302424
- 4x 307024
- 3x 654124
- 4x 6330893
- 1x 4550348
- 1x 6331822
- 22x 300424
- 52x 302324
- 2x 6167223
- 2x 6441088
- 2x 6361082
- 3x 6206240
- 4x 306924
- 6x 6375518
- 1x 6173122
- 1x 6310247
- 1x 6273711
- 4x 6079007
- 6x 242024
- 11x 300324

4

8

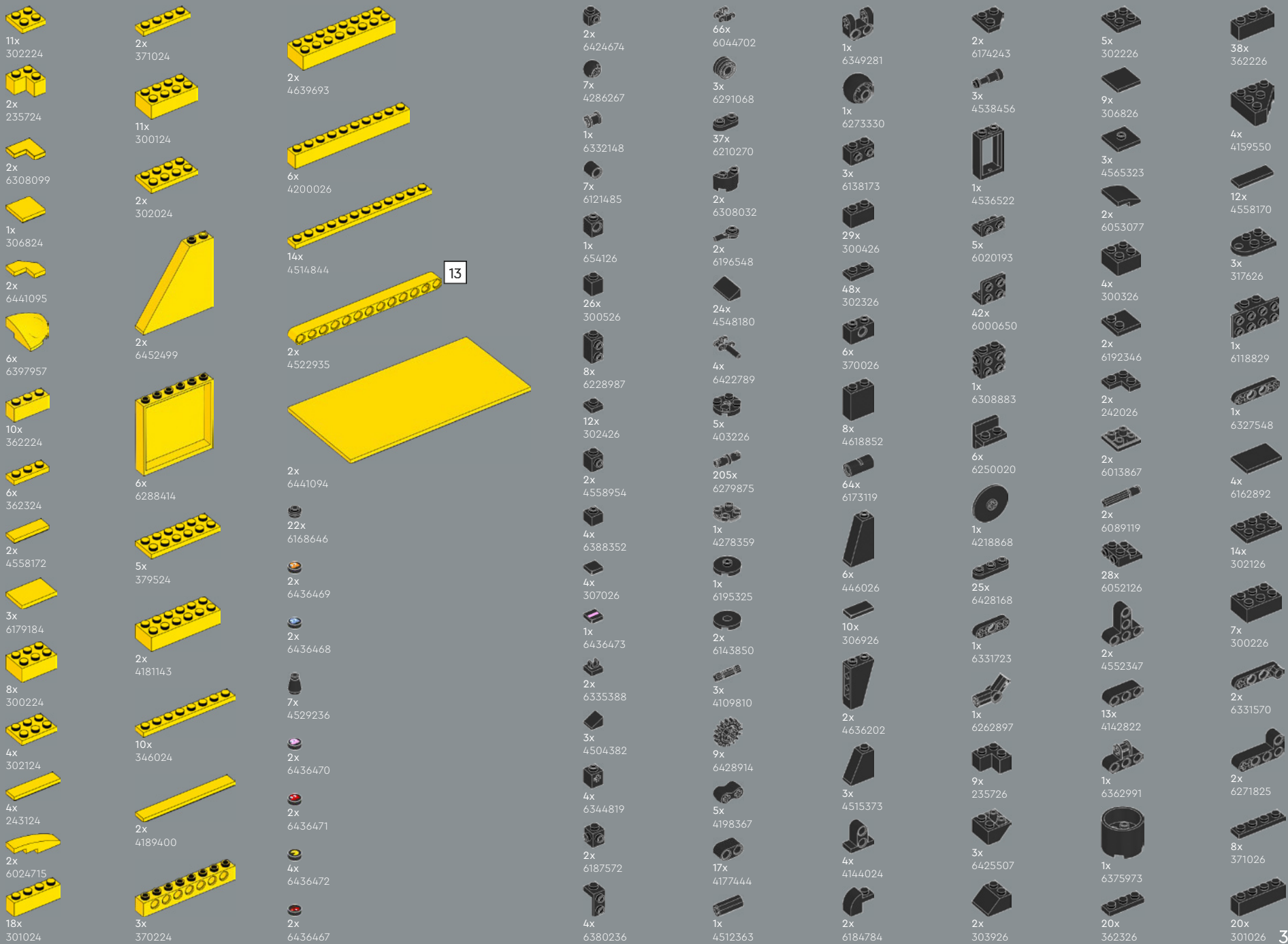

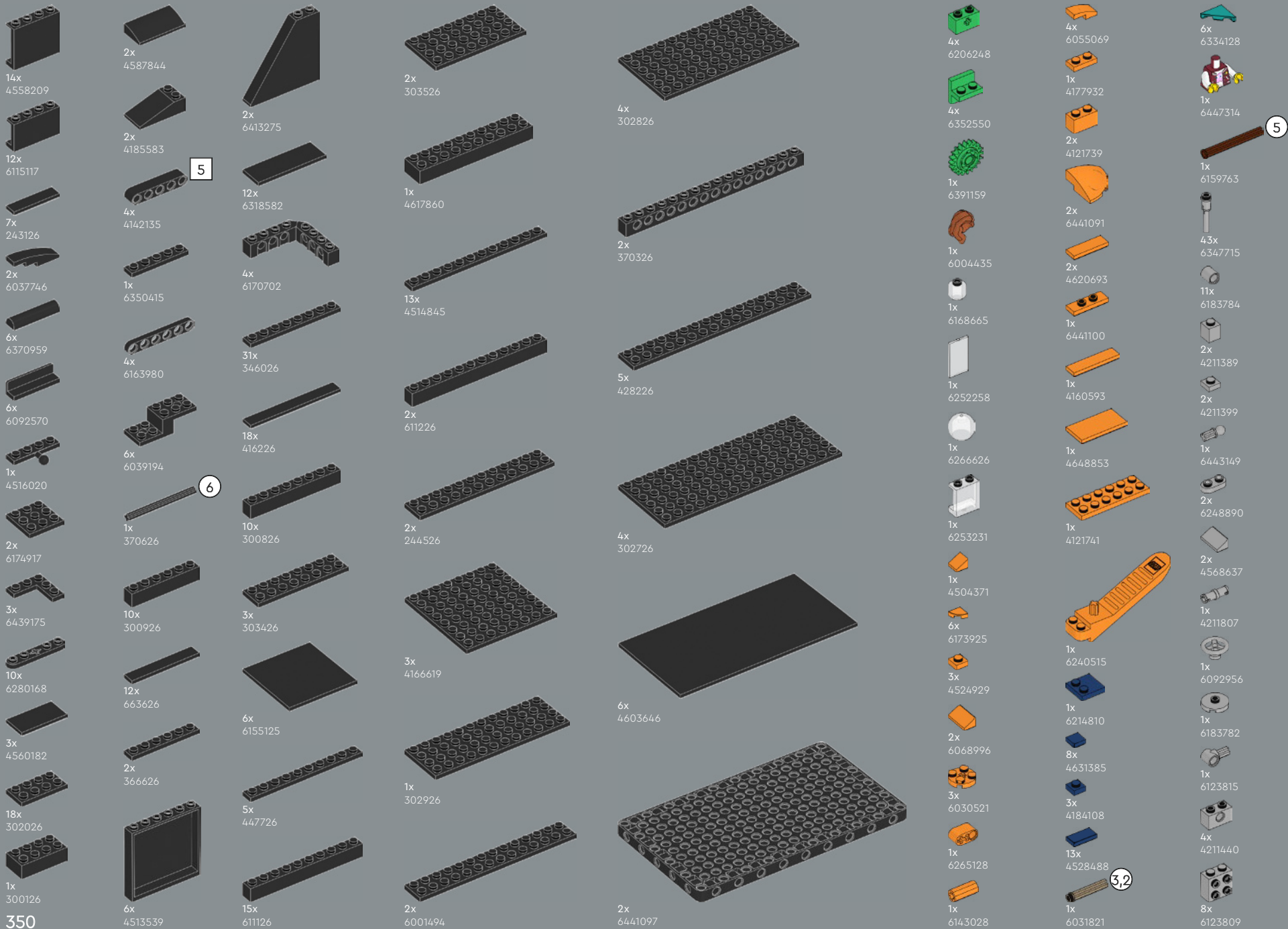

14x 4558209  
12x 6115117  
7x 243126  
2x 6037746  
6x 6370959  
6x 6092570  
1x 4516020  
2x 6174917  
3x 6439175  
10x 6280168  
3x 4560182  
18x 302026  
1x 300126

2x 4587844  
2x 4185583  
4x 4142135  
1x 6350415  
4x 6163980  
6x 6039194  
1x 370626  
10x 300926  
12x 663626  
2x 366626  
6x 4513539

2x 6413275  
12x 6318582  
4x 6170702  
31x 346026  
18x 416226  
10x 300826  
3x 303426  
6x 6155125  
5x 447726  
15x 611126

2x 303526  
1x 4617860  
13x 4514845  
2x 611226  
2x 244526  
3x 4166619  
1x 302926  
2x 6001494

4x 302826  
2x 370326  
5x 428226  
4x 302726  
6x 4603646  
2x 6441097

4x 6206248  
4x 6352550  
1x 6391159  
1x 6004435  
1x 6168665  
1x 6252258  
1x 6266626  
1x 6253231  
1x 4504371  
6x 6173925  
3x 4524929  
2x 6068996  
3x 6030521  
1x 6265128  
1x 6143028

4x 6055069  
1x 4177932  
2x 4121739  
2x 6441091  
2x 4620693  
1x 6441100  
1x 4160593  
1x 4648853  
1x 4121741  
1x 6240515  
1x 6214810  
2x 4631385  
3x 4184108  
13x 4528488  
1x 6031821

6x 6334128  
1x 6447314  
1x 6159763  
43x 6347715  
11x 6183784  
2x 4211389  
2x 4211399  
1x 6443149  
2x 6248890  
2x 4568637  
1x 4211807  
1x 6092956  
1x 6183782  
1x 6123815  
4x 4211440  
8x 6123809

5

6

3,2

5

24x  
4211541

2x  
6093859

6x  
4211397

3x  
6326478

3x  
6435857

1x  
4211815

3x  
4211881

2x  
4515369

1x  
6346487

1x  
6457283

4x  
4211452

2x  
6037399

1x  
4211406

4x  
4211636

5x  
4211445

1x  
4211441

1x  
6273218

3x  
4211527

3x  
4211395

2x  
4211639

3x  
6195314

1x  
6372029

2x  
4211438

2x  
4211407

2x  
4211860

1x  
4211366

6x  
4211486

2x  
6096589

2x  
4211115

6x  
4210997

4x  
4211067

2x  
4210794

1x  
4256149

2x  
6012451

2x  
4211044

2x  
6364352

3x  
6350724

2x  
6261374

2x  
6135014

1x  
6039479

1x  
6316692

2x  
4211060

11x  
4211000

12x  
4211094

9x  
4211055

3x  
6126083

4x  
6015356

2x  
6133119

4x  
4211043

1x  
6396057

1x  
6368313

2x  
6336665

2x  
6083620

2x  
4210725

3x  
6335115

2x  
4227398

3x  
4508553

1x  
4629920

8x  
4211056

3x  
4499858

2x  
4211008

1x  
6429475

1x  
6329604

3x  
6097493

4x  
6092674

6x  
6348141

1x  
6119107

2x  
4625036

3x  
6074793

1x  
6051507

2x  
6227958

3

5

4

5,5

8

 [LEGO.com/service](https://LEGO.com/service)



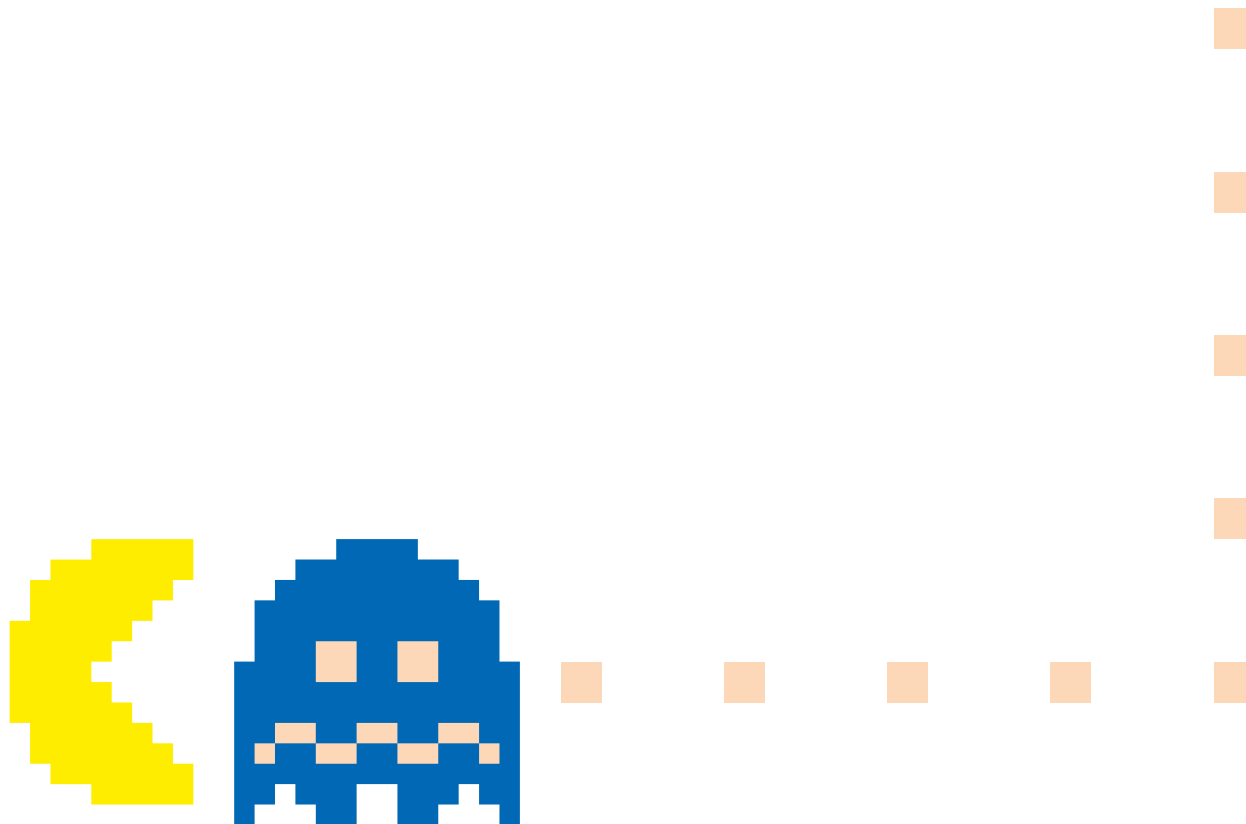

LEGO and the LEGO logo are trademarks of the/sont des marques de commerce du/  
son marcas registradas de LEGO Group. ©2023 The LEGO Group. 6500664

PAC-MAN™ & ©Bandai Namco Entertainment Inc.